



AMD64 Technology

AMD64 Architecture Programmer's Manual

Volume 2: System Programming

Publication No.	Revision	Date
24593	3.14	September 2007

© 2002 — 2007 Advanced Micro Devices, Inc. All rights reserved.

The contents of this document are provided in connection with Advanced Micro Devices, Inc. (“AMD”) products. AMD makes no representations or warranties with respect to the accuracy or completeness of the contents of this publication and reserves the right to make changes to specifications and product descriptions at any time without notice. The information contained herein may be of a preliminary or advance nature and is subject to change without notice. No license, whether express, implied, arising by estoppel or otherwise, to any intellectual property rights is granted by this publication. Except as set forth in AMD’s Standard Terms and Conditions of Sale, AMD assumes no liability whatsoever, and disclaims any express or implied warranty, relating to its products including, but not limited to, the implied warranty of merchantability, fitness for a particular purpose, or infringement of any intellectual property right.

AMD’s products are not designed, intended, authorized or warranted for use as components in systems intended for surgical implant into the body, or in other applications intended to support or sustain life, or in any other application in which the failure of AMD’s product could create a situation where personal injury, death, or severe property or environmental damage may occur. AMD reserves the right to discontinue or make changes to its products at any time without notice.

Trademarks

AMD, the AMD arrow logo, AMD Athlon, and AMD Opteron, and combinations thereof, AMD Virtualization and 3DNow! are trademarks, and AMD-K6 is a registered trademark of Advanced Micro Devices, Inc.

MMX is a trademark and Pentium is a registered trademark of Intel Corporation.

Windows NT is a registered trademark of Microsoft Corporation.

HyperTransport is a licensed trademark of the HyperTransport Technology Consortium.

Other product names used in this publication are for identification purposes only and may be trademarks of their respective companies.

Contents

Revision History	xxv
Preface	xxvii
About This Book	xxvii
Audience	xxvii
Organization	xxvii
Definitions	xxix
Terms and Notation	xxix
Registers	xxxvi
Endian Order	xxxix
Related Documents	xxxix
1 System-Programming Overview	1
1.1 Memory Model	1
Memory Addressing	2
Memory Organization	3
Canonical Address Form	4
1.2 Memory Management	5
Segmentation	5
Paging	7
Mixing Segmentation and Paging	8
Real Addressing	10
1.3 Operating Modes	11
Long Mode	12
64-Bit Mode	13
Compatibility Mode	13
Legacy Modes	14
System Management Mode (SMM)	15
1.4 System Registers	15
1.5 System-Data Structures	17
1.6 Interrupts	19
1.7 Additional System-Programming Facilities	20
Hardware Multitasking	20
Machine Check	21
Software Debugging	21
Performance Monitoring	22
2 x86 and AMD64 Architecture Differences	23
2.1 Operating Modes	23
Long Mode	23
Legacy Mode	23
System-Management Mode	24
2.2 Memory Model	24
Memory Addressing	24
Page Translation	25

	Segmentation	26
2.3	Protection Checks	27
2.4	Registers	28
	General-Purpose Registers	28
	128-Bit Media Registers	28
	Flags Register	28
	Instruction Pointer	28
	Stack Pointer	28
	Control Registers	29
	Debug Registers	29
	Extended Feature Register (EFER)	29
	Memory Type Range Registers (MTRRs)	29
	Other Model-Specific Registers (MSRs)	29
2.5	Instruction Set	29
	REX Prefixes	29
	Segment-Override Prefixes in 64-Bit Mode	30
	Operands and Results	30
	Address Calculations	30
	Instructions that Reference RSP	31
	Branches	32
	NOP Instruction	34
	Single-Byte INC and DEC Instructions	34
	MOVSXD Instruction	34
	Invalid Instructions	34
	FXSAVE and FXRSTOR Instructions	36
2.6	Interrupts and Exceptions	36
	Interrupt Descriptor Table	36
	Stack Frame Pushes	37
	Stack Switching	37
	IRET Instruction	37
	Task-Priority Register (CR8)	38
	New Exception Conditions	38
2.7	Hardware Task Switching	38
2.8	Long-Mode vs. Legacy-Mode Differences	38
3	System Resources	41
3.1	System-Control Registers	41
	CR0 Register	42
	CR2 and CR3 Registers	45
	CR4 Register	47
	CR1 and CR5–CR7 Registers	50
	64-Bit-Mode Extended Control Registers	50
	CR8 (Task Priority Register, TPR)	50
	RFLAGS Register	50
	Extended Feature Enable Register (EFER)	54
3.2	Model-Specific Registers (MSRs)	56
	System Configuration Register (SYSCFG)	57
	System-Linkage Registers	58

	Memory-Typing Registers	59
	Debug-Extension Registers	60
	Performance-Monitoring Registers	60
	Machine-Check Registers	60
3.3	Processor Feature Identification	61
4	Segmented Virtual Memory	63
4.1	Real Mode Segmentation	63
4.2	Virtual-8086 Mode Segmentation	64
4.3	Protected Mode Segmented-Memory Models	64
	Multi-Segmented Model	64
	Flat-Memory Model	65
	Segmentation in 64-Bit Mode	65
4.4	Segmentation Data Structures and Registers	65
4.5	Segment Selectors and Registers	67
	Segment Selectors	67
	Segment Registers	68
	Segment Registers in 64-Bit Mode	70
4.6	Descriptor Tables	71
	Global Descriptor Table	71
	Global Descriptor-Table Register	72
	Local Descriptor Table	73
	Local Descriptor-Table Register	74
	Interrupt Descriptor Table	76
	Interrupt Descriptor-Table Register	77
4.7	Legacy Segment Descriptors	77
	Descriptor Format	77
	Code-Segment Descriptors	80
	Data-Segment Descriptors	81
	System Descriptors	83
	Gate Descriptors	84
4.8	Long-Mode Segment Descriptors	86
	Code-Segment Descriptors	86
	Data-Segment Descriptors	87
	System Descriptors	88
	Gate Descriptors	90
	Long Mode Descriptor Summary	92
4.9	Segment-Protection Overview	93
	Privilege-Level Concept	94
	Privilege-Level Types	94
4.10	Data-Access Privilege Checks	95
	Accessing Data Segments	95
	Accessing Stack Segments	96
4.11	Control-Transfer Privilege Checks	98
	Direct Control Transfers	98
	Control Transfers Through Call Gates	102
	Return Control Transfers	109
4.12	Limit Checks	110

	Determining Limit Violations	110
4.13	Type Checks	112
	Type Checks in Legacy and Compatibility Modes	112
	Long Mode Type Check Differences	113
5	Page Translation and Protection	115
5.1	Page Translation Overview	115
	Page-Translation Options	118
	Page-Translation Enable (PG) Bit	118
	Physical-Address Extensions (PAE) Bit	119
	Page-Size Extensions (PSE) Bit	119
	Page-Directory Page Size (PS) Bit	119
5.2	Legacy-Mode Page Translation	120
	CR3 Register	120
	Normal (Non-PAE) Paging	121
	PAE Paging	124
5.3	Long-Mode Page Translation	128
	Canonical Address Form	128
	CR3	128
	4-Kbyte Page Translation	129
	2-Mbyte Page Translation	132
	1-Gbyte Page Translation	133
5.4	Page-Translation-Table Entry Fields	135
	Field Definitions	136
	Notes on Access and Dirty Bits	139
5.5	Translation-Lookaside Buffer (TLB)	139
	Global Pages	140
	TLB Management	140
5.6	Page-Protection Checks	142
	No Execute (NX) Bit	143
	User/Supervisor (U/S) Bit	143
	Read/Write (R/W) Bit	144
	Write Protect (CR0.WP) Bit	144
5.7	Protection Across Paging Hierarchy	144
	Access to User Pages when CR0.WP=1	146
5.8	Effects of Segment Protection	146
6	System-Management Instructions	147
6.1	Fast System Call and Return	149
	SYSCALL and SYSRET	150
	SYSENTER and SYSEXIT (Legacy Mode Only)	152
	SWAPGS Instruction	152
6.2	System Status and Control	153
	Processor Feature Identification (CPUID)	153
	Accessing Control Registers	153
	Accessing the RFLAGS Register	154
	Accessing Debug Registers	154
	Accessing Model-Specific Registers	154

6.3	Segment Register and Descriptor Register Access	154
	Accessing Segment Registers	155
	Accessing Descriptor-Table Registers	155
6.4	Protection Checking	155
	Checking Access Rights	156
	Checking Segment Limits	156
	Checking Read/Write Rights	156
	Adjusting Access Rights	156
6.5	Processor Halt	156
6.6	Cache and TLB Management	157
	Cache Management	157
	TLB Invalidation	157
7	Memory System	159
7.1	Single-Processor Memory Access Ordering	162
	Read Ordering	162
	Write Ordering	163
	Read/Write Barriers	163
7.2	Multiprocessor Memory Access Ordering	164
7.3	Memory Coherency and Protocol	167
	Special Coherency Considerations	169
7.4	Memory Types	170
	Memory Barrier Interaction with Memory Types	172
7.5	Buffering and Combining Memory Writes	174
	Write Buffering	174
	Write Combining	175
7.6	Memory Caches	176
	Cache Organization and Operation	176
	Cache Control Mechanisms	179
	Cache and Memory Management Instructions	181
	Serializing Instructions	182
7.7	Memory-Type Range Registers	183
	MTRR Type Fields	183
	MTRRs	184
	Using MTRRs	190
	MTRRs and Page Cache Controls	191
	MTRRs in Multi-Processing Environments	193
7.8	Page-Attribute Table Mechanism	193
	PAT Register	193
	PAT Indexing	194
	Identifying PAT Support	195
	PAT Accesses	195
	Combined Effect of MTRRs and PAT	196
	PATs in Multi-Processing Environments	197
7.9	Memory-Mapped I/O	197
	Extended Fixed-Range MTRR Type-Field Encodings	197
	IORRs	199
	IORR Overlapping	201

	Top of Memory	201
8	Exceptions and Interrupts.	205
8.1	General Characteristics	205
	Precision	205
	Instruction Restart	206
	Types of Exceptions.	206
	Masking External Interrupts	207
	Masking Floating-Point and Media Instructions	207
	Disabling Exceptions.	207
8.2	Vectors.	208
	#DE—Divide-by-Zero-Error Exception (Vector 0).	211
	#DB—Debug Exception (Vector 1).	211
	NMI—Non-Maskable-Interrupt Exception (Vector 2)	212
	#BP—Breakpoint Exception (Vector 3)	212
	#OF—Overflow Exception (Vector 4).	213
	#BR—Bound-Range Exception (Vector 5)	213
	#UD—Invalid-Opcode Exception (Vector 6)	213
	#NM—Device-Not-Available Exception (Vector 7)	214
	#DF—Double-Fault Exception (Vector 8).	214
	Coprocessor-Segment-Overrun Exception (Vector 9).	215
	#TS—Invalid-TSS Exception (Vector 10).	216
	#NP—Segment-Not-Present Exception (Vector 11)	217
	#SS—Stack Exception (Vector 12)	218
	#GP—General-Protection Exception (Vector 13)	218
	#PF—Page-Fault Exception (Vector 14).	219
	#MF—x87 Floating-Point Exception-Pending (Vector 16).	220
	#AC—Alignment-Check Exception (Vector 17).	221
	#MC—Machine-Check Exception (Vector 18)	222
	#XF—SIMD Floating-Point Exception (Vector 19)	223
	User-Defined Interrupts (Vectors 32–255).	223
8.3	Exceptions During a Task Switch	224
8.4	Error Codes	224
	Selector-Error Code	225
	Page-Fault Error Code	225
8.5	Priorities.	226
	Floating-Point Exception Priorities	227
	External Interrupt Priorities	228
8.6	Real-Mode Interrupt Control Transfers	229
8.7	Legacy Protected-Mode Interrupt Control Transfers	231
	Locating the Interrupt Handler	232
	Interrupt To Same Privilege.	233
	Interrupt To Higher Privilege.	234
	Privilege Checks	235
	Returning From Interrupt Procedures	238
8.8	Virtual-8086 Mode Interrupt Control Transfers	238
	Protected-Mode Handler Control Transfer	239
	Virtual-8086 Handler Control Transfer	241

8.9	Long-Mode Interrupt Control Transfers	241
	Interrupt Gates and Trap Gates	241
	Locating the Interrupt Handler	242
	Interrupt Stack Frame	243
	Interrupt-Stack Table	245
	Returning From Interrupt Procedures	246
8.10	Virtual Interrupts	247
	Virtual-8086 Mode Extensions	248
	Protected Mode Virtual Interrupts	251
	Effect of Instructions that Modify EFLAGS.IF	251
9	Machine Check Mechanism	255
9.1	Determining Machine-Check Support	255
9.2	Machine-Check Errors	255
	Error Sources	256
9.3	Machine Check MSRs	256
	Global Status and Control Registers	257
	Error-Reporting Register Banks	260
	Error Codes	262
9.4	Initializing the Machine-Check Mechanism	267
9.5	Using Machine Check Features	267
	Handling Machine Check Exceptions	268
	Reporting Correctable Machine Check Errors	269
10	System-Management Mode	271
10.1	SMM Differences	271
10.2	SMM Resources	272
	SMRAM	272
	SMBASE Register	273
	SMRAM State-Save Area	274
	SMM-Revision Identifier	278
	SMRAM Protected Area	279
10.3	Using SMM	281
	System-Management Interrupt (SMI)	281
	SMM Operating-Environment	281
	Exceptions and Interrupts	282
	Invalidating the Caches	283
	Saving Additional Processor State	283
	Operating in Protected Mode and Long Mode	284
	Auto-Halt Restart	284
	I/O Instruction Restart	285
10.4	Leaving SMM	286
11	128-Bit, 64-Bit, and x87 Programming	289
11.1	Overview of System-Software Considerations	289
11.2	Determining Media and x87 Feature Support	289
11.3	Enabling 128-Bit Media Instructions	290
11.4	Media and x87 Processor State	291

	128-Bit Media State	291
	64-Bit Media State	292
	x87 State	294
	Saving Media and x87 Processor State	295
12	Task Management	307
12.1	Hardware Multitasking Overview	307
12.2	Task-Management Resources	308
	TSS Selector	310
	TSS Descriptor	310
	Task Register	311
	Legacy Task-State Segment	313
	64-Bit Task State Segment	317
	Task Gate Descriptor (Legacy Mode Only)	320
12.3	Hardware Task-Management in Legacy Mode	320
	Task Memory-Mapping	320
	Switching Tasks	321
	Task Switches Using Task Gates	323
	Nesting Tasks	325
13	Debug and Performance Resources	327
13.1	Software-Debug Resources	327
	Debug Registers	328
13.2	Breakpoints	335
	Setting Breakpoints	335
	Using Breakpoints	337
	Single Stepping	339
	Breakpoint Instruction (INT3)	340
	Control-Transfer Breakpoint Features	340
13.3	Performance Optimization	341
	Performance Counters	342
	Performance Event-Select Registers	343
	Using Performance Counters	346
	Time-Stamp Counter	346
14	Processor Initialization and Long Mode Activation	349
14.1	Reset and Initialization	349
	Built-In Self Test (BIST)	349
	Clock Multiplier Selection	350
	Processor Initialization State	350
	Multiple Processor Initialization	352
	Fetching the First Instruction	352
14.2	Hardware Configuration	353
	Processor Implementation Information	353
	Enabling Internal Caches	353
	Initializing Media and x87 Processor State	353
	Model-Specific Initialization	355
14.3	Initializing Real Mode	356

14.4	Initializing Protected Mode	356
14.5	Initializing Long Mode	357
14.6	Enabling and Activating Long Mode	358
	Activating Long Mode	359
	Consistency Checks	359
	Updating System Descriptor Table References	360
	Relocating Page-Translation Tables	360
14.7	Leaving Long Mode	361
14.8	Long-Mode Initialization Example	361
15	Secure Virtual Machine	367
15.1	The Virtual Machine Monitor	367
15.2	SVM Hardware Overview	367
	Virtualization Support	367
	Guest Mode	367
	External Access Protection	368
	Tagged TLB	368
	Interrupt Support	368
	Restartable Instructions	368
	Security Support	368
15.3	SVM Processor and Platform Extensions	368
15.4	Enabling SVM	369
15.5	VMRUN Instruction	369
	Basic Operation	370
15.6	#VMEXIT	374
15.7	Intercept Operation	375
	State Saved on Exit	375
	Intercepts During IDT Interrupt Delivery	376
	EXITINTINFO Pseudo-Code	377
15.8	Instruction Intercepts	378
15.9	IOIO Intercepts	380
15.10	MSR Intercepts	382
15.11	Exception Intercepts	383
	Vector 2 (Reserved)	384
	#BP (Breakpoint)	384
	#OF (Overflow)	384
	#BR (Bound-Range)	384
	#UD (Invalid Opcode)	384
	#NM (Device-Not-Available)	384
	#DF (Double Fault)	384
	Vector 9 (Reserved)	384
	#TS (Invalid TSS)	384
	#NP (Segment Not Present)	385
	#SS (Stack Fault)	385
	#GP (General Protection)	385
	#PF (Page Fault)	385
	#MF (X87 Floating Point)	385
	#AC (Alignment Check)	385

	#MC (Machine Check)	385
	#XF (SIMD Floating Point).	385
15.12	Interrupt Intercepts.	386
	INTR Intercept.	386
	NMI Intercept	386
	SMI Intercept.	386
	INIT Intercept	387
	Virtual Interrupt Intercept	387
15.13	Miscellaneous Intercepts	388
	Task Switch Intercept.	388
	Ferr_Freeze Intercept.	388
	Shutdown Intercept	388
15.14	VMSAVE and VMLOAD Instructions	388
15.15	TLB Control.	389
	TLB Flush	390
	Invalidate Page, Alternate ASID	390
15.16	Global Interrupt Flag, STGI and CLGI Instructions	390
15.17	VMMCALL Instruction.	391
15.18	Paged Real Mode.	391
15.19	Event Injection.	391
15.20	Interrupt and Local APIC Support.	393
	Physical (INTR) Interrupt Masking in EFLAGS.	393
	Virtualizing APIC.TPR	393
	TPR Access in 32-Bit Mode	393
	Injecting Virtual (INTR) Interrupts	394
	Interrupt Shadows	395
	Virtual Interrupt Intercept	395
	Interrupt Masking in Local APIC	395
	INIT Support	395
	NMI Support	396
15.21	SMM Support	396
	Sources of SMI	396
	Response to SMI	397
	Containerizing Platform SMM	397
15.22	Last Branch Record Virtualization	398
	Enabling LBR Virtualization	399
	Host and Guest LBR Virtualization.	399
	LBR Virtualization CPUID Feature Detection	399
15.23	External Access Protection	399
	Device IDs and Protection Domains	400
	Device Exclusion Vector (DEV)	400
	Access Checking	401
	DEV Capability Block.	402
	DEV Register Access Mechanism.	403
	DEV Control and Status Registers.	404
	Unauthorized Access Logging.	406
	Secure Initialization Support	406

15.24	Nested Paging	406
	Traditional Paging versus Nested Paging	406
	Replicated State	408
	Enabling Nested Paging	409
	Nested Paging and VMRUN/#VMEXIT	409
	Nested Table Walk	409
	Nested versus Guest Page Faults, Fault Ordering	410
	Combining Nested and Guest Attributes	411
	Combining Memory Types, MTRRs	411
	Page Splintering	413
	Legacy PAE Mode	413
	A20 Masking	413
	Detecting Nested Paging Support	413
15.25	Security	414
15.26	Secure Startup with SKINIT	414
	Secure Loader	414
	Secure Loader Image	414
	Secure Loader Block	415
	Trusted Platform Module	416
	System Interface, Memory Controller and I/O Hub Logic	417
	SKINIT Operation	417
	SL Abort	418
	Secure Multiprocessor Initialization	418
15.27	Security Exception (#SX)	419
15.28	SVM Related MSRs	420
	VM_CR MSR (C001_0114h)	420
	IGNNE MSR (C001_0115h)	421
	SMM_CTL MSR (C001_0116h)	421
	VM_HSAVE_PA MSR (C001_0117h)	422
15.29	SVM-Lock	422
	SVM_KEY MSR (C001_0118h)	422
15.30	SMM-Lock	422
	SmmLock Bit — HWCR[0]	423
	SMM_KEY MSR (C001_0119h)	423
16	Advanced Programmable Interrupt Controller (APIC)	425
16.1	Sources of Interrupts to the Local APIC	426
16.2	Interrupt Control	427
16.3	Local APIC	427
	Local APIC Enable	427
	APIC Registers	428
	Local APIC ID	430
	APIC Version Register	430
	Extended APIC Control Register	431
16.4	Local Interrupts	431
	APIC Timer Interrupt	433
	Local Interrupts LINT0 and LINT1	435
	Performance Monitor Counter Interrupts	435

	Thermal Sensor Interrupts	436
	Extended Interrupts	436
	APIC Error Interrupts	436
	Spurious Interrupts	438
16.5	Interprocessor Interrupts (IPI)	438
16.6	Local APIC Handling of Interrupts	442
	Receiving System and IPI Interrupts	442
	Lowest Priority Messages and Arbitration	443
	Accepting System and IPI Interrupts	444
	Selecting and Handling Interrupts	447
16.7	SVM Support for Interrupts and the Local APIC	449
	Extended APIC Feature Register	449
	Specific End of Interrupt Register	450
	Interrupt Enable Register	450
17	OS-Visible Workaround Information	453
17.1	Erratum Process Overview	455
18	Hardware P-State Control	457
Appendix A	MSR Cross-Reference	459
A.1	MSR Cross-Reference by MSR Address	459
A.2	System-Software MSR	463
A.3	Memory-Typing MSRs	464
A.4	Machine-Check MSRs	466
A.5	Software-Debug MSRs	467
A.6	Performance-Monitoring MSRs	468
A.7	Secure Virtual Machine MSRs	468
A.8	System Management Mode MSRs	469
A.9	CPUID Name MSR Cross-Reference	469
Appendix B	Layout of VMCB	471
B.1	Layout of VMCB	471
Appendix C	SVM Intercept Exit Codes	477
Index	479

Figures

Figure 1-1.	Segmented-Memory Model	6
Figure 1-2.	Flat Memory Model	7
Figure 1-3.	Paged Memory Model.	8
Figure 1-4.	64-Bit Flat, Paged-Memory Model.	9
Figure 1-5.	Real-Address Memory Model.	10
Figure 1-6.	Operating Modes of the AMD64 Architecture	12
Figure 1-7.	System Registers.	16
Figure 1-8.	System-Data Structures.	18
Figure 3-1.	Control Register 0 (CR0)	43
Figure 3-2.	Control Register 2 (CR2)—Legacy-Mode	46
Figure 3-3.	Control Register 2 (CR2)—Long Mode	46
Figure 3-4.	Control Register 3 (CR3)—Legacy-Mode Non-PAE Paging.	46
Figure 3-5.	Control Register 3 (CR3)—Legacy-Mode PAE Paging.	46
Figure 3-6.	Control Register 3 (CR3)—Long Mode	46
Figure 3-7.	Control Register 4 (CR4)	47
Figure 3-8.	RFLAGS Register.	51
Figure 3-9.	Extended Feature Enable Register (EFER).	55
Figure 3-10.	AMD64 Architecture Model-Specific Registers.	57
Figure 3-11.	System-Configuration Register (SYSCFG)	58
Figure 4-1.	Segmentation Data Structures.	66
Figure 4-2.	Segment and Descriptor-Table Registers	67
Figure 4-3.	Segment Selector.	67
Figure 4-4.	Segment-Register Format	69
Figure 4-5.	FS and GS Segment-Register Format—64-Bit Mode.	70
Figure 4-6.	Global and Local Descriptor-Table Access	72
Figure 4-7.	GDTR and IDTR Format—Legacy Modes	72
Figure 4-8.	GDTR and IDTR Format—Long Mode	73
Figure 4-9.	Relationship between the LDT and GDT	74
Figure 4-10.	LDTR Format—Legacy Mode	75
Figure 4-11.	LDTR Format—Long Mode.	75
Figure 4-12.	Indexing an IDT	77

Figure 4-13. Generic Segment Descriptor—Legacy Mode	78
Figure 4-14. Code-Segment Descriptor—Legacy Mode	80
Figure 4-15. Data-Segment Descriptor—Legacy Mode	81
Figure 4-16. LDT and TSS Descriptor—Legacy/Compatibility Modes	84
Figure 4-17. Call-Gate Descriptor—Legacy Mode	85
Figure 4-18. Interrupt-Gate and Trap-Gate Descriptors—Legacy Mode	85
Figure 4-19. Task-Gate Descriptor—Legacy Mode	85
Figure 4-20. Code-Segment Descriptor—Long Mode	86
Figure 4-21. Data-Segment Descriptor—Long Mode	87
Figure 4-22. System-Segment Descriptor—64-Bit Mode	89
Figure 4-23. Call-Gate Descriptor—Long Mode	90
Figure 4-24. Interrupt-Gate and Trap-Gate Descriptors—Long Mode	91
Figure 4-25. Privilege-Level Relationships	94
Figure 4-26. Data-Access Privilege-Check Examples	96
Figure 4-27. Stack-Access Privilege-Check Examples	97
Figure 4-28. Nonconforming Code-Segment Privilege-Check Examples	100
Figure 4-29. Conforming Code-Segment Privilege-Check Examples	101
Figure 4-30. Legacy-Mode Call-Gate Transfer Mechanism	102
Figure 4-31. Long-Mode Call-Gate Access Mechanism	103
Figure 4-32. Privilege-Check Examples for Call Gates	105
Figure 4-33. Legacy-Mode 32-Bit Stack Switch, with Parameters	107
Figure 4-34. 32-Bit Stack Switch, No Parameters—Legacy Mode	107
Figure 4-35. Stack Switch—Long Mode	108
Figure 5-1. Virtual to Physical Address Translation—Long Mode	117
Figure 5-2. Control Register 3 (CR3)—Non-PAE Paging Legacy-Mode	121
Figure 5-3. Control Register 3 (CR3)—PAE Paging Legacy-Mode	121
Figure 5-4. 4-Kbyte Non-PAE Page Translation—Legacy Mode	122
Figure 5-5. 4-Kbyte PDE—Non-PAE Paging Legacy-Mode	123
Figure 5-6. 4-Kbyte PTE—Non-PAE Paging Legacy-Mode	123
Figure 5-7. 4-Mbyte Page Translation—Non-PAE Paging Legacy-Mode	124
Figure 5-8. 4-Mbyte PDE—Non-PAE Paging Legacy-Mode	124
Figure 5-9. 4-Kbyte PAE Page Translation—Legacy Mode	125
Figure 5-10. 4-Kbyte PDPE—PAE Paging Legacy-Mode	126

Figure 5-11.	4-Kbyte PDE—PAE Paging Legacy-Mode	126
Figure 5-12.	4-Kbyte PTE—PAE Paging Legacy-Mode	126
Figure 5-13.	2-Mbyte PAE Page Translation—Legacy Mode	127
Figure 5-14.	2-Mbyte PDPE—PAE Paging Legacy-Mode	127
Figure 5-15.	2-Mbyte PDE—PAE Paging Legacy-Mode	128
Figure 5-16.	Control Register 3 (CR3)—Long Mode	129
Figure 5-17.	4-Kbyte Page Translation—Long Mode	130
Figure 5-18.	4-Kbyte PML4E—Long Mode	131
Figure 5-19.	4-Kbyte PDPE—Long Mode	131
Figure 5-20.	4-Kbyte PDE—Long Mode	131
Figure 5-21.	4-Kbyte PTE—Long Mode	131
Figure 5-22.	2-Mbyte Page Translation—Long Mode	132
Figure 5-23.	2-Mbyte PML4E—Long Mode	133
Figure 5-24.	2-Mbyte PDPE—Long Mode	133
Figure 5-25.	2-Mbyte PDE—Long Mode	133
Figure 5-26.	1-Gbyte Page Translation—Long Mode	134
Figure 5-27.	1-Gbyte PML4E—Long Mode	135
Figure 5-28.	1-Gbyte PDPE—Long Mode	135
Figure 6-1.	STAR, LSTAR, CSTAR, and MASK MSRs	151
Figure 6-2.	SYSENTER_CS, SYSENTER_ESP, SYSENTER_EIP MSRs	152
Figure 7-1.	Processor and Memory System	160
Figure 7-2.	MOESI State Transitions	168
Figure 7-3.	Cache Organization Example	177
Figure 7-4.	MTRR Mapping of Physical Memory	185
Figure 7-5.	Fixed-Range MTRR	186
Figure 7-6.	MTRRphysBasen Register	187
Figure 7-7.	MTRRphysMaskn Register	188
Figure 7-8.	MTRR defType Register Format	189
Figure 7-9.	MTRR Capability Register Format	190
Figure 7-10.	PAT Register	193
Figure 7-11.	Extended MTRR Type-Field Format (Fixed-Range MTRRs)	198
Figure 7-12.	IORRBasen Register	200
Figure 7-13.	IORRMaskn Register	201

Figure 7-14. Memory Organization Using Top-of-Memory Registers	202
Figure 7-15. Top-of-Memory Registers (TOP_MEM, TOP_MEM2).	202
Figure 8-1. Control Register 2 (CR2)	220
Figure 8-2. Selector Error Code.	225
Figure 8-3. Page-Fault Error Code	225
Figure 8-4. Task Priority Register (CR8)	229
Figure 8-5. Real-Mode Interrupt Control Transfer	230
Figure 8-6. Stack After Interrupt in Real Mode.	231
Figure 8-7. Protected-Mode Interrupt Control Transfer	233
Figure 8-8. Stack After Interrupt to Same Privilege Level	234
Figure 8-9. Stack After Interrupt to Higher Privilege	235
Figure 8-10. Privilege-Check Examples for Interrupts	237
Figure 8-11. Stack After Virtual-8086 Mode Interrupt to Protected Mode.	240
Figure 8-12. Long-Mode Interrupt Control Transfer.	242
Figure 8-13. Long-Mode Stack After Interrupt—Same Privilege.	244
Figure 8-14. Long-Mode Stack After Interrupt—Higher Privilege.	245
Figure 8-15. Long-Mode IST Mechanism.	246
Figure 9-1. MCG_CAP Register	257
Figure 9-2. MCG_STATUS Register	258
Figure 9-3. MCG_CTL Register	259
Figure 9-4. CPU Watchdog Timer Register Format	259
Figure 9-5. MCI_CTL Registers	261
Figure 9-6. MCI_STATUS Register	262
Figure 9-7. MCI_MISC1 Addressing	265
Figure 9-8. Machine Check Miscellaneous Error-Information Register (MCI_MISCj).	265
Figure 10-1. Default SMRAM Memory Map	273
Figure 10-2. SMBASE Register	273
Figure 10-3. SMM-Revision Identifier	279
Figure 10-4. SSM_ADDR Register Format	280
Figure 10-5. SSM_MASK Register Format	280
Figure 10-6. I/O Instruction Restart Dword.	286
Figure 11-1. 128-Bit Media-Instruction State	292
Figure 11-2. 64-Bit Media-Instruction State	293

Figure 11-3. x87-Instruction State	295
Figure 11-4. FSAVE/FNSAVE Image (32-Bit, Protected Mode)	297
Figure 11-5. FSAVE/FNSAVE Image (32-Bit, Real/Virtual-8086 Modes)	298
Figure 11-6. FSAVE/FNSAVE Image (16-Bit, Protected Mode)	299
Figure 11-7. FSAVE/FNSAVE Image (16-Bit, Real/Virtual-8086 Modes)	300
Figure 11-8. FXSAVE and FXRSTOR Image (64-bit Mode)	302
Figure 11-9. FXSAVE and FXRSTOR Image (Non-64-bit Mode)	303
Figure 12-1. Task-Management Resources	309
Figure 12-2. Task-Segment Selector	310
Figure 12-3. TR Format, Legacy Mode	311
Figure 12-4. TR Format, Long Mode	312
Figure 12-5. Relationship between the TSS and GDT	312
Figure 12-6. Legacy 32-bit TSS	314
Figure 12-7. I/O-Permission Bitmap Example	317
Figure 12-8. Long Mode TSS Format	319
Figure 12-9. Task-Gate Descriptor, Legacy Mode Only	320
Figure 12-10. Privilege-Check Examples for Task Gates	324
Figure 13-1. Address-Breakpoint Registers (DR0–DR3)	329
Figure 13-2. Debug-Status Register (DR6)	330
Figure 13-3. Debug-Control Register (DR7)	331
Figure 13-4. Debug-Control MSR (DebugCtlMSR)	334
Figure 13-5. Control-Transfer Recording MSRs	335
Figure 13-6. Performance Counter (PerfCtrn)	342
Figure 13-7. Performance Event-Select Register (PerfEvtSel n)	344
Figure 13-8. Time-Stamp Counter (TSC)	346
Figure 15-1. EXITINTINFO for All Intercepts	376
Figure 15-2. EXITINFO1 for IOIO Intercept	381
Figure 15-3. EXITINFO1 for SMI Intercept	387
Figure 15-4. EVENTINJ Field in the VMCB	392
Figure 15-5. Host Bridge DMA Checking	402
Figure 15-6. Format of DEV_OP Register (in PCI Config Space)	403
Figure 15-7. Format of DEV_CAP Register (in PCI Config Space)	404
Figure 15-8. Format of DEV_BASE_HI $[n]$ Registers	405

Figure 15-9. Format of DEV_BASE_LO[n] Registers	405
Figure 15-10. Format of DEV_MAP[n] Registers	405
Figure 15-11. Address Translation with Traditional Paging	407
Figure 15-12. Address Translation with Nested Paging	408
Figure 15-13. SLB Example Layout	416
Figure 15-14. Layout of VM_CR MSR (C001_0114h)	420
Figure 15-15. Layout of SMM_CTL MSR (C001_0116h)	421
Figure 16-1. Block Diagram of a Typical APIC Implementation	425
Figure 16-2. APIC Base Address Register	428
Figure 16-3. APIC ID Register (APIC Offset 20h)	430
Figure 16-4. APIC Version Register (APIC Offset 30h)	430
Figure 16-5. Extended APIC Control Register (APIC Offset 410h)	431
Figure 16-6. General Local Vector Table Register Format	432
Figure 16-7. APIC Timer Local Vector Table Register (APIC Offset 320h)	433
Figure 16-8. Timer Current Count Register (APIC Offset 390h)	434
Figure 16-9. Timer Initial Count Register (APIC Offset 380h)	434
Figure 16-10. Divide Configuration Register (APIC Offset 3E0h)	434
Figure 16-11. Local Interrupt 0/1 (LINT0/1) Local Vector Table Register (APIC Offset 350h/360h)	435
Figure 16-12. Performance Monitor Counter Local Vector Table Register (APIC Offset 340h)	436
Figure 16-13. Thermal Sensor Local Vector Table Register (APIC Offset 330h)	436
Figure 16-14. APIC Error Local Vector Table Register (APIC Offset 370h)	437
Figure 16-15. APIC Error Status Register (APIC Offset 280h)	437
Figure 16-16. Spurious Interrupt Register (APIC Offset F0h)	438
Figure 16-17. Interrupt Command Register (APIC Offset 310:300h)	439
Figure 16-18. Remote Read Register (APIC Offset C0h)	441
Figure 16-19. Logical Destination Register (APIC Offset D0h)	442
Figure 16-20. Destination Format Register (APIC Offset E0h)	442
Figure 16-21. Arbitration Priority Register (APIC Offset 90h)	443
Figure 16-22. Interrupt Request Register (APIC Offset 270:200h)	445
Figure 16-23. In Service Register (APIC Offset 170:100h)	445
Figure 16-24. Trigger Mode Register (APIC Offset 1F0:180h)	446
Figure 16-25. Task Priority Register (APIC Offset 80h)	447
Figure 16-26. Processor Priority Register (APIC Offset A0h)	448

Figure 16-27. End of Interrupt (APIC Offset B0h)	449
Figure 16-28. Extended APIC Feature Register (APIC Offset 400h)	449
Figure 16-29. Specific End of Interrupt (APIC Offset 420h)	450
Figure 16-30. Interrupt Enable Register (APIC Offset 4F0:480h)	450
Figure 17-1. OSVW MSR0: OSVW_ID_Length	453
Figure 17-2. OSVW MSR1: OSVW Status.	454
Figure 17-3. OSVW MSRn: OSVW Status.	454
Figure 18-1. P-State Current Limit Register	457
Figure 18-2. P-State Control Register	458
Figure 18-3. P-State Status Register	458

Tables

Table 1-1.	Operating Modes	11
Table 1-2.	Interrupts and Exceptions	20
Table 2-1.	Instructions That Reference RSP	31
Table 2-2.	64-Bit Mode Near Branches, Default 64-Bit Operand Size	32
Table 2-3.	Invalid Instructions in 64-Bit Mode	34
Table 2-4.	Invalid Instructions in Long Mode	35
Table 2-5.	Reassigned Instructions in 64-Bit Mode	36
Table 2-6.	Differences Between Long Mode and Legacy Mode	39
Table 4-1.	Segment Registers	69
Table 4-2.	Descriptor Types	79
Table 4-3.	Code-Segment Descriptor Types	81
Table 4-4.	Data-Segment Descriptor Types	82
Table 4-5.	System-Segment Descriptor Types (S=0)—Legacy Mode	83
Table 4-6.	System-Segment Descriptor Types—Long Mode	88
Table 4-7.	Descriptor-Entry Field Changes in Long Mode	92
Table 5-1.	Supported Paging Alternatives (CR0.PG=1)	118
Table 5-2.	Physical-Page Protection, CR0.WP=0	144
Table 5-3.	Effect of CR0.WP=1 on Supervisor Page Access	145
Table 6-1.	System Management Instructions	147
Table 7-1.	Memory Access by Memory Type	171
Table 7-2.	Caching Policy by Memory Type	172
Table 7-3.	Memory Access Ordering Rules	173
Table 7-4.	AMD64 Architecture Cache-Operating Modes	179
Table 7-5.	MTRR Type Field Encodings	184
Table 7-6.	Fixed-Range MTRR Address Ranges	186
Table 7-7.	Combined MTRR and Page-Level Memory Type with Unmodified PAT MSR	191
Table 7-8.	PAT Type Encodings	194
Table 7-9.	PAT-Register PA-Field Indexing	195
Table 7-10.	Combined Effect of MTRR and PAT Memory Types	196
Table 7-11.	Extended Fixed-Range MTRR Type Encodings	199
Table 8-1.	Interrupt-Vector Source and Cause	209
Table 8-2.	Interrupt-Vector Classification	210
Table 8-3.	Double-Fault Exception Conditions	215
Table 8-4.	Invalid-TSS Exception Conditions	216

Table 8-5.	Stack Exception Error Codes	218
Table 8-6.	General-Protection Exception Conditions	219
Table 8-7.	Data-Type Alignment	222
Table 8-8.	Simultaneous Interrupt Priorities	226
Table 8-9.	Simultaneous Floating-Point Exception Priorities	228
Table 8-10.	Virtual-8086 Mode Interrupt Mechanisms	239
Table 8-11.	Effect of Instructions that Modify the IF Bit	252
Table 9-1.	CPU Watchdog Timer Time Base	260
Table 9-2.	CPU Watchdog Timer Count Select	260
Table 10-1.	AMD64 Architecture SMM State-Save Area	274
Table 10-2.	Legacy SMM State-Save Area (Not used by AMD64 Architecture)	277
Table 10-3.	SMM Register Initialization	281
Table 11-1.	Deriving FSAVE Tag Field from FXSAVE Tag Field	306
Table 12-1.	Effects of Task Nesting	325
Table 13-1.	Breakpoint-Setting Examples	336
Table 13-2.	Breakpoint Location by Condition	337
Table 13-3.	Operating-System Mode and User Mode Bits	345
Table 14-1.	Initial Processor State	350
Table 14-2.	Initial State of Segment-Register Attributes	352
Table 14-3.	x87 Floating-Point State Initialization	354
Table 14-4.	Processor Operating Modes	358
Table 14-5.	Long-Mode Consistency Checks	360
Table 15-1.	Guest Exception or Interrupt Types	376
Table 15-2.	Instruction Intercepts	378
Table 15-3.	Ranges of MSR Permissions Map	382
Table 15-4.	Effect of the GIF on Interrupt Handling	390
Table 15-5.	Guest Exception or Interrupt Types	392
Table 15-6.	INIT Handling in Different Operating Modes	396
Table 15-7.	NMI Handling in Different Operating Modes	396
Table 15-8.	SMI Handling in Different Operating Modes	397
Table 15-9.	DEV Capability Block, Overall Layout	402
Table 15-10.	DEV Capability Header (DEV_HDR) (in PCI Config Space)	403
Table 15-11.	Encoding of Function Field in DEV_OP Register	403
Table 15-12.	DEV_CR Control Register	404
Table 15-13.	Combining Guest and Host PAT Types	412
Table 15-14.	Combining PAT and MTRR Types	413

Table 16-1.	Interrupt Sources for Local APIC	426
Table 16-2.	APIC Registers	429
Table 16-3.	Divide Values	435
Table 16-4.	Valid ICR Field Combinations	441
Table A-1.	MSRs of the AMD64 Architecture	459
Table A-2.	System-Software MSR Cross-Reference	463
Table A-3.	Memory-Typing MSR Cross-Reference	464
Table A-4.	Machine-Check MSR Cross-Reference	466
Table A-5.	Software-Debug MSR Cross-Reference	467
Table A-6.	Performance-Monitoring MSR Cross-Reference	468
Table A-7.	Secure Virtual Machine MSR Cross-Reference	468
Table A-8.	System Management Mode MSR Cross-Reference	469
Table A-9.	CPUID Namestring MSRs	469
Table B-1.	VMCB Layout, Control Area	471
Table B-2.	VMCB Layout, State Save Area	474
Table C-1.	SVM Intercept Codes	477

Revision History

Date	Revision	Description
September 2007	3.14	<p>Added information on "Speculative Caching of Address Translations," "Caching of Upper Level Translation Table Entries," "Use of Cached Entries When Reporting a Page Fault Exception," "Use of Cached Entries When Reporting a Page Fault Exception," "Handling of D-Bit Updates," "Invalidation of Cached Upper-level Entries by INVLPG" and "Handling of PDPT Entries in PAE Mode" to section 5.5.2, "TLB Management" on page 140.</p> <p>Added 15.20.7, "Interrupt Masking in Local APIC" on page 395.</p> <p>Added 16.3.5, "Extended APIC Control Register" on page 431; clarified the use of the ICR DS bit in 16.5, "Interprocessor Interrupts (IPI)" on page 438.</p> <p>Added minor clarifications and corrected typographical and formatting errors.</p>
July 2007	3.13	<p>Added 5.3.5, "1-Gbyte Page Translation" on page 133.</p> <p>Added 7.2, "Multiprocessor Memory Access Ordering" on page 164</p> <p>Added divide-by-zero exception to Table 8-8, "Simultaneous Interrupt Priorities", on page 226.</p> <p>Added information on "CPU Watchdog Timer Register" and "Machine-Check Miscellaneous-Error Information Registers (MCI_MISCj)" to Chapter 9.</p> <p>Added SSE4A support to Chapter 11, "128-Bit, 64-Bit, and x87 Programming" on page 289.</p> <p>Added Monitor and MWAIT intercept information to section 15.8, "Instruction Intercepts" on page 378 and reorganized intercept information; clarified 15.15.1, "TLB Flush" on page 390.</p> <p>Added Monitor and MWAIT intercepts to tables B-1, "VMCB Layout, Control Area" on page 471 and C-1, "SVM Intercept Codes" on page 477.</p> <p>Added Chapter 16, "Advanced Programmable Interrupt Controller (APIC)" on page 425, Chapter 17, "OS-Visible Workaround Information" on page 453, Chapter 18, "Hardware P-State Control" on page 457.</p> <p>Added Table A-7, "Secure Virtual Machine MSR Cross-Reference", on page 468.</p> <p>Added minor clarifications and corrected typographical and formatting errors.</p>
September 2006	3.12	Added numerous minor clarifications.
December 2005	3.11	Added Chapter 15, Secure Virtual Machine. Incorporated numerous factual corrections and updates.
February 2005	3.10	Corrected Table 8-6, "General-Protection Exception Conditions", on page 219. Added SSE3 information. Clarified and corrected information on the CPUID instruction and feature identification. Added information on the RDTSCP instruction. Clarified information about MTRRs and PATs in multiprocessing systems.

Date	Revision	Description
September 2003	3.09	Corrected numerous minor typographical errors.
April 2003	3.08	Clarified terms in section on FXSAVE/FXSTOR. Corrected several minor errors of omission. Documentation of CR0.NW bit has been corrected. Several register diagrams and figure labels have been corrected. Description of shared cache lines has been clarified in 7.3, "Memory Coherency and Protocol" on page 167.
September 2002	3.07	Made numerous small grammatical changes and factual clarifications. Added Revision History.

Preface

About This Book

This book is part of a multivolume work entitled the *AMD64 Architecture Programmer's Manual*. This table lists each volume and its order number.

Title	Order No.
<i>Volume 1: Application Programming</i>	24592
<i>Volume 2: System Programming</i>	24593
<i>Volume 3: General-Purpose and System Instructions</i>	24594
<i>Volume 4: 128-Bit Media Instructions</i>	26568
<i>Volume 5: 64-Bit Media and x87 Floating-Point Instructions</i>	26569

Audience

This volume (Volume 2) is intended for programmers writing operating systems, loaders, linkers, device drivers, or system utilities. It assumes an understanding of AMD64 architecture application-level programming as described in Volume 1.

This volume describes the AMD64 architecture's resources and functions that are managed by system software, including operating-mode control, memory management, interrupts and exceptions, task and state-change management, system-management mode (including power management), multi-processor support, debugging, and processor initialization.

Application-programming topics are described in Volume 1. Details about each instruction are described in volumes 3, 4, and 5.

Organization

This volume begins with an overview of system programming and differences between the x86 and AMD64 architectures. This is followed by chapters that describe the following details of system programming:

- *System Resources*—The system registers and processor ID (CPUID) functions.
- *Segmented Virtual Memory*—The segmented-memory models supported by the architecture and their associated data structures and protection checks.
- *Page Translation and Protection*—The page-translation functions supported by the architecture and their associated data structures and protection checks.

- *System-Management Instructions*—The instructions used to manage system functions.
- *Memory System*—The memory-system hierarchy and its resources and protocols, including memory-characterization, caching, and buffering functions.
- *Exceptions and Interrupts*—Details about the types and causes of exceptions and interrupts, and the methods of transferring control during these events.
- *Machine-Check Mechanism*—The resources and functions that support detection and handling of machine-check errors.
- *System-Management Mode*—The resources and functions that support system-management mode (SMM), including power-management functions.
- *128-Bit, 64-Bit, and x87 Programming*—The resources and functions that support use (by application software) and state-saving (by the operation system) of the 128-bit media, 64-bit media, and x87 floating-point instructions.
- *Multiple-Processor Management*—The features of the instruction set and the system resources and functions that support multiprocessing environments.
- *Debug and Performance Resources*—The system resources and functions that support software debugging and performance monitoring.
- *Legacy Task Management*—Support for the legacy hardware multitasking functions, including register resources and data structures.
- *Processor Initialization and Long-Mode Activation*—The methods by which system software initializes and changes operating modes.
- *Mixing Code Across Operating Modes*—Things to remember when running programs in different operating modes.
- *Secure Virtual Machine*—The system resources that support virtualization development and deployment.

There are appendices describing details of model-specific registers (MSRs) and machine-check implementations. Definitions assumed throughout this volume are listed below. The index at the end of this volume cross-references topics within the volume. For other topics relating to the AMD64 architecture, see the tables of contents and indexes of the other volumes.

Definitions

Some of the following definitions assume a knowledge of the legacy x86 architecture. See “Related Documents” on page xxxix for descriptions of the legacy x86 architecture.

Terms and Notation

1011b

A binary value—in this example, a 4-bit value.

F0EAh

A hexadecimal value—in this example a 2-byte value.

[1,2)

A range that includes the left-most value (in this case, 1) but excludes the right-most value (in this case, 2).

7–4

A bit range, from bit 7 to 4, inclusive. The high-order bit is shown first.

128-bit media instructions

Instructions that use the 128-bit XMM registers. These are a combination of the SSE and SSE2 instruction sets.

64-bit media instructions

Instructions that use the 64-bit MMX registers. These are primarily a combination of MMX and 3DNow!™ instruction sets, with some additional instructions from the SSE and SSE2 instruction sets.

16-bit mode

Legacy mode or compatibility mode in which a 16-bit address size is active. See *legacy mode* and *compatibility mode*.

32-bit mode

Legacy mode or compatibility mode in which a 32-bit address size is active. See *legacy mode* and *compatibility mode*.

64-bit mode

A submode of *long mode*. In 64-bit mode, the default address size is 64 bits and new features, such as register extensions, are supported for system and application software.

#GP(0)

Notation indicating a general-protection exception (#GP) with error code of 0.

absolute

Said of a displacement that references the base of a code segment rather than an instruction pointer. Contrast with *relative*.

ASID

Address space identifier.

biased exponent

The sum of a floating-point value's exponent and a constant bias for a particular floating-point data type. The bias makes the range of the biased exponent always positive, which allows reciprocation without overflow.

byte

Eight bits.

clear

To write a bit value of 0. Compare *set*.

compatibility mode

A submode of *long mode*. In compatibility mode, the default address size is 32 bits, and legacy 16-bit and 32-bit applications run without modification.

commit

To irreversibly write, in program order, an instruction's result to software-visible storage, such as a register (including flags), the data cache, an internal write buffer, or memory.

CPL

Current privilege level.

CR0–CR4

A register range, from register CR0 through CR4, inclusive, with the low-order register first.

CR0.PE = 1

Notation indicating that the PE bit of the CR0 register has a value of 1.

direct

Referencing a memory location whose address is included in the instruction's syntax as an immediate operand. The address may be an absolute or relative address. Compare *indirect*.

dirty data

Data held in the processor's caches or internal buffers that is more recent than the copy held in main memory.

displacement

A signed value that is added to the base of a segment (absolute addressing) or an instruction pointer (relative addressing). Same as *offset*.

doubleword

Two words, or four bytes, or 32 bits.

double quadword

Eight words, or 16 bytes, or 128 bits. Also called *octword*.

DS:rSI

The contents of a memory location whose segment address is in the DS register and whose offset relative to that segment is in the rSI register.

EFER.LME = 0

Notation indicating that the LME bit of the EFER register has a value of 0.

effective address size

The address size for the current instruction after accounting for the default address size and any address-size override prefix.

effective operand size

The operand size for the current instruction after accounting for the default operand size and any operand-size override prefix.

element

See *vector*.

exception

An abnormal condition that occurs as the result of executing an instruction. The processor's response to an exception depends on the type of the exception. For all exceptions except 128-bit media SIMD floating-point exceptions and x87 floating-point exceptions, control is transferred to the handler (or service routine) for that exception, as defined by the exception's vector. For floating-point exceptions defined by the IEEE 754 standard, there are both masked and unmasked responses. When unmasked, the exception handler is called, and when masked, a default response is provided instead of calling the handler.

FF /0

Notation indicating that FF is the first byte of an opcode, and a subopcode in the ModR/M byte has a value of 0.

flush

An often ambiguous term meaning (1) writeback, if modified, and invalidate, as in “flush the cache line,” or (2) invalidate, as in “flush the pipeline,” or (3) change a value, as in “flush to zero.”

GDT

Global descriptor table.

GIF

Global interrupt flag.

IDT

Interrupt descriptor table.

IGN

Ignore. Field is ignored.

indirect

Referencing a memory location whose address is in a register or other memory location. The address may be an absolute or relative address. Compare *direct*.

IRB

The virtual-8086 mode interrupt-redirection bitmap.

IST

The long-mode interrupt-stack table.

IVT

The real-address mode interrupt-vector table.

LDT

Local descriptor table.

legacy x86

The legacy x86 architecture. See “Related Documents” on page xxxix for descriptions of the legacy x86 architecture.

legacy mode

An operating mode of the AMD64 architecture in which existing 16-bit and 32-bit applications and operating systems run without modification. A processor implementation of the AMD64 architecture can run in either *long mode* or *legacy mode*. Legacy mode has three submodes, *real mode*, *protected mode*, and *virtual-8086 mode*.

long mode

An operating mode unique to the AMD64 architecture. A processor implementation of the AMD64 architecture can run in either *long mode* or *legacy mode*. Long mode has two submodes, *64-bit mode* and *compatibility mode*.

lsb

Least-significant bit.

LSB

Least-significant byte.

main memory

Physical memory, such as RAM and ROM (but not cache memory) that is installed in a particular computer system.

mask

(1) A control bit that prevents the occurrence of a floating-point exception from invoking an exception-handling routine. (2) A field of bits used for a control purpose.

MBZ

Must be zero. If software attempts to set an MBZ bit to 1, a general-protection exception (#GP) occurs.

memory

Unless otherwise specified, *main memory*.

ModRM

A byte following an instruction opcode that specifies address calculation based on mode (Mod), register (R), and memory (M) variables.

moffset

A 16, 32, or 64-bit offset that specifies a memory operand directly, without using a ModRM or SIB byte.

msb

Most-significant bit.

MSB

Most-significant byte.

multimedia instructions

A combination of *128-bit media instructions* and *64-bit media instructions*.

octword

Same as *double quadword*.

offset

Same as *displacement*.

overflow

The condition in which a floating-point number is larger in magnitude than the largest, finite, positive or negative number that can be represented in the data-type format being used.

packed

See *vector*.

PAE

Physical-address extensions.

physical memory

Actual memory, consisting of *main memory* and cache.

probe

A check for an address in a processor's caches or internal buffers. *External probes* originate outside the processor, and *internal probes* originate within the processor.

protected mode

A submode of *legacy mode*.

quadword

Four words, or eight bytes, or 64 bits.

RAZ

Read as zero (0), regardless of what is written.

real-address mode

See *real mode*.

real mode

A short name for *real-address mode*, a submode of *legacy mode*.

relative

Referencing with a displacement (also called offset) from an instruction pointer rather than the base of a code segment. Contrast with *absolute*.

reserved

Fields marked as reserved may be used at some future time.

To preserve compatibility with future processors, reserved fields require special handling when read or written by software.

Reserved fields may be further qualified as MBZ, RAZ, SBZ or IGN (see definitions).

Software must not depend on the state of a reserved field, nor upon the ability of such fields to return to a previously written state.

If a reserved field is not marked with one of the above qualifiers, software must not change the state of that field; it must reload that field with the same values returned from a prior read.

REX

An instruction prefix that specifies a 64-bit operand size and provides access to additional registers.

RIP-relative addressing

Addressing relative to the 64-bit RIP instruction pointer.

SBZ

Should be zero. An attempt by software to set an SBZ bit to 1 results in undefined behavior.

set

To write a bit value of 1. Compare *clear*.

SIB

A byte following an instruction opcode that specifies address calculation based on scale (S), index (I), and base (B).

SIMD

Single instruction, multiple data. See *vector*.

SSE

Streaming SIMD extensions instruction set. See *128-bit media instructions* and *64-bit media instructions*.

SSE2

Extensions to the SSE instruction set. See *128-bit media instructions* and *64-bit media instructions*.

SSE3

Further extensions to the SSE instruction set. See *128-bit media instructions*.

sticky bit

A bit that is set or cleared by hardware and that remains in that state until explicitly changed by software.

TOP

The x87 top-of-stack pointer.

TSS

Task-state segment.

underflow

The condition in which a floating-point number is smaller in magnitude than the smallest nonzero, positive or negative number that can be represented in the data-type format being used.

vector

(1) A set of integer or floating-point values, called *elements*, that are packed into a single operand. Most of the 128-bit and 64-bit media instructions use vectors as operands. Vectors are also called *packed* or *SIMD* (single-instruction multiple-data) operands.

(2) An index into an interrupt descriptor table (IDT), used to access exception handlers. Compare *exception*.

virtual-8086 mode

A submode of *legacy mode*.

VMCB

Virtual machine control block.

VMM

Virtual machine monitor.

word

Two bytes, or 16 bits.

x86

See *legacy x86*.

Registers

In the following list of registers, the names are used to refer either to a given register or to the contents of that register:

AH–DH

The high 8-bit AH, BH, CH, and DH registers. Compare *AL–DL*.

AL–DL

The low 8-bit AL, BL, CL, and DL registers. Compare *AH–DH*.

AL–r15B

The low 8-bit AL, BL, CL, DL, SIL, DIL, BPL, SPL, and R8B–R15B registers, available in 64-bit mode.

BP

Base pointer register.

CR_n

Control register number *n*.

CS

Code segment register.

eAX–eSP

The 16-bit AX, BX, CX, DX, DI, SI, BP, and SP registers or the 32-bit EAX, EBX, ECX, EDX, EDI, ESI, EBP, and ESP registers. Compare *rAX–rSP*.

EFER

Extended features enable register.

eFLAGS

16-bit or 32-bit flags register. Compare *rFLAGS*.

EFLAGS

32-bit (extended) flags register.

eIP

16-bit or 32-bit instruction-pointer register. Compare *rIP*.

EIP

32-bit (extended) instruction-pointer register.

FLAGS

16-bit flags register.

GDTR

Global descriptor table register.

GPRs

General-purpose registers. For the 16-bit data size, these are AX, BX, CX, DX, DI, SI, BP, and SP. For the 32-bit data size, these are EAX, EBX, ECX, EDX, EDI, ESI, EBP, and ESP. For the 64-bit data size, these include RAX, RBX, RCX, RDX, RDI, RSI, RBP, RSP, and R8–R15.

IDTR

Interrupt descriptor table register.

IP

16-bit instruction-pointer register.

LDTR

Local descriptor table register.

MSR

Model-specific register.

r8–r15

The 8-bit R8B–R15B registers, or the 16-bit R8W–R15W registers, or the 32-bit R8D–R15D registers, or the 64-bit R8–R15 registers.

rAX–rSP

The 16-bit AX, BX, CX, DX, DI, SI, BP, and SP registers, or the 32-bit EAX, EBX, ECX, EDX, EDI, ESI, EBP, and ESP registers, or the 64-bit RAX, RBX, RCX, RDX, RDI, RSI, RBP, and RSP registers. Replace the placeholder *r* with nothing for 16-bit size, “E” for 32-bit size, or “R” for 64-bit size.

RAX

64-bit version of the EAX register.

RBP

64-bit version of the EBP register.

RBX

64-bit version of the EBX register.

RCX

64-bit version of the ECX register.

RDI

64-bit version of the EDI register.

RDX

64-bit version of the EDX register.

rFLAGS

16-bit, 32-bit, or 64-bit flags register. Compare *RFLAGS*.

RFLAGS

64-bit flags register. Compare *rFLAGS*.

rIP

16-bit, 32-bit, or 64-bit instruction-pointer register. Compare *RIP*.

RIP

64-bit instruction-pointer register.

RSI

64-bit version of the ESI register.

RSP

64-bit version of the ESP register.

SP

Stack pointer register.

SS

Stack segment register.

TPR

Task priority register (CR8), a new register introduced in the AMD64 architecture to speed interrupt management.

TR

Task register.

Endian Order

The x86 and AMD64 architectures address memory using little-endian byte-ordering. Multibyte values are stored with their least-significant byte at the lowest byte address, and they are illustrated with their least significant byte at the right side. Strings are illustrated in reverse order, because the addresses of their bytes increase from right to left.

Related Documents

- Peter Abel, *IBM PC Assembly Language and Programming*, Prentice-Hall, Englewood Cliffs, NJ, 1995.
- Rakesh Agarwal, *80x86 Architecture & Programming: Volume II*, Prentice-Hall, Englewood Cliffs, NJ, 1991.
- AMD data sheets and application notes for particular hardware implementations of the AMD64 architecture.
- AMD, *AMD-K6™ MMX™ Enhanced Processor Multimedia Technology*, Sunnyvale, CA, 2000.
- AMD, *3DNow!™ Technology Manual*, Sunnyvale, CA, 2000.
- AMD, *AMD Extensions to the 3DNow!™ and MMX™ Instruction Sets*, Sunnyvale, CA, 2000.
- AMD, *SYSCALL and SYSRET Instruction Specification Application Note*, Sunnyvale, CA, 1998.
- Don Anderson and Tom Shanley, *Pentium Processor System Architecture*, Addison-Wesley, New York, 1995.
- Nabajyoti Barkakati and Randall Hyde, *Microsoft Macro Assembler Bible*, Sams, Carmel, Indiana, 1992.
- Barry B. Brey, *8086/8088, 80286, 80386, and 80486 Assembly Language Programming*, Macmillan Publishing Co., New York, 1994.
- Barry B. Brey, *Programming the 80286, 80386, 80486, and Pentium Based Personal Computer*, Prentice-Hall, Englewood Cliffs, NJ, 1995.
- Ralf Brown and Jim Kyle, *PC Interrupts*, Addison-Wesley, New York, 1994.
- Penn Brumm and Don Brumm, *80386/80486 Assembly Language Programming*, Windcrest McGraw-Hill, 1993.
- Geoff Chappell, *DOS Internals*, Addison-Wesley, New York, 1994.
- Chips and Technologies, Inc. *Super386 DX Programmer's Reference Manual*, Chips and Technologies, Inc., San Jose, 1992.
- John Crawford and Patrick Gelsinger, *Programming the 80386*, Sybex, San Francisco, 1987.
- Cyrix Corporation, *5x86 Processor BIOS Writer's Guide*, Cyrix Corporation, Richardson, TX, 1995.

- Cyrix Corporation, *MI Processor Data Book*, Cyrix Corporation, Richardson, TX, 1996.
- Cyrix Corporation, *MX Processor MMX Extension Opcode Table*, Cyrix Corporation, Richardson, TX, 1996.
- Cyrix Corporation, *MX Processor Data Book*, Cyrix Corporation, Richardson, TX, 1997.
- Ray Duncan, *Extending DOS: A Programmer's Guide to Protected-Mode DOS*, Addison Wesley, NY, 1991.
- William B. Giles, *Assembly Language Programming for the Intel 80xxx Family*, Macmillan, New York, 1991.
- Frank van Gilluwe, *The Undocumented PC*, Addison-Wesley, New York, 1994.
- John L. Hennessy and David A. Patterson, *Computer Architecture*, Morgan Kaufmann Publishers, San Mateo, CA, 1996.
- Thom Hogan, *The Programmer's PC Sourcebook*, Microsoft Press, Redmond, WA, 1991.
- Hal Katircioglu, *Inside the 486, Pentium, and Pentium Pro*, Peer-to-Peer Communications, Menlo Park, CA, 1997.
- IBM Corporation, *486SLC Microprocessor Data Sheet*, IBM Corporation, Essex Junction, VT, 1993.
- IBM Corporation, *486SLC2 Microprocessor Data Sheet*, IBM Corporation, Essex Junction, VT, 1993.
- IBM Corporation, *80486DX2 Processor Floating Point Instructions*, IBM Corporation, Essex Junction, VT, 1995.
- IBM Corporation, *80486DX2 Processor BIOS Writer's Guide*, IBM Corporation, Essex Junction, VT, 1995.
- IBM Corporation, *Blue Lightning 486DX2 Data Book*, IBM Corporation, Essex Junction, VT, 1994.
- Institute of Electrical and Electronics Engineers, *IEEE Standard for Binary Floating-Point Arithmetic*, ANSI/IEEE Std 754-1985.
- Institute of Electrical and Electronics Engineers, *IEEE Standard for Radix-Independent Floating-Point Arithmetic*, ANSI/IEEE Std 854-1987.
- Muhammad Ali Mazidi and Janice Gillispie Mazidi, *80X86 IBM PC and Compatible Computers*, Prentice-Hall, Englewood Cliffs, NJ, 1997.
- Hans-Peter Messmer, *The Indispensable Pentium Book*, Addison-Wesley, New York, 1995.
- Karen Miller, *An Assembly Language Introduction to Computer Architecture: Using the Intel Pentium*, Oxford University Press, New York, 1999.
- Stephen Morse, Eric Isaacson, and Douglas Albert, *The 80386/387 Architecture*, John Wiley & Sons, New York, 1987.
- NexGen Inc., *Nx586TM Processor Data Book*, NexGen Inc., Milpitas, CA, 1993.
- NexGen Inc., *Nx686TM Processor Data Book*, NexGen Inc., Milpitas, CA, 1994.

- Bipin Patwardhan, *Introduction to the Streaming SIMD Extensions in the Pentium® III*, www.x86.org/articles/sse_pt1/simd1.htm, June, 2000.
- Peter Norton, Peter Aitken, and Richard Wilton, *PC Programmer's Bible*, Microsoft Press, Redmond, WA, 1993.
- *PharLap 386/ASM Reference Manual*, Pharlap, Cambridge MA, 1993.
- *PharLap TNT DOS-Extender Reference Manual*, Pharlap, Cambridge MA, 1995.
- Sen-Cuo Ro and Sheau-Chuen Her, *i386/i486 Advanced Programming*, Van Nostrand Reinhold, New York, 1993.
- Jeffrey P. Royer, *Introduction to Protected Mode Programming*, course materials for an onsite class, 1992.
- Tom Shanley, *Protected Mode System Architecture*, Addison Wesley, NY, 1996.
- SGS-Thomson Corporation, *80486DX Processor SMM Programming Manual*, SGS-Thomson Corporation, 1995.
- Walter A. Triebel, *The 80386DX Microprocessor*, Prentice-Hall, Englewood Cliffs, NJ, 1992.
- John Wharton, *The Complete x86*, MicroDesign Resources, Sebastopol, California, 1994.
- Web sites and newsgroups:
 - www.amd.com
 - news.comp.arch
 - news.comp.lang.asm.x86
 - news.intel.microprocessors
 - news.microsoft

1 System-Programming Overview

This entire volume is intended for system-software developers—programmers writing operating systems, loaders, linkers, device drivers, or utilities that require access to system resources. These system resources are generally available only to software running at the highest-privilege level (CPL=0), also referred to as *privileged software*. Privilege levels and their interactions are fully described in “Segment-Protection Overview” on page 93.

This chapter introduces the basic features and capabilities of the AMD64 architecture that are available to system-software developers. The concepts include:

- The supported address forms and how memory is organized.
- How memory-management hardware makes use of the various address forms to access memory.
- The processor operating modes, and how the memory-management hardware supports each of those modes.
- The system-control registers used to manage system resources.
- The interrupt and exception mechanism, and how it is used to interrupt program execution and to report errors.
- Additional, miscellaneous features available to system software, including support for hardware multitasking, reporting machine-check exceptions, debugging software problems, and optimizing software performance.

Many of the legacy features and capabilities are enhanced by the AMD64 architecture to support 64-bit operating systems and applications, while providing backward-compatibility with existing software.

1.1 Memory Model

The AMD64 architecture memory model is designed to allow system software to manage application software and associated data in a secure fashion. The memory model is backward-compatible with the legacy memory model. Hardware-translation mechanisms are provided to map addresses between virtual-memory space and physical-memory space. The translation mechanisms allow system software to relocate applications and data transparently, either anywhere in physical-memory space, or in areas on the system hard drive managed by the operating system.

In long mode, the AMD64 architecture implements a flat-memory model. In legacy mode, the architecture implements all legacy memory models.

1.1.1 Memory Addressing

The AMD64 architecture supports address relocation. To do this, several types of addresses are needed to completely describe memory organization. Specifically, four types of addresses are defined by the AMD64 architecture:

- Logical addresses
- Effective addresses, or segment offsets, which are a portion of the logical address.
- Linear (virtual) addresses
- Physical addresses

Logical Addresses. A *logical address* is a reference into a segmented-address space. It is comprised of the segment selector and the effective address. Notationally, a logical address is represented as

Logical Address = Segment Selector : Offset

The segment selector specifies an entry in either the global or local descriptor table. The specified descriptor-table entry describes the segment location in virtual-address space, its size, and other characteristics. The effective address is used as an offset into the segment specified by the selector.

Logical addresses are often referred to as *far pointers*. Far pointers are used in software addressing when the segment reference must be explicit (i.e., a reference to a segment outside the current segment).

Effective Addresses. The offset into a memory segment is referred to as an effective address (see “Segmentation” on page 5 for a description of segmented memory). Effective addresses are formed by adding together elements comprising a base value, a scaled-index value, and a displacement value. The effective-address computation is represented by the equation

Effective Address = Base + (Scale x Index) + Displacement

The elements of an effective-address computation are defined as follows:

- *Base*—A value stored in any general-purpose register.
- *Scale*—A positive value of 1, 2, 4, or 8.
- *Index*—A two’s-complement value stored in any general-purpose register.
- *Displacement*—An 8-bit, 16-bit, or 32-bit two’s-complement value encoded as part of the instruction.

Effective addresses are often referred to as *near pointers*. A near pointer is used when the segment selector is known implicitly or when the flat-memory model is used.

Long mode defines a 64-bit effective-address length. If a processor implementation does not support the full 64-bit virtual-address space, the effective address must be in *canonical form* (see “Canonical Address Form” on page 4).

Linear (Virtual) Addresses. The segment-selector portion of a logical address specifies a segment-descriptor entry in either the global or local descriptor table. The specified segment-descriptor entry contains the segment-base address, which is the starting location of the segment in linear-address space. A *linear address* is formed by adding the segment-base address to the effective address (segment offset), which creates a reference to any byte location within the supported linear-address space. Linear addresses are often referred to as *virtual addresses*, and both terms are used interchangeably throughout this document.

Linear Address = Segment Base Address + Effective Address

When the flat-memory model is used—as in 64-bit mode—a segment-base address is treated as 0. In this case, the linear address is identical to the effective address. In long mode, linear addresses must be in canonical address form, as described in “Canonical Address Form” on page 4.

Physical Addresses. A *physical address* is a reference into the physical-address space, typically main memory. Physical addresses are translated from virtual addresses using page-translation mechanisms. See “Paging” on page 7 for information on how the paging mechanism is used for virtual-address to physical-address translation. When the paging mechanism is not enabled, the virtual (linear) address is used as the physical address.

1.1.2 Memory Organization

The AMD64 architecture organizes memory into *virtual memory* and *physical memory*. Virtual-memory and physical-memory spaces can be (and usually are) different in size. Generally, the virtual-address space is much larger than physical-address memory. System software relocates applications and data between physical memory and the system hard disk to make it appear that much more memory is available than really exists. System software then uses the hardware memory-management mechanisms to map the larger virtual-address space into the smaller physical-address space.

Virtual Memory. Software uses virtual addresses to access locations within the virtual-memory space. System software is responsible for managing the relocation of applications and data in virtual-memory space using segment-memory management. System software is also responsible for mapping virtual memory to physical memory through the use of page translation. The AMD64 architecture supports different virtual-memory sizes using the following address-translation modes:

- *Protected Mode*—This mode supports 4 gigabytes of virtual-address space using 32-bit virtual addresses.
- *Long Mode*—This mode supports 16 exabytes of virtual-address space using 64-bit virtual addresses.

Physical Memory. Physical addresses are used to directly access main memory. For a particular computer system, the size of the *available* physical-address space is equal to the amount of main memory installed in the system. The maximum amount of physical memory accessible depends on the processor implementation and on the address-translation mode. The AMD64 architecture supports varying physical-memory sizes using the following address-translation modes:

- *Real-Address Mode*—This mode, also called *real mode*, supports 1 megabyte of physical-address space using 20-bit physical addresses. This address-translation mode is described in “Real Addressing” on page 10. Real mode is available only from legacy mode (see “Legacy Modes” on page 14).
- *Legacy Protected Mode*—This mode supports several different address-space sizes, depending on the translation mechanism used and whether extensions to those mechanisms are enabled.

Legacy protected mode supports 4 gigabytes of physical-address space using 32-bit physical addresses. Both segment translation (see “Segmentation” on page 5) and page translation (see “Paging” on page 7) can be used to access the physical address space, when the processor is running in legacy protected mode.

When the physical-address size extensions are enabled (see “Physical-Address Extensions (PAE) Bit” on page 119), the page-translation mechanism can be extended to support 52-bit physical addresses. 52-bit physical addresses allow up to 4 petabytes of physical-address space to be supported. (Currently, the AMD64 architecture supports 40-bit addresses in this mode, allowing up to 1 terabyte of physical-address space to be supported.)

- *Long Mode*—This mode is unique to the AMD64 architecture. This mode supports up to 4 petabytes of physical-address space using 52-bit physical addresses. Long mode requires the use of page-translation and the physical-address size extensions (PAE).

1.1.3 Canonical Address Form

Long mode defines 64 bits of virtual-address space, but processor implementations can support less. Although some processor implementations do not use all 64 bits of the virtual address, they all check bits 63 through the most-significant implemented bit to see if those bits are all zeros or all ones. An address that complies with this property is in *canonical address form*. In most cases, a virtual-memory reference that is not in canonical form causes a general-protection exception (#GP) to occur. However, implied stack references where the stack address is not in canonical form causes a stack exception (#SS) to occur. Implied stack references include all push and pop instructions, and any instruction using RSP or RBP as a base register.

By checking canonical-address form, the AMD64 architecture prevents software from exploiting unused high bits of pointers for other purposes. Software complying with canonical-address form on a specific processor implementation can run unchanged on long-mode implementations supporting larger virtual-address spaces.

1.2 Memory Management

Memory management consists of the methods by which addresses generated by software are translated by segmentation and/or paging into addresses in physical memory. Memory management is not visible to application software. It is handled by the system software and processor hardware.

1.2.1 Segmentation

Segmentation was originally created as a method by which system software could isolate software processes (tasks), and the data used by those processes, from one another in an effort to increase the reliability of systems running multiple processes simultaneously.

The AMD64 architecture is designed to support all forms of legacy segmentation. However, most modern system software does not use the segmentation features available in the legacy x86 architecture. Instead, system software typically handles program and data isolation using page-level protection. For this reason, the AMD64 architecture dispenses with multiple segments in 64-bit mode and, instead, uses a flat-memory model. The elimination of segmentation allows new 64-bit system software to be coded more simply, and it supports more efficient management of multi-processing than is possible in the legacy x86 architecture.

Segmentation is, however, used in compatibility mode and legacy mode. Here, segmentation is a form of base memory-addressing that allows software and data to be relocated in virtual-address space off of an arbitrary base address. Software and data can be relocated in virtual-address space using one or more variable-sized *memory segments*. The legacy x86 architecture provides several methods of restricting access to segments from other segments so that software and data can be protected from interfering with each other.

In compatibility and legacy modes, up to 16,383 unique segments can be defined. The base-address value, segment size (called a *limit*), protection, and other attributes for each segment are contained in a data structure called a *segment descriptor*. Collections of segment descriptors are held in *descriptor tables*. Specific segment descriptors are referenced or selected from the descriptor table using a *segment selector register*. Six segment-selector registers are available, providing access to as many as six segments at a time.

Figure 1-1 on page 6 shows an example of segmented memory. Segmentation is described in Chapter 4, “Segmented Virtual Memory.”

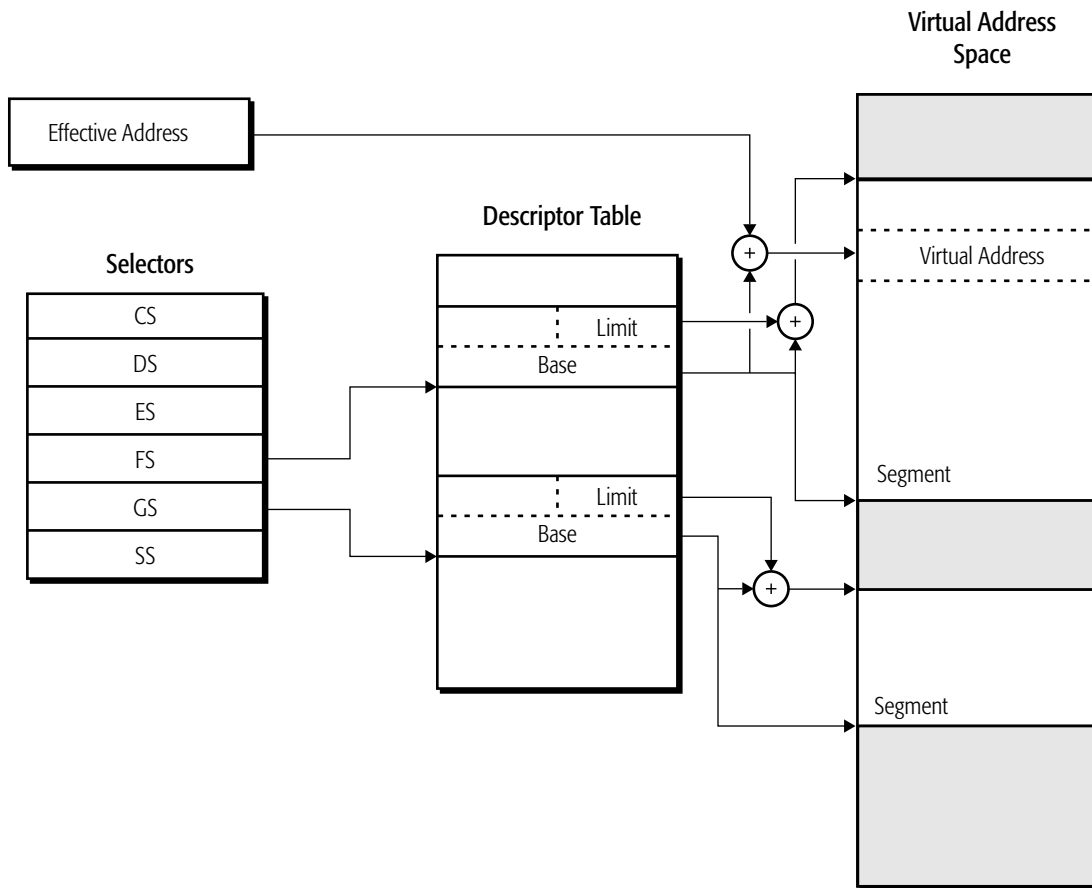

513-201.eps

Figure 1-1. Segmented-Memory Model

Flat Segmentation. One special case of segmented memory is the flat-memory model. In the legacy flat-memory model, all segment-base addresses have a value of 0, and the segment limits are fixed at 4 Gbytes. Segmentation cannot be disabled but use of the flat-memory model effectively disables segment translation. The result is a virtual address that equals the effective address. Figure 1-2 on page 7 shows an example of the flat-memory model.

Software running in 64-bit mode automatically uses the flat-memory model. In 64-bit mode, the segment base is treated as if it were 0, and the segment limit is ignored. This allows an effective addresses to access the full virtual-address space supported by the processor.

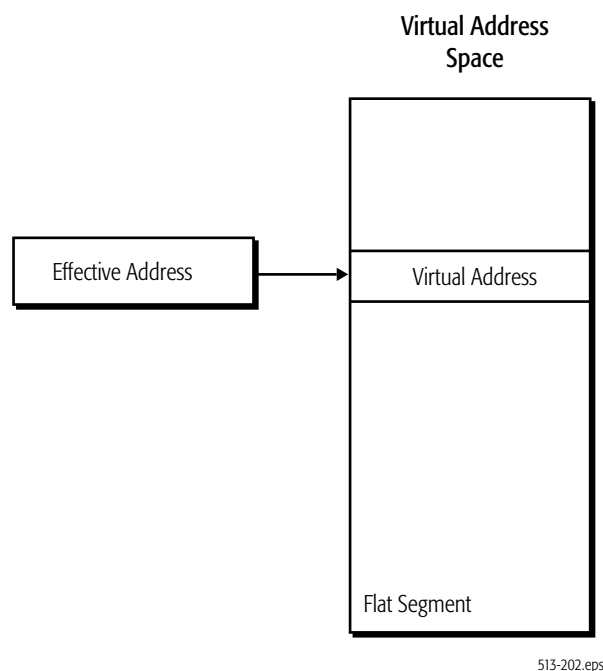

Figure 1-2. Flat Memory Model

1.2.2 Paging

Paging allows software and data to be relocated in physical-address space using fixed-size blocks called *physical pages*. The legacy x86 architecture supports three different physical-page sizes of 4 Kbytes, 2 Mbytes, and 4 Mbytes. As with segment translation, access to physical pages by lesser-privileged software can be restricted.

Page translation uses a hierarchical data structure called a page-translation table to translate virtual pages into physical-pages. The number of levels in the translation-table hierarchy can be as few as one or as many as four, depending on the physical-page size and processor operating mode. Translation tables are aligned on 4-Kbyte boundaries. Physical pages must be aligned on 4-Kbyte, 2-Mbyte, or 4-Mbyte boundaries, depending on the physical-page size.

Each table in the translation hierarchy is indexed by a portion of the virtual-address bits. The entry referenced by the table index contains a pointer to the base address of the next-lower-level table in the translation hierarchy. In the case of the lowest-level table, its entry points to the physical-page base address. The physical page is then indexed by the least-significant bits of the virtual address to yield the physical address.

Figure 1-3 on page 8 shows an example of paged memory with three levels in the translation-table hierarchy. Paging is described in Chapter 5, “Page Translation and Protection.”

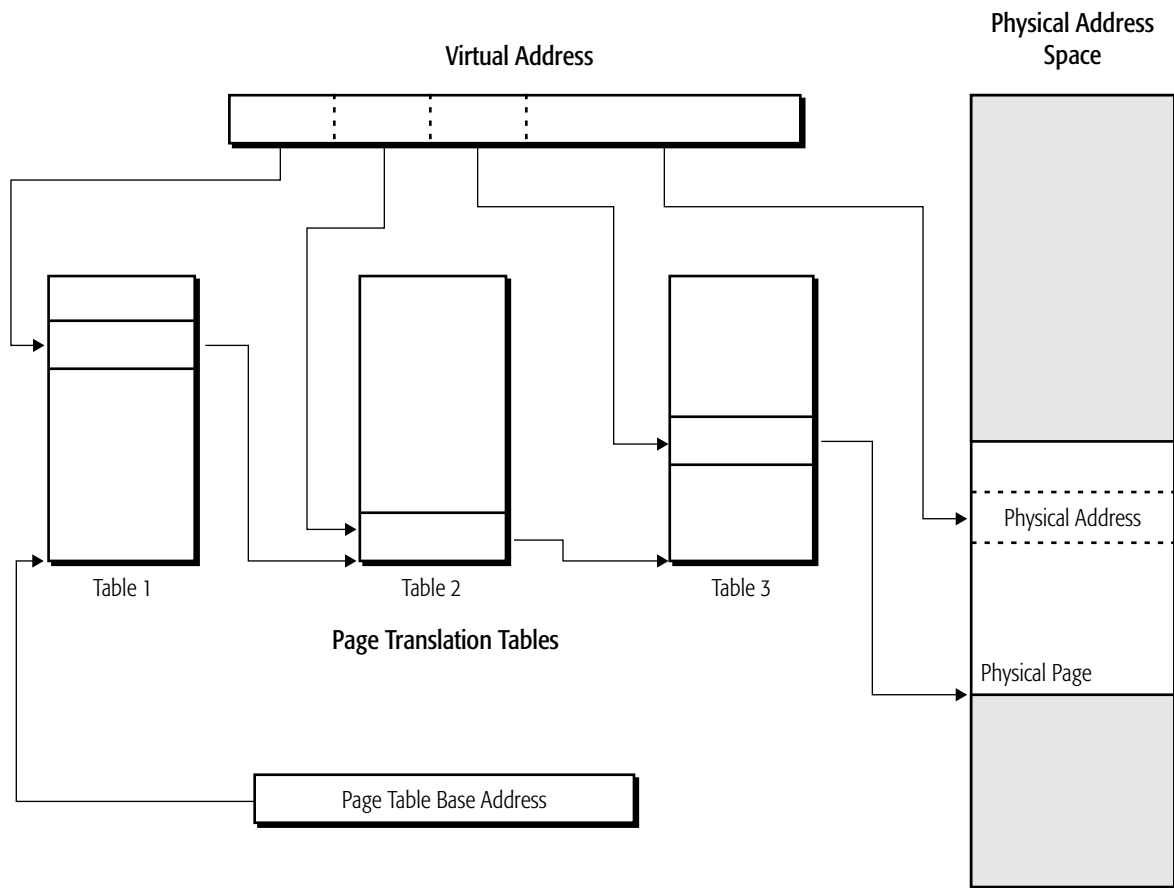

513-203.eps

Figure 1-3. Paged Memory Model

Software running in long mode is required to have page translation enabled.

1.2.3 Mixing Segmentation and Paging

Memory-management software can combine the use of segmented memory and paged memory. Because segmentation cannot be disabled, paged-memory management requires some minimum initialization of the segmentation resources. Paging can be completely disabled, so segmented-memory management does not require initialization of the paging resources.

Segments can range in size from a single byte to 4 Gbytes in length. It is therefore possible to map multiple segments to a single physical page and to map multiple physical pages to a single segment. Alignment between segment and physical-page boundaries is not required, but memory-management software is simplified when segment and physical-page boundaries are aligned.

The simplest, most efficient method of memory management is the flat-memory model. In the flat-memory model, all segment base addresses have a value of 0 and the segment limits are fixed at 4 Gbytes. The segmentation mechanism is still used each time a memory reference is made, but because virtual addresses are identical to effective addresses in this model, the segmentation mechanism is effectively ignored. Translation of virtual (or effective) addresses to physical addresses takes place using the paging mechanism only.

Because 64-bit mode disables segmentation, it uses a flat, paged-memory model for memory management. The 4 Gbyte segment limit is ignored in 64-bit mode. Figure 1-4 shows an example of this model.

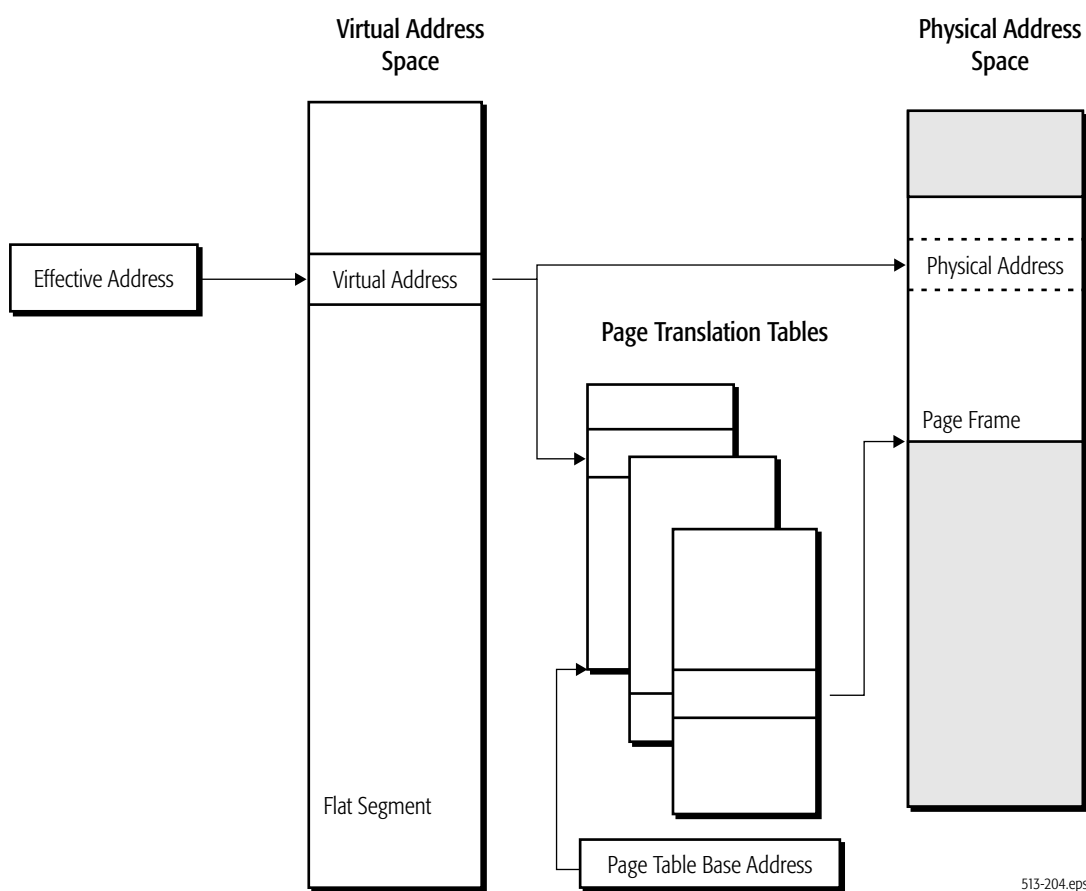

Figure 1-4. 64-Bit Flat, Paged-Memory Model

1.2.4 Real Addressing

Real addressing is a legacy-mode form of address translation used in real mode. This simplified form of address translation is backward compatible with 8086-processor effective-to-physical address translation. In this mode, 16-bit effective addresses are mapped to 20-bit physical addresses, providing a 1-Mbyte physical-address space.

Segment selectors are used in real-address translation, but not as an index into a descriptor table. Instead, the 16-bit segment-selector value is shifted left by 4 bits to form a 20-bit segment-base address. The 16-bit effective address is added to this 20-bit segment base address to yield a 20-bit physical address. If the sum of the segment base and effective address carries over into bit 20, that bit can be optionally truncated to mimic the 20-bit address wrapping of the 8086 processor by using the A20M# input signal to mask the A20 address bit.

Real-address translation supports a 1-Mbyte physical-address space using up to 64K segments aligned on 16-byte boundaries. Each segment is exactly 64K bytes long. Figure 1-5 shows an example of real-address translation.

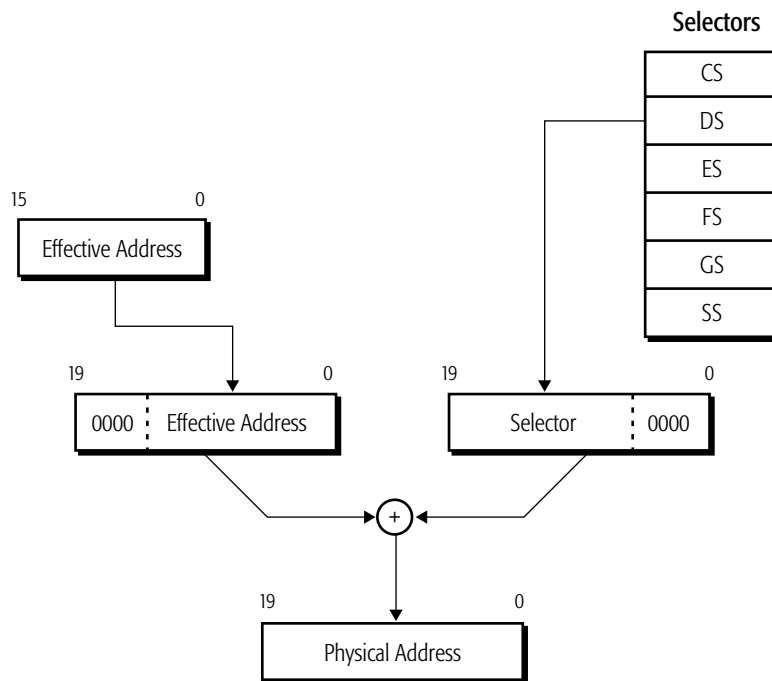

513-205.eps

Figure 1-5. Real-Address Memory Model

1.3 Operating Modes

The legacy x86 architecture provides four operating modes or environments that support varying forms of memory management, virtual-memory and physical-memory sizes, and protection:

- Real Mode.
- Protected Mode.
- Virtual-8086 Mode.
- System Management Mode.

The AMD64 architecture supports all these legacy modes, and it adds a new operating mode called *long mode*. Table 1-1 shows the differences between long mode and legacy mode. Software can move between all supported operating modes as shown in Figure 1-6 on page 12. Each operating mode is described in the following sections.

Table 1-1. Operating Modes

Mode		System Software Required	Application Recompile Required	Defaults ¹		Register Extensions ²	Maximum GPR Width (bits)
				Address Size (bits)	Operand Size (bits)		
Long Mode ³	64-Bit Mode	New 64-bit OS	yes	64	32	yes	64
	Compatibility Mode		no	32		16	no
		16					
Legacy Mode	Protected Mode	Legacy 32-bit OS	no	32	32	no	32
	Virtual-8086 Mode			16	16		32
		Real Mode		Legacy 16-bit OS	16		

Note:

1. Defaults can be overridden in most modes using an instruction prefix or system control bit.
2. Register extensions includes eight new GPRs and eight new XMM registers (also called SSE registers).
3. Long mode supports only x86 protected mode. It does not support x86 real mode or virtual-8086 mode.

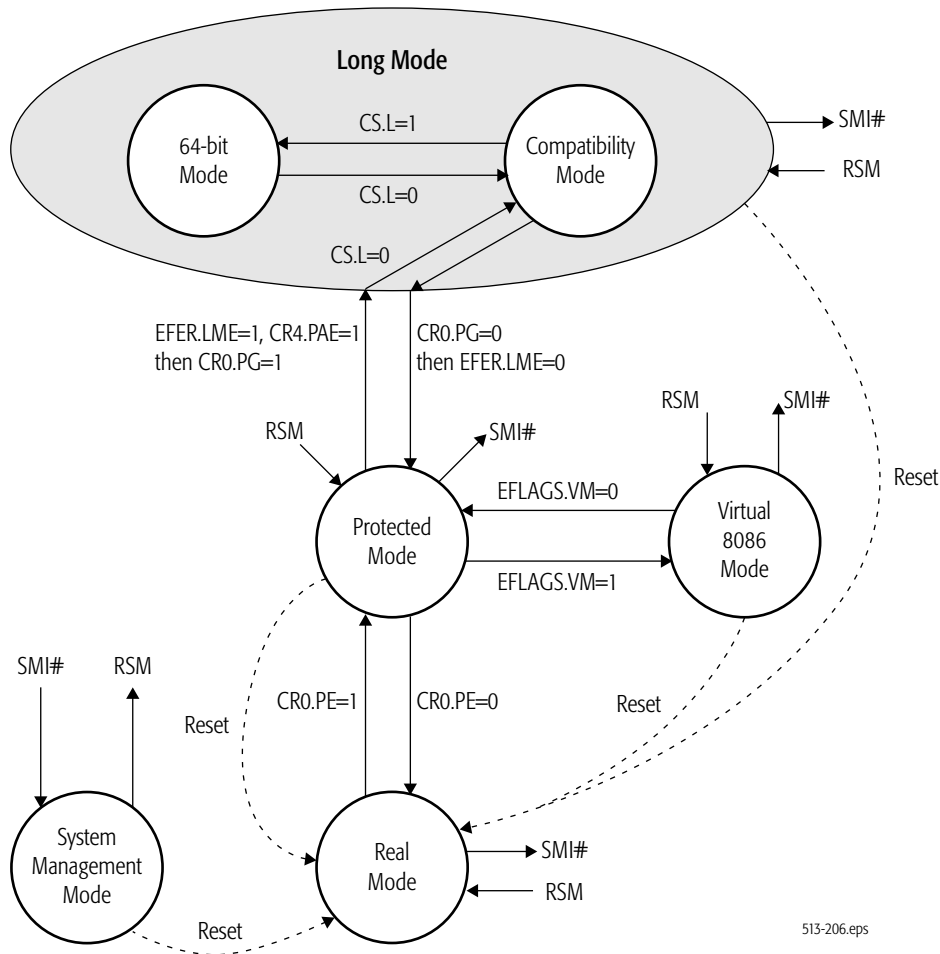

Figure 1-6. Operating Modes of the AMD64 Architecture

1.3.1 Long Mode

Long mode consists of two submodes: *64-bit mode* and *compatibility mode*. 64-bit mode supports several new features, including the ability to address 64-bit virtual-address space. Compatibility mode provides binary compatibility with existing 16-bit and 32-bit applications when running on 64-bit system software.

Throughout this document, references to *long mode* refer collectively to both *64-bit mode* and *compatibility mode*. If a function is specific to either 64-bit mode or compatibility mode, then those specific names are used instead of the name *long mode*.

Before enabling and activating long mode, system software must first enable protected mode. The process of enabling and activating long mode is described in Chapter 14, “Processor Initialization and

Long Mode Activation.” Long mode features are described throughout this document, where applicable.

1.3.2 64-Bit Mode

64-bit mode, a submode of long mode, provides support for 64-bit system software and applications by adding the following new features:

- 64-bit virtual addresses (processor implementations can have fewer).
- Register extensions through a new instruction prefix (REX):
 - Adds eight GPRs (R8–R15).
 - Widens GPRs to 64 bits.
 - Adds eight 128-bit streaming SIMD extension (SSE) registers (XMM8–XMM15).
- 64-bit instruction pointer (RIP).
- New RIP-relative data-addressing mode.
- Flat-segment address space with single code, data, and stack space.

The mode is enabled by the system software on an individual code-segment basis. Although code segments are used to enable and disable 64-bit mode, the legacy segmentation mechanism is largely disabled. Page translation is required for memory management purposes. Because 64-bit mode supports a 64-bit virtual-address space, it requires 64-bit system software and development tools.

In 64-bit mode, the default address size is 64 bits, and the default operand size is 32 bits. The defaults can be overridden on an instruction-by-instruction basis using instruction prefixes. A new REX prefix is introduced for specifying a 64-bit operand size and the new registers.

1.3.3 Compatibility Mode

Compatibility mode, a submode of long mode, allows system software to implement binary compatibility with existing 16-bit and 32-bit x86 applications. It allows these applications to run, without recompilation, under 64-bit system software in long mode, as shown in Table 1-1 on page 11.

In compatibility mode, applications can only access the first 4 Gbytes of virtual-address space. Standard x86 instruction prefixes toggle between 16-bit and 32-bit address and operand sizes.

Compatibility mode, like 64-bit mode, is enabled by system software on an individual code-segment basis. Unlike 64-bit mode, however, segmentation functions the same as in the legacy-x86 architecture, using 16-bit or 32-bit protected-mode semantics. From an application viewpoint, compatibility mode looks like a legacy protected-mode environment. From a system-software viewpoint, the long-mode mechanisms are used for address translation, interrupt and exception handling, and system data-structures.

1.3.4 Legacy Modes

Legacy mode consists of three submodes: real mode, protected mode, and virtual-8086 mode. Protected mode can be either paged or unpaged. *Legacy mode* preserves binary compatibility not only with existing x86 16-bit and 32-bit applications but also with existing x86 16-bit and 32-bit system software.

Real Mode. In this mode, also called real-address mode, the processor supports a physical-memory space of 1 Mbyte and operand sizes of 16 bits (default) or 32 bits (with instruction prefixes). Interrupt handling and address generation are nearly identical to the 80286 processor's real mode. Paging is not supported. All software runs at privilege level 0.

Real mode is entered after reset or processor power-up. The mode is not supported when the processor is operating in long mode because long mode requires that paged protected mode be enabled.

Protected Mode. In this mode, the processor supports virtual-memory and physical-memory spaces of 4 Gbytes and operand sizes of 16 or 32 bits. All segment translation, segment protection, and hardware multitasking functions are available. System software can use segmentation to relocate effective addresses in virtual-address space. If paging is not enabled, virtual addresses are equal to physical addresses. Paging can be optionally enabled to allow translation of virtual addresses to physical addresses and to use the page-based memory-protection mechanisms.

In protected mode, software runs at privilege levels 0, 1, 2, or 3. Typically, application software runs at privilege level 3, the system software runs at privilege levels 0 and 1, and privilege level 2 is available to system software for other uses. The 16-bit version of this mode was first introduced in the 80286 processor.

Virtual-8086 Mode. Virtual-8086 mode allows system software to run 16-bit real-mode software on a virtualized-8086 processor. In this mode, software written for the 8086, 8088, 80186, or 80188 processor can run as a privilege-level-3 task under protected mode. The processor supports a virtual-memory space of 1 Mbytes and operand sizes of 16 bits (default) or 32 bits (with instruction prefixes), and it uses real-mode address translation.

Virtual-8086 mode is enabled by setting the virtual-machine bit in the EFLAGS register (EFLAGS.VM). EFLAGS.VM can only be set or cleared when the EFLAGS register is loaded from the TSS as a result of a task switch, or by executing an IRET instruction from privileged software. The POPF instruction cannot be used to set or clear the EFLAGS.VM bit.

Virtual-8086 mode is not supported when the processor is operating in long mode. When long mode is enabled, any attempt to enable virtual-8086 mode is silently ignored.

1.3.5 System Management Mode (SMM)

System management mode (SMM) is an operating mode designed for system-control activities that are typically transparent to conventional system software. Power management is one popular use for system management mode. SMM is primarily targeted for use by the basic input-output system (BIOS) and specialized low-level device drivers. The code and data for SMM are stored in the SMM memory area, which is isolated from main memory by the SMM output signal.

SMM is entered by way of a system management interrupt (SMI). Upon recognizing an SMI, the processor enters SMM and switches to a separate address space where the SMM handler is located and executes. In SMM, the processor supports real-mode addressing with 4 Gbyte segment limits and default operand, address, and stack sizes of 16 bits (prefixes can be used to override these defaults).

1.4 System Registers

Figure 1-7 on page 16 shows the system registers defined for the AMD64 architecture. System software uses these registers to, among other things, manage the processor operating environment, define system resource characteristics, and to monitor software execution. With the exception of the RFLAGS register, system registers can be read and written only from privileged software.

Except for the descriptor-table registers and task register, the AMD64 architecture defines all system registers to be 64 bits wide. The descriptor table and task registers are defined by the AMD64 architecture to include 64-bit base-address fields, in addition to their other fields.

As shown in Figure 1-7 on page 16, the system registers include:

- *Control Registers*—These registers are used to control system operation and some system features. See “System-Control Registers” on page 41 for details.
- *System-Flags Register*—The RFLAGS register contains system-status flags and masks. It is also used to enable virtual-8086 mode and to control application access to I/O devices and interrupts. See “RFLAGS Register” on page 50 for details.
- *Descriptor-Table Registers*—These registers contain the location and size of descriptor tables stored in memory. Descriptor tables hold segmentation data structures used in protected mode. See “Descriptor Tables” on page 71 for details.
- *Task Register*—The task register contains the location and size in memory of the task-state segment. The hardware-multitasking mechanism uses the task-state segment to hold state information for a given task. The TSS also holds other data, such as the inner-level stack pointers used when changing to a higher privilege level. See “Task Register” on page 311 for details.
- *Debug Registers*—Debug registers are used to control the software-debug mechanism, and to report information back to a debug utility or application. See “Debug Registers” on page 328 for details.

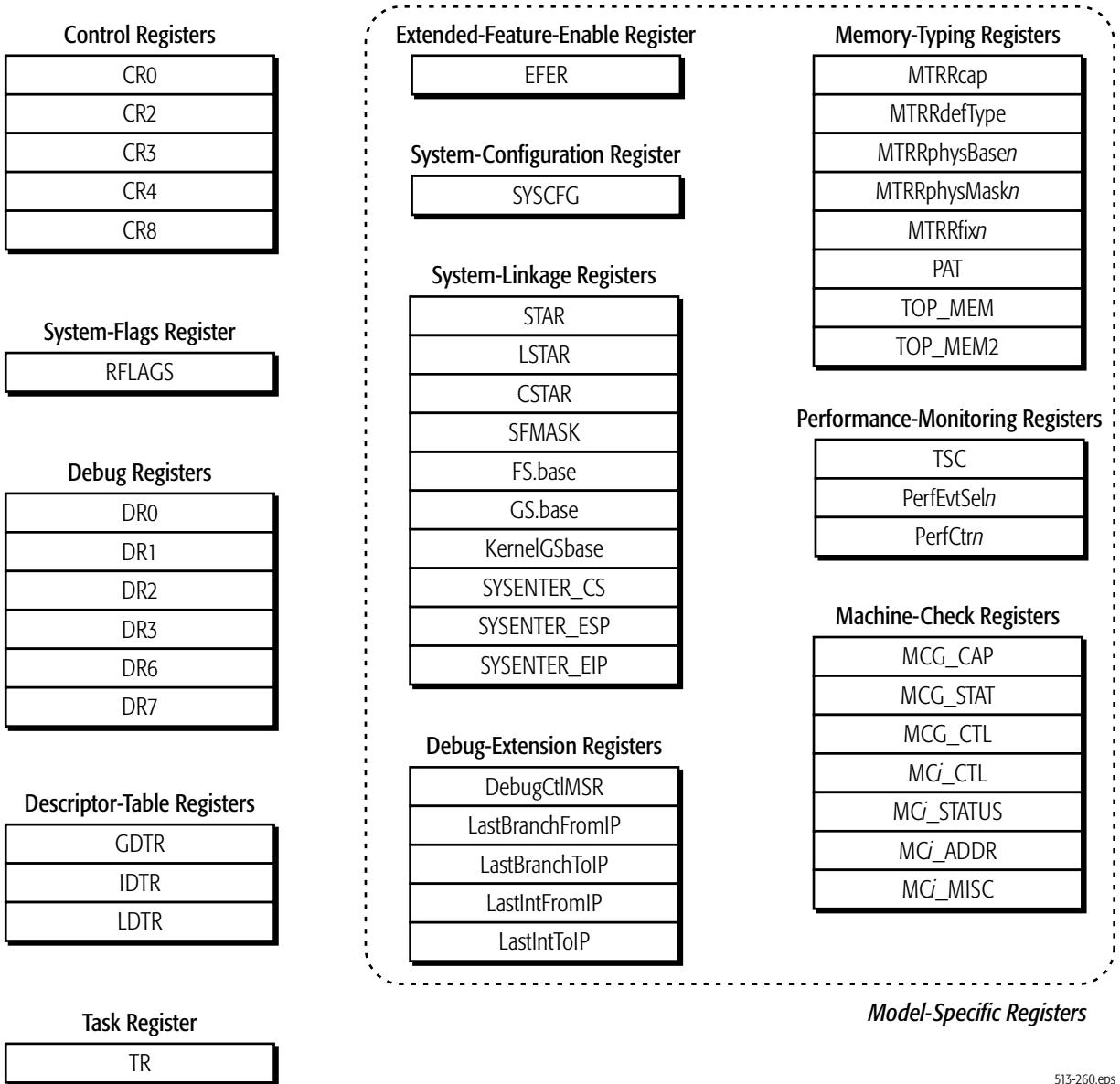

513-260.eps

Figure 1-7. System Registers

Also defined as system registers are a number of *model-specific registers* included in the AMD64 architectural definition, and shown in Figure 1-7:

- *Extended-Feature-Enable Register*—The EFER register is used to enable and report status on special features not controlled by the CR n control registers. In particular, EFER is used to control activation of long mode. See “Extended Feature Enable Register (EFER)” on page 54 for more information.

- *System-Configuration Register*—The SYSCFG register is used to enable and configure system-bus features. See “System Configuration Register (SYSCFG)” on page 57 for more information.
- *System-Linkage Registers*—These registers are used by system-linkage instructions to specify operating-system entry points, stack locations, and pointers into system-data structures. See “Fast System Call and Return” on page 149 for details.
- *Memory-Typing Registers*—Memory-typing registers can be used to characterize (type) system memory. Typing memory gives system software control over how instructions and data are cached, and how memory reads and writes are ordered. See “MTRRs” on page 184 for details.
- *Debug-Extension Registers*—These registers control additional software-debug reporting features. See “Debug Registers” on page 328 for details.
- *Performance-Monitoring Registers*—Performance-monitoring registers are used to count processor and system events, or the duration of events. See “Performance Optimization” on page 341 for more information.
- *Machine-Check Registers*—The machine-check registers control the response of the processor to non-recoverable failures. They are also used to report information on such failures back to system utilities designed to respond to such failures. See “Machine Check MSRs” on page 256 for more information.

1.5 System-Data Structures

Figure 1-8 on page 18 shows the system-data structures defined for the AMD64 architecture. System-data structures are created and maintained by system software for use by the processor when running in protected mode. A processor running in protected mode uses these data structures to manage memory and protection, and to store program-state information when an interrupt or task switch occurs.

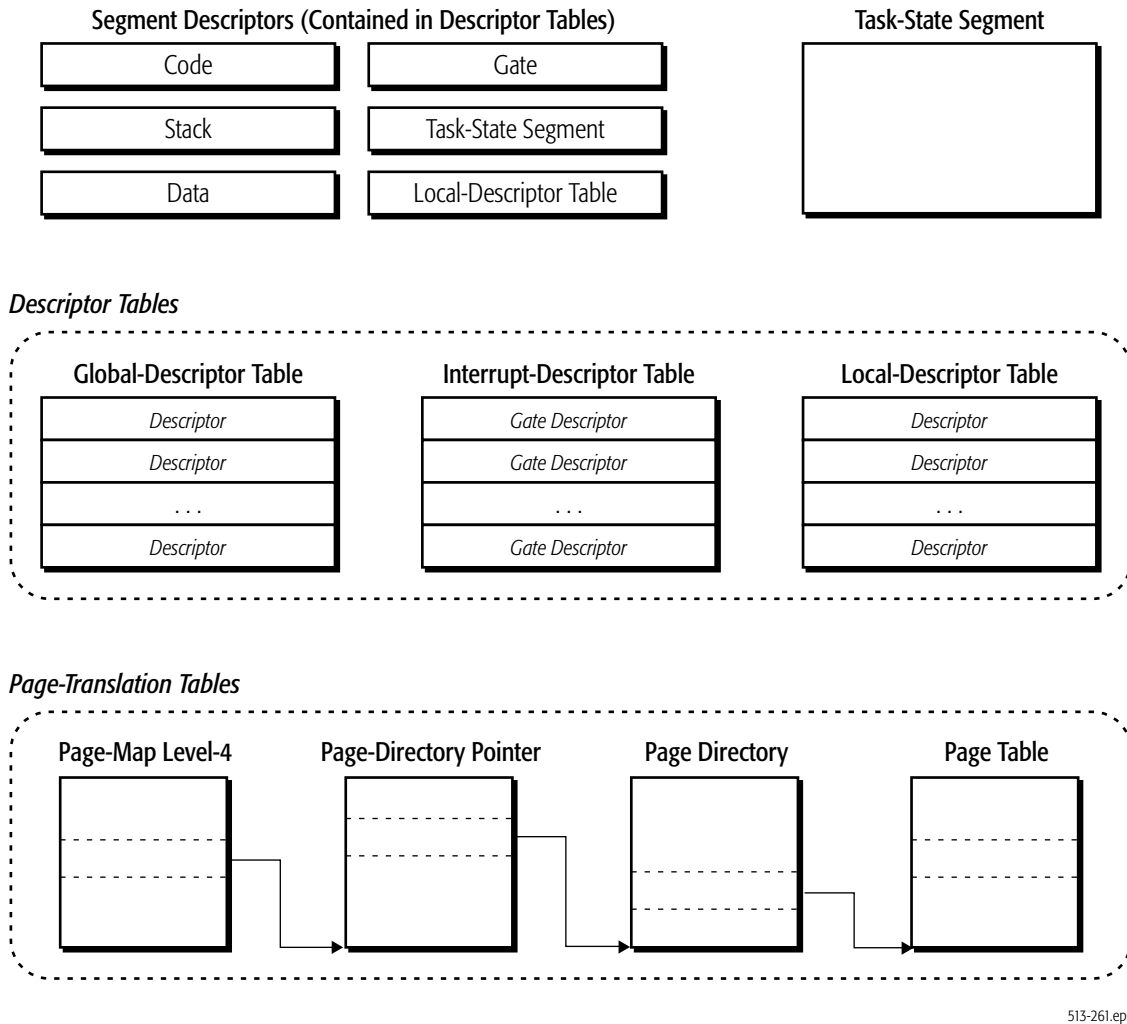

Figure 1-8. System-Data Structures

As shown in Figure 1-8, the system-data structures include:

- *Descriptors*—A descriptor provides information about a segment to the processor, such as its location, size and privilege level. A special type of descriptor, called a *gate*, is used to provide a code selector and entry point for a software routine. Any number of descriptors can be defined, but system software must at a minimum create a descriptor for the currently executing code segment and stack segment. See “Legacy Segment Descriptors” on page 77, and “Long-Mode Segment Descriptors” on page 86 for complete information on descriptors.
- *Descriptor Tables*—As the name implies, descriptor tables hold descriptors. The global-descriptor table holds descriptors available to all programs, while a local-descriptor table holds descriptors used by a single program. The interrupt-descriptor table holds only gate descriptors used by

interrupt handlers. System software must initialize the global-descriptor and interrupt-descriptor tables, while use of the local-descriptor table is optional. See “Descriptor Tables” on page 71 for more information.

- *Task-State Segment*—The task-state segment is a special segment for holding processor-state information for a specific program, or task. It also contains the stack pointers used when switching to more-privileged programs. The hardware multitasking mechanism uses the state information in the segment when suspending and resuming a task. Calls and interrupts that switch stacks cause the stack pointers to be read from the task-state segment. System software must create at least one task-state segment, even if hardware multitasking is not used. See “Legacy Task-State Segment” on page 313, and “64-Bit Task State Segment” on page 317 for details.
- *Page-Translation Tables*—Use of page translation is optional in protected mode, but it is required in long mode. A four-level page-translation data structure is provided to allow long-mode operating systems to translate a 64-bit virtual-address space into a 52-bit physical-address space. Legacy protected mode can use two- or three-level page-translation data structures. See “Page Translation Overview” on page 115 for more information on page translation.

1.6 Interrupts

The AMD64 architecture provides a mechanism for the processor to automatically suspend (interrupt) software execution and transfer control to an interrupt handler when an interrupt or exception occurs. An interrupt handler is privileged software designed to identify and respond to the cause of an interrupt or exception, and return control back to the interrupted software. *Interrupts* can be caused when system hardware signals an interrupt condition using one of the external-interrupt signals on the processor. Interrupts can also be caused by software that executes an interrupt instruction. *Exceptions* occur when the processor detects an abnormal condition as a result of executing an instruction. The term “interrupts” as used throughout this volume includes both interrupts and exceptions when the distinction is unnecessary.

System software not only sets up the interrupt handlers, but it must also create and initialize the data structures the processor uses to execute an interrupt handler when an interrupt occurs. The data structures include the code-segment descriptors for the interrupt-handler software and any data-segment descriptors for data and stack accesses. Interrupt-gate descriptors must also be supplied. Interrupt gates point to interrupt-handler code-segment descriptors, and the entry point in an interrupt handler. Interrupt gates are stored in the interrupt-descriptor table. The code-segment and data-segment descriptors are stored in the global-descriptor table and, optionally, the local-descriptor table.

When an interrupt occurs, the processor uses the interrupt vector to find the appropriate interrupt gate in the interrupt-descriptor table. The gate points to the interrupt-handler code segment and entry point, and the processor transfers control to that location. Before invoking the interrupt handler, the processor saves information required to return to the interrupted program. For details on how the processor transfers control to interrupt handlers, see “Legacy Protected-Mode Interrupt Control Transfers” on page 231, and “Long-Mode Interrupt Control Transfers” on page 241.

Table 1-2 shows the supported interrupts and exceptions, ordered by their vector number. Refer to “Vectors” on page 208 for a complete description of each interrupt, and a description of the interrupt mechanism.

Table 1-2. Interrupts and Exceptions

Vector	Description
0	Integer Divide-by-Zero Exception
1	Debug Exception
2	Non-Maskable-Interrupt
3	Breakpoint Exception (INT 3)
4	Overflow Exception (INTO instruction)
5	Bound-Range Exception (BOUND instruction)
6	Invalid-Opcode Exception
7	Device-Not-Available Exception
8	Double-Fault Exception
9	Coprocessor-Segment-Overrun Exception (reserved in AMD64)
10	Invalid-TSS Exception
11	Segment-Not-Present Exception
12	Stack Exception
13	General-Protection Exception
14	Page-Fault Exception
15	(Reserved)
16	x87 Floating-Point Exception
17	Alignment-Check Exception
18	Machine-Check Exception
19	SIMD Floating-Point Exception
0-255	Interrupt Instructions
Any	Hardware Maskable Interrupts

1.7 Additional System-Programming Facilities

1.7.1 Hardware Multitasking

A task is any program that the processor can execute, suspend, and later resume executing at the point of suspension. During the time a task is suspended, other tasks are allowed to execute. Each task has its own execution space, consisting of a code segment, data segments, and a stack segment for each privilege level. Tasks can also have their own virtual-memory environment managed by the page-translation mechanism. The state information defining this execution space is stored in the task-state segment (TSS) maintained for each task.

Support for hardware multitasking is provided by implementations of the AMD64 architecture when software is running in legacy mode. Hardware multitasking provides automated mechanisms for switching tasks, saving the execution state of the suspended task, and restoring the execution state of the resumed task. When hardware multitasking is used to switch tasks, the processor takes the following actions:

- The processor automatically suspends execution of the task, allowing any executing instructions to complete and save their results.
- The execution state of a task is saved in the task TSS.
- The execution state of a new task is loaded into the processor from its TSS.
- The processor begins executing the new task at the location specified in the new task TSS.

Use of hardware-multitasking features is optional in legacy mode. Generally, modern operating systems do not use the hardware-multitasking features, and instead perform task management entirely in software. Long mode does not support hardware multitasking at all.

Whether hardware multitasking is used or not, system software must create and initialize at least one task-state segment data-structure. This requirement holds for both long-mode and legacy-mode software. The single task-state segment holds critical pieces of the task execution environment and is referenced during certain control transfers.

Detailed information on hardware multitasking is available in Chapter 12, “Task Management,” along with a full description of the requirements that must be met in initializing a task-state segment when hardware multitasking is not used.

1.7.2 Machine Check

Implementations of the AMD64 architecture support the machine-check exception. This exception is useful in system applications with stringent requirements for reliability, availability, and serviceability. The exception allows specialized system-software utilities to report hardware errors that are generally severe and non-recoverable. Providing the capability to report such errors can allow complex system problems to be pinpointed rapidly.

The machine-check exception is described in Chapter 9, “Machine Check Mechanism.” Much of the error-reporting capabilities is implementation dependent. For more information, developers of machine-check error-reporting software should also refer to the BIOS writer’s guide for a specific implementation.

1.7.3 Software Debugging

A software-debugging mechanism is provided in hardware to help software developers quickly isolate programming errors. This capability can be used to debug system software and application software alike. Only privileged software can access the debugging facilities. Generally, software-debug support is provided by a privileged application program rather than by the operating system itself.

The facilities supported by the AMD64 architecture allow debugging software to perform the following:

- Set breakpoints on specific instructions within a program.
- Set breakpoints on an instruction-address match.
- Set breakpoints on a data-address match.
- Set breakpoints on specific I/O-port addresses.
- Set breakpoints to occur on task switches when hardware multitasking is used.
- Single step an application instruction-by-instruction.
- Single step only branches and interrupts.
- Record a history of branches and interrupts taken by a program.

The debugging facilities are fully described in “Software-Debug Resources” on page 327. Some processors provide additional, implementation-specific debug support. For more information, refer to the BIOS writer’s guide for the specific implementation.

1.7.4 Performance Monitoring

For many software developers, the ability to identify and eliminate performance bottlenecks from a program is nearly as important as quickly isolating programming errors. Implementations of the AMD64 architecture provide hardware performance-monitoring resources that can be used by special software applications to identify such bottlenecks. Non-privileged software can access the performance monitoring facilities, but only if privileged software grants that access.

The performance-monitoring facilities allow the counting of events, or the duration of events. Performance-analysis software can use the data to calculate the frequency of certain events, or the time spent performing specific activities. That information can be used to suggest areas for improvement and the types of optimizations that are helpful.

The performance-monitoring facilities are fully described in “Performance Optimization” on page 341. The specific events that can be monitored are generally implementation specific. For more information, refer to the BIOS writer’s guide for the specific implementation.

2 x86 and AMD64 Architecture Differences

The AMD64 architecture is designed to provide full binary compatibility with all previous AMD implementations of the x86 architecture. This chapter summarizes the new features and architectural enhancements introduced by the AMD64 architecture, and compares those features and enhancements with previous AMD x86 processors. Most of the new capabilities introduced by the AMD64 architecture are available only in long mode (64-bit mode, compatibility mode, or both). However, some of the new capabilities are also available in legacy mode, and are mentioned where appropriate.

The material throughout this chapter assumes the reader has a solid understanding of the x86 architecture. For those who are unfamiliar with the x86 architecture, please read the remainder of this volume before reading this chapter.

2.1 Operating Modes

See “Operating Modes” on page 11 for a complete description of the operating modes supported by the AMD64 architecture.

2.1.1 Long Mode

The AMD64 architecture introduces long mode and its two sub-modes: 64-bit mode and compatibility mode.

64-Bit Mode. 64-bit mode provides full support for 64-bit system software and applications. The new features introduced in support of 64-bit mode are summarized throughout this chapter. To use 64-bit mode, a 64-bit operating system and tool chain are required.

Compatibility Mode. Compatibility mode allows 64-bit operating systems to implement binary compatibility with existing 16-bit and 32-bit x86 applications. It allows these applications to run, without recompilation, under control of a 64-bit operating system in long mode. The architectural enhancements introduced by the AMD64 architecture that support compatibility mode are summarized throughout this chapter.

Unsupported Modes. Long mode does not support the following two operating modes:

- *Virtual-8086 Mode*—The virtual-8086 mode bit (EFLAGS.VM) is ignored when the processor is running in long mode. When long mode is enabled, any attempt to enable virtual-8086 mode is silently ignored. System software must leave long mode in order to use virtual-8086 mode.
- *Real Mode*—Real mode is not supported when the processor is operating in long mode because long mode requires that protected mode be enabled.

2.1.2 Legacy Mode

The AMD64 architecture supports a pure x86 legacy mode, which preserves binary compatibility not only with existing 16-bit and 32-bit applications but also with existing 16-bit and 32-bit operating

systems. *Legacy mode* supports real mode, protected mode, and virtual-8086 mode. A reset always places the processor in legacy mode (real mode), and the processor continues to run in legacy mode until system software activates long mode. New features added by the AMD64 architecture that are supported in legacy mode are summarized in this chapter.

2.1.3 System-Management Mode

The AMD64 architecture supports system-management mode (SMM). SMM can be entered from both long mode and legacy mode, and SMM can return directly to either mode. The following differences exist between the support of SMM in the AMD64 architecture and the SMM support found in previous processor generations:

- The SMRAM state-save area format is changed to hold the 64-bit processor state. This state-save area format is used regardless of whether SMM is entered from long mode or legacy mode.
- The auto-halt restart and I/O-instruction restart entries in the SMRAM state-save area are one byte instead of two bytes.
- The initial processor state upon entering SMM is expanded to reflect the 64-bit nature of the processor.
- New conditions exist that can cause a processor shutdown while exiting SMM.
- SMRAM caching considerations are modified because the legacy FLUSH# external signal (writeback, if modified, and invalidate) is not supported on implementations of the AMD64 architecture.

See Chapter 10, “System-Management Mode,” for more information on the SMM differences.

2.2 Memory Model

The AMD64 architecture provides enhancements to the legacy memory model to support very large physical-memory and virtual-memory spaces while in long mode. Some of this expanded support for physical memory is available in legacy mode.

2.2.1 Memory Addressing

Virtual-Memory Addressing. Virtual-memory support is expanded to 64 address bits in long mode. This allows up to 16 exabytes of virtual-address space to be accessed. The virtual-address space supported in legacy mode is unchanged.

Physical-Memory Addressing. Physical-memory support is expanded to 52 address bits in long mode and legacy mode. This allows up to 4 petabytes of physical memory to be accessed. The expanded physical-memory support is achieved by using paging and the page-size extensions.

Implementations can support fewer than 52 physical-address bits. The first implementation of the AMD64 architecture, for example, supports 40-bit physical addressing in both long mode and legacy mode.

Effective Addressing. The effective-address length is expanded to 64 bits in long mode. An effective-address calculation uses 64-bit base and index registers, and sign-extends 8-bit and 32-bit displacements to 64 bits. In legacy mode, effective addresses remain 32 bits long.

2.2.2 Page Translation

The AMD64 architecture defines an expanded page-translation mechanism supporting translation of a 64-bit virtual address to a 52-bit physical address. See “Long-Mode Page Translation” on page 128 for detailed information on the enhancements to page translation in the AMD64 architecture. The enhancements are summarized below.

Physical-Address Extensions (PAE). The AMD64 architecture requires physical-address extensions to be enabled (CR4.PAE=1) before long mode is entered. When PAE is enabled, all paging data-structures are 64 bits, allowing references into the full 52-bit physical-address space supported by the architecture.

Page-Size Extensions (PSE). Page-size extensions (CR4.PSE) are ignored in long mode. Long mode does not support the 4-Mbyte page size enabled by page-size extensions. Long mode does, however, support 4-Kbyte and 2-Mbyte page sizes.

Paging Data Structures. The AMD64 architecture extends the page-translation data structures in support of long mode. The extensions are:

- *Page-map level-4 (PML4)*—Long mode defines a new page-translation data structure, the PML4 table. The PML4 table sits at the top of the page-translation hierarchy and references PDP tables.
- *Page-directory pointer (PDP)*—The PDP tables in long mode are expanded from 4 entries to 512 entries each.
- *Page-directory pointer entry (PDPE)*—Previously undefined fields within the legacy-mode PDPE are defined by the AMD64 architecture.

CR3 Register. The CR3 register is expanded to 64 bits for use in long-mode page translation. When long mode is active, the CR3 register references the base address of the PML4 table. In legacy mode, the upper 32 bits of CR3 are masked by the processor to support legacy page translation. CR3 references the PDP base-address when physical-address extensions are enabled, or the page-directory table base-address when physical-address extensions are disabled.

Legacy-Mode Enhancements. Legacy-mode software can take advantage of the enhancements made to the physical-address extension (PAE) support and page-size extension (PSE) support. The four-level page translation mechanism introduced by long mode is not available to legacy-mode software.

- *PAE*—When physical-address extensions are enabled (CR4.PAE=1), the AMD64 architecture allows legacy-mode software to load up to 52-bit (maximum size) physical addresses into the PDE and PTE. **(Addresses are expanded to the maximum physical address size supported by the implementation.)**

- *PSE*—The use of page-size extensions allows legacy mode software to define 4-Mbyte pages using the 32-bit page-translation tables. When page-size extensions are enabled (CR4.PSE=1), the AMD64 architecture enhances the 4-Mbyte PDE to support 40 physical-address bits.

See “Legacy-Mode Page Translation” on page 120 for more information on these enhancements.

2.2.3 Segmentation

In long mode, the effects of segmentation depend on whether the processor is running in compatibility mode or 64-bit mode:

- In compatibility mode, segmentation functions just as it does in legacy mode, using legacy 16-bit or 32-bit protected mode semantics.
- 64-bit mode requires a flat-memory model for creating a flat 64-bit virtual-address space. Much of the segmentation capability present in legacy mode and compatibility mode is disabled when the processor is running in 64-bit mode.

The differences in the segmentation model as defined by the AMD64 architecture are summarized in the following sections. See Chapter 4, “Segmented Virtual Memory,” for a thorough description of these differences.

Descriptor-Table Registers. In long mode, the base-address portion of the descriptor-table registers (GDTR, IDTR, LDTR, and TR) are expanded to 64 bits. The full 64-bit base address can only be loaded by software when the processor is running in 64-bit mode (using the LGDT, LIDT, LLDT, and LTR instructions, respectively). However, the full 64-bit base address is *used* by a processor running in compatibility mode (in addition to 64-bit mode) when making a reference into a descriptor table.

A processor running in legacy mode can only load the low 32 bits of the base address, and the high 32 bits are ignored when references are made to the descriptor tables.

Code-Segment Descriptors. The AMD64 architecture defines a new code-segment descriptor attribute, L (long). In compatibility mode, the processor treats code-segment descriptors as it does in legacy mode, with the exception that the processor recognizes the L attribute. If a code descriptor with L=1 is loaded in compatibility mode, the processor leaves compatibility mode and enters 64-bit mode. In legacy mode, the L attribute is reserved.

The following differences exist for code-segment descriptors in 64-bit mode only:

- The CS base-address field is ignored by the processor.
- The CS limit field is ignored by the processor.
- Only the L (long), D (default size), and DPL (descriptor-privilege level) fields are used by the processor in 64-bit mode. All remaining attributes are ignored.

Data-Segment Descriptors. The following differences exist for data-segment descriptors in 64-bit mode only:

- The DS, ES, and SS descriptor base-address fields are ignored by the processor.

- The FS and GS descriptor base-address fields are expanded to 64 bits and used in effective-address calculations. The 64 bits of base address are mapped to model-specific registers (MSRs), and can only be loaded using the WRMSR instruction.
- The limit fields and attribute fields of all data-segment descriptors (DS, ES, FS, GS, and SS) are ignored by the processor.

In compatibility mode, the processor treats data-segment descriptors as it does in legacy mode. Compatibility mode ignores the high 32 bits of base address in the FS and GS segment descriptors when calculating an effective address.

System-Segment Descriptors. In 64-bit mode only, The LDT and TSS system-segment descriptor formats are expanded by 64 bits, allowing them to hold 64-bit base addresses. LLDT and LTR instructions can be used to load these descriptors into the LDTR and TR registers, respectively, from 64-bit mode.

In compatibility mode and legacy mode, the *formats* of the LDT and TSS system-segment descriptors are unchanged. Also, unlike code-segment and data-segment descriptors, system-segment descriptor limits *are checked* by the processor in long mode.

Some legacy mode LDT and TSS type-field encodings are illegal in long mode (both compatibility mode and 64-bit mode), and others are redefined to new types. See “System Descriptors” on page 88 for additional information.

Gate Descriptors. The following differences exist between gate descriptors in long mode (both compatibility mode and 64-bit mode) and in legacy mode:

- In long mode, all 32-bit gate descriptors are redefined as 64-bit gate descriptors, and are expanded to hold 64-bit offsets. The length of a gate descriptor in long mode is therefore 128 bits (16 bytes), versus the 64 bits (8 bytes) in legacy mode.
- Some type-field encodings are illegal in long mode, and others are redefined to new types. See “Gate Descriptors” on page 90 for additional information.
- The interrupt-gate and trap-gate descriptors define a new field, called the interrupt-stack table (IST) field.

2.3 Protection Checks

The AMD64 architecture makes the following changes to the protection mechanism in long mode:

- The page-protection-check mechanism is expanded in long mode to include the U/S and R/W protection bits stored in the PML4 entries and PDP entries.
- Several system-segment types and gate-descriptor types that are legal in legacy mode are illegal in long mode (compatibility mode and 64-bit mode) and fail type checks when used in long mode.
- Segment-limit checks are disabled in 64-bit mode for the CS, DS, ES, FS, GS, and SS segments. Segment-limit checks remain enabled for the LDT, GDT, IDT and TSS system segments.

All segment-limit checks are performed in compatibility mode.

- Code and data segments used in 64-bit mode are treated as both readable and writable.

See “Page-Protection Checks” on page 142 and “Segment-Protection Overview” on page 93 for detailed information on the protection-check changes.

2.4 Registers

The AMD64 architecture adds additional registers to the architecture, and in many cases expands the size of existing registers to 64 bits. The 80-bit floating-point stack registers and their overlaid 64-bit MMX™ registers are not modified by the AMD64 architecture.

2.4.1 General-Purpose Registers

In 64-bit mode, the general-purpose registers (GPRs) are 64 bits wide, and eight additional GPRs are available. The GPRs are: RAX, RBX, RCX, RDX, RDI, RSI, RBP, RSP, and the new R8–R15 registers. To access the full 64-bit operand size, or the new R8–R15 registers, an instruction must include a new REX instruction-prefix byte (see “REX Prefixes” on page 29 for a summary of this prefix).

In compatibility and legacy modes, the GPRs consist only of the eight legacy 32-bit registers. All legacy rules apply for determining operand size.

2.4.2 128-Bit Media Registers

In 64-bit mode, eight additional 128-bit XMM registers are available, XMM8–XMM15. A REX instruction prefix is used to access these registers. In compatibility and legacy modes, the XMM registers consist of the eight 128-bit legacy registers, XMM0–XMM7.

2.4.3 Flags Register

The flags register is expanded to 64 bits, and is called RFLAGS. All 64 bits can be accessed in 64-bit mode, but the upper 32 bits are reserved and always read back as zeros. Compatibility mode and legacy mode can read and write only the lower-32 bits of RFLAGS (the legacy EFLAGS).

2.4.4 Instruction Pointer

In long mode, the instruction pointer is extended to 64 bits, to support 64-bit code offsets. This 64-bit instruction pointer is called RIP.

2.4.5 Stack Pointer

In 64-bit mode, the size of the stack pointer, RSP, is always 64 bits. The stack size is not controlled by a bit in the SS descriptor, as it is in compatibility or legacy mode, nor can it be overridden by an instruction prefix. Address-size overrides are ignored for implicit stack references.

2.4.6 Control Registers

The AMD64 architecture defines several enhancements to the control registers (CR_n). In long mode, all control registers are expanded to 64 bits, although the entire 64 bits can be read and written only from 64-bit mode. A new control register, the task-priority register (CR8 or TPR) is added, and can be read and written from 64-bit mode. Last, the function of the page-enable bit (CR0.PG) is expanded. When long mode is enabled, the PG bit is used to activate and deactivate long mode.

2.4.7 Debug Registers

In long mode, all debug registers are expanded to 64 bits, although the entire 64 bits can be read and written only from 64-bit mode. Expanded register encodings for the decode registers allow up to eight new registers to be defined (DR8–DR15), although presently those registers are not supported by the AMD64 architecture.

2.4.8 Extended Feature Register (EFER)

The EFER is expanded by the AMD64 architecture to include a long-mode-enable bit (LME), and a long-mode-active bit (LMA). These new bits can be accessed from legacy mode and long mode.

2.4.9 Memory Type Range Registers (MTRRs)

The legacy MTRRs are architecturally defined as 64 bits, and can accommodate the maximum 52-bit physical address allowed by the AMD64 architecture. From both long mode and legacy mode, implementations of the AMD64 architecture reference the entire 52-bit physical-address value stored in the MTRRs. Long mode and legacy mode system software can update all 64 bits of the MTRRs to manage the expanded physical-address space.

2.4.10 Other Model-Specific Registers (MSRs)

Several other MSRs have fields holding physical addresses. Examples include the APIC-base register and top-of-memory register. Generally, any model-specific register that contains a physical address is defined architecturally to be 64 bits wide, and can accommodate the maximum physical-address size defined by the AMD64 architecture. When physical addresses are read from MSRs by the processor, the entire value is read regardless of the operating mode. In legacy implementations, the high-order MSR bits are reserved, and software must write those values with zeros. In legacy mode on AMD64 architecture implementations, software can read and write all supported high-order MSR bits.

2.5 Instruction Set

2.5.1 REX Prefixes

REX prefixes are a new family of instruction-prefix bytes used in 64-bit mode to:

- Specify the new GPRs and XMM registers.
- Specify a 64-bit operand size.

- Specify additional control registers. One additional control register, CR8, is defined in 64-bit mode.
- Specify additional debug registers (although none are currently defined).

Not all instructions require a REX prefix. The prefix is necessary only if an instruction references one of the extended registers or uses a 64-bit operand. If a REX prefix is used when it has no meaning, it is ignored.

Default 64-Bit Operand Size. In 64-bit mode, two groups of instructions have a default operand size of 64 bits and thus do not need a REX prefix for this operand size:

- Near branches.
- All instructions, except far branches, that implicitly reference the RSP. See “Instructions that Reference RSP” on page 31 for additional information.

2.5.2 Segment-Override Prefixes in 64-Bit Mode

In 64-bit mode, the DS, ES, SS, and CS segment-override prefixes have no effect. These four prefixes are no longer treated as segment-override prefixes in the context of multiple-prefix rules. Instead, they are treated as null prefixes.

The FS and GS segment-override prefixes are treated as segment-override prefixes in 64-bit mode. Use of the FS and GS prefixes cause their respective segment bases to be added to the effective address calculation. See “FS and GS Registers in 64-Bit Mode” on page 70 for additional information on using these segment registers.

2.5.3 Operands and Results

The AMD64 architecture provides support for using 64-bit operands and generating 64-bit results when operating in 64-bit mode. See “Operands” in Volume 1 for details.

Operand-Size Overrides. In 64-bit mode, the default operand size is 32 bits. A REX prefix can be used to specify a 64-bit operand size. Software uses a legacy operand-size (66h) prefix to toggle to 16-bit operand size. The REX prefix takes precedence over the legacy operand-size prefix.

Zero Extension of Results. In 64-bit mode, when performing 32-bit operations with a GPR destination, the processor zero-extends the 32-bit result into the full 64-bit destination. Both 8-bit and 16-bit operations on GPRs preserve all unwritten upper bits of the destination GPR. This is consistent with legacy 16-bit and 32-bit semantics for partial-width results.

2.5.4 Address Calculations

The AMD64 architecture modifies aspects of effective-address calculation to support 64-bit mode. These changes are summarized in the following sections. See “Memory Addressing” in Volume 1 for details.

Address-Size Overrides. In 64-bit mode, the default-address size is 64 bits. The address size can be overridden to 32 bits by using the address-size prefix (67h). 16-bit addresses are not supported in 64-bit mode. In compatibility mode and legacy mode, address-size overrides function the same as in x86 legacy architecture.

Displacements and Immediates. Generally, displacement and immediate values in 64-bit mode are not extended to 64 bits. They are still limited to 32 bits and are sign extended during effective-address calculations. In 64-bit mode, however, support is provided for some 64-bit displacement and immediate forms of the MOV instruction.

Zero Extending 16-Bit and 32-Bit Addresses. All 16-bit and 32-bit address calculations are zero-extended in long mode to form 64-bit addresses. Address calculations are first truncated to the effective-address size of the current mode (64-bit mode or compatibility mode), as overridden by any address-size prefix. The result is then zero-extended to the full 64-bit address width.

RIP-Relative Addressing. A new addressing form, RIP-relative (instruction-pointer relative) addressing, is implemented in 64-bit mode. The effective address is formed by adding the displacement to the 64-bit RIP of the next instruction.

2.5.5 Instructions that Reference RSP

With the exception of far branches, all instructions that implicitly reference the 64-bit stack pointer, RSP, default to a 64-bit operand size in 64-bit mode (see Table 2-1 for a listing). Pushes and pops of 32-bit stack values are not possible in 64-bit mode with these instructions, but they can be overridden to 16 bits.

Table 2-1. Instructions That Reference RSP

Mnemonic	Opcode (hex)	Description
ENTER	C8	Create Procedure Stack Frame
LEAVE	C9	Delete Procedure Stack Frame
POP reg/mem	8F/0	Pop Stack (register or memory)
POP reg	58-5F	Pop Stack (register)
POP FS	0F A1	Pop Stack into FS Segment Register
POP GS	0F A9	Pop Stack into GS Segment Register
POPF, POPFD, POPFQ	9D	Pop to rFLAGS Word, Doubleword, or Quadword
PUSH imm32	68	Push onto Stack (sign-extended doubleword)
PUSH imm8	6A	Push onto Stack (sign-extended byte)
PUSH reg/mem	FF/6	Push onto Stack (register or memory)
PUSH reg	50-57	Push onto Stack (register)
PUSH FS	0F A0	Push FS Segment Register onto Stack
PUSH GS	0F A8	Push GS Segment Register onto Stack
PUSHF, PUSHFD, PUSHFQ	9C	Push rFLAGS Word, Doubleword, or Quadword onto Stack

2.5.6 Branches

The AMD64 architecture expands two branching mechanisms to accommodate branches in the full 64-bit virtual-address space:

- In 64-bit mode, near-branch semantics are redefined.
- In both 64-bit and compatibility modes, a 64-bit call-gate descriptor is defined for far calls.

In addition, enhancements are made to the legacy SYSCALL and SYSRET instructions.

Near Branches. In 64-bit mode, the operand size for all near branches defaults to 64 bits (see Table 2-2 for a listing). Therefore, these instructions update the full 64-bit RIP without the need for a REX operand-size prefix. The following aspects of near branches default to 64 bits:

- Truncation of the instruction pointer.
- Size of a stack pop or stack push, resulting from a CALL or RET.
- Size of a stack-pointer increment or decrement, resulting from a CALL or RET.
- Size of operand fetched by indirect-branch operand size.

The operand size for near branches can be overridden to 16 bits in 64-bit mode.

Table 2-2. 64-Bit Mode Near Branches, Default 64-Bit Operand Size

Mnemonic	Opcode (hex)	Description
CALL	E8, FF/2	Call Procedure Near
Jcc	many	Jump Conditional Near
JMP	E9, EB, FF/4	Jump Near
LOOP	E2	Loop
LOOPcc	E0, E1	Loop Conditional
RET	C3, C2	Return From Call (near)

The address size of near branches is not forced in 64-bit mode. Such addresses are 64 bits by default, but they can be overridden to 32 bits by a prefix.

The size of the displacement field for relative branches is still limited to 32 bits.

Far Branches Through Long-Mode Call Gates. Long mode redefines the 32-bit call-gate descriptor type as a 64-bit call-gate descriptor and expands the call-gate descriptor size to hold a 64-bit offset. The long-mode call-gate descriptor allows far branches to reference any location in the supported virtual-address space. In long mode, the call-gate mechanism is changed as follows:

- In long mode, CALL and JMP instructions that reference call-gates must reference 64-bit call gates.
- A 64-bit call-gate descriptor must reference a 64-bit code-segment.

- When a control transfer is made through a 64-bit call gate, the 64-bit target address is read from the 64-bit call-gate descriptor. The base address in the target code-segment descriptor is ignored.

Stack Switching. Automatic stack switching is also modified when a control transfer occurs through a call gate in long mode:

- The target-stack pointer read from the TSS is a 64-bit RSP value.
- The SS register is loaded with a null selector. Setting the new SS selector to null allows nested control transfers in 64-bit mode to be handled properly. The SS.RPL value is updated to remain consistent with the newly loaded CPL value.
- The size of pushes onto the new stack is modified to accommodate the 64-bit RIP and RSP values.
- Automatic parameter copying is not supported in long mode.

Far Returns. In long mode, far returns can load a null SS selector from the stack under the following conditions:

- The target operating mode is 64-bit mode.
- The target $CPL < 3$.

Allowing RET to load SS with a null selector under these conditions makes it possible for the processor to unnest far CALLs (and interrupts) in long mode.

Task Gates. Control transfers through task gates are not supported in long mode.

Branches to 64-Bit Offsets. Because immediate values are generally limited to 32 bits, the only way a full 64-bit absolute RIP can be specified in 64-bit mode is with an indirect branch. For this reason, direct forms of far branches are eliminated from the instruction set in 64-bit mode.

SYSCALL and SYSRET Instructions. The AMD64 architecture expands the function of the legacy SYSCALL and SYSRET instructions in long mode. In addition, two new STAR registers, LSTAR and CSTAR, are provided to hold the 64-bit target RIP for the instructions when they are executed in long mode. The legacy STAR register is not expanded in long mode. See “SYSCALL and SYSRET” on page 150 for additional information.

SWAPGS Instruction. The AMD64 architecture provides the SWAPGS instruction as a fast method for system software to load a pointer to system data-structures. SWAPGS is valid only in 64-bit mode. An undefined-opcode exception (#UD) occurs if software attempts to execute SWAPGS in legacy mode or compatibility mode. See “SWAPGS Instruction” on page 152 for additional information.

SYSENTER and SYSEXIT Instructions. The SYSENTER and SYSEXIT instructions are invalid in long mode, and result in an invalid opcode exception (#UD) if software attempts to use them. Software should use the SYSCALL and SYSRET instructions when running in long mode. See “SYSENTER and SYSEXIT (Legacy Mode Only)” on page 152 for additional information.

2.5.7 NOP Instruction

The legacy x86 architecture commonly uses opcode 90h as a one-byte NOP. In 64-bit mode, the processor treats opcode 90h specially in order to preserve this NOP definition. This is necessary because opcode 90h is actually the XCHG EAX, EAX instruction in the legacy architecture. Without special handling in 64-bit mode, the instruction would not be a true no-operation. Therefore, in 64-bit mode the processor treats opcode 90h (the legacy XCHG EAX, EAX instruction) as a true NOP, regardless of a REX operand-size prefix.

This special handling does not apply to the two-byte ModRM form of the XCHG instruction. Unless a 64-bit operand size is specified using a REX prefix byte, using the two-byte form of XCHG to exchange a register with itself does not result in a no-operation, because the default operation size is 32 bits in 64-bit mode.

2.5.8 Single-Byte INC and DEC Instructions

In 64-bit mode, the legacy encodings for the 16 single-byte INC and DEC instructions (one for each of the eight GPRs) are used to encode the REX prefix values. The functionality of these INC and DEC instructions is still available, however, using the ModRM forms of those instructions (opcodes FF /0 and FF /1). See “Single-Byte INC and DEC Instructions in 64-Bit Mode” in Volume 3 for additional information.

2.5.9 MOVSXD Instruction

MOVSXD is a new instruction in 64-bit mode (the legacy ARPL instruction opcode, 63h, is reassigned as the MOVSXD opcode). It reads a fixed-size 32-bit source operand from a register or memory and (if a REX prefix is used with the instruction) sign-extends the value to 64 bits. MOVSXD is analogous to the MOVSB instruction, which sign-extends a byte to a word or a word to a doubleword, depending on the effective operand size. See “General-Purpose Instruction Reference” in Volume 3 for additional information.

2.5.10 Invalid Instructions

Table 2-3 lists instructions that are illegal in 64-bit mode. Table 2-4 on page 35 lists instructions that are invalid in long mode (both compatibility mode and 64-bit mode). Attempted use of these instructions causes an invalid-opcode exception (#UD) to occur.

Table 2-3. Invalid Instructions in 64-Bit Mode

Mnemonic	Opcode (hex)	Description
AAA	37	ASCII Adjust After Addition
AAD	D5	ASCII Adjust Before Division
AAM	D4	ASCII Adjust After Multiply
AAS	3F	ASCII Adjust After Subtraction
BOUND	62	Check Array Bounds

Table 2-3. Invalid Instructions in 64-Bit Mode (continued)

Mnemonic	Opcode (hex)	Description
CALL (far)	9A	Procedure Call Far (absolute)
DAA	27	Decimal Adjust after Addition
DAS	2F	Decimal Adjust after Subtraction
INTO	CE	Interrupt to Overflow Vector
JMP (far)	EA	Jump Far (absolute)
LDS	C5	Load DS Segment Register
LES	C4	Load ES Segment Register
POP DS	1F	Pop Stack into DS Segment
POP ES	07	Pop Stack into ES Segment
POP SS	17	Pop Stack into SS Segment
POPA, POPAD	61	Pop All to GPR Words or Doublewords
PUSH CS	0E	Push CS Segment Selector onto Stack
PUSH DS	1E	Push DS Segment Selector onto Stack
PUSH ES	06	Push ES Segment Selector onto Stack
PUSH SS	16	Push SS Segment Selector onto Stack
PUSHA, PUSHAD	60	Push All GPR Words or Doublewords onto Stack
Redundant Grp1 (undocumented)	82	Redundant encoding of group1 Eb,lb opcodes
SALC (undocumented)	D6	Set AL According to CF

Table 2-4. Invalid Instructions in Long Mode

Mnemonic	Opcode (hex)	Description
SYSENTER	0F 34	System Call
SYSEXIT	0F 35	System Return

Table 2-5 on page 36 lists the instructions that are no longer valid in 64-bit mode because their opcodes have been reassigned. The reassigned opcodes are used in 64-bit mode as REX instruction prefixes.

Table 2-5. Reassigned Instructions in 64-Bit Mode

Mnemonic	Opcode (hex)	Description
ARPL	63	Opcode for MOVSD instruction in 64-bit mode. In all other modes, this the Adjust Requestor Privilege Level instruction opcode.
DEC and INC	40-4F	Decrement by 1, Increment by 1. Two-byte versions of DEC and INC are still valid.

2.5.11 FXSAVE and FXRSTOR Instructions

The FXSAVE and FXRSTOR instructions are used to save and restore the entire 128-bit media, 64-bit media, and x87 instruction-set environment during a context switch. The AMD64 architecture modifies the memory format used by these instructions in order to save and restore the full 64-bit instruction and data pointers, as well as the XMM8–XMM15 registers. Selection of the 32-bit legacy format or the expanded 64-bit format is accomplished by using the corresponding operand size with the FXSAVE and FXRSTOR instructions. When 64-bit software executes an FXSAVE and FXRSTOR with a 32-bit operand size (no operand-size override) the 32-bit legacy format is used. When 64-bit software executes an FXSAVE and FXRSTOR with a 64-bit operand size, the 64-bit format is used.

If the fast-FXSAVE/FXRSTOR (FFXSR) feature is enabled in EFER, FXSAVE and FXRSTOR do not save or restore the XMM0–XMM15 registers when executed in 64-bit mode at CPL 0. The x87 environment and MXCSR are saved whether fast-FXSAVE/FXRSTOR is enabled or not. Software can use CPUID to determine whether the fast-FXSAVE/FXRSTOR feature is available (CPUID function 8000_0001h, EDX bit 25). The fast-FXSAVE/FXRSTOR feature has no effect on FXSAVE/FXRSTOR in non 64-bit mode or when CPL > 0.

2.6 Interrupts and Exceptions

When a processor is running in long mode, an interrupt or exception causes the processor to enter 64-bit mode. All long-mode interrupt handlers must be implemented as 64-bit code. The AMD64 architecture expands the legacy interrupt-processing and exception-processing mechanism to support handling of interrupts by 64-bit operating systems and applications. The changes are summarized in the following sections. See “Long-Mode Interrupt Control Transfers” on page 241 for detailed information on these changes.

2.6.1 Interrupt Descriptor Table

The long-mode interrupt-descriptor table (IDT) must contain 64-bit mode interrupt-gate or trap-gate descriptors for all interrupts or exceptions that can occur while the processor is running in long mode. Task gates cannot be used in the long-mode IDT, because control transfers through task gates are not supported in long mode. In long mode, the IDT index is formed by scaling the interrupt vector by 16. In legacy protected mode, the IDT is indexed by scaling the interrupt vector by eight.

2.6.2 Stack Frame Pushes

In legacy mode, the size of an IDT entry (16 bits or 32 bits) determines the size of interrupt-stack-frame pushes, and SS:eSP is pushed only on a CPL change. In long mode, the size of interrupt stack-frame pushes is fixed at eight bytes, because interrupts are handled in 64-bit mode. Long mode interrupts also cause SS:RSP to be pushed unconditionally, rather than pushing only on a CPL change.

2.6.3 Stack Switching

Legacy mode provides a mechanism to automatically switch stack frames in response to an interrupt. In long mode, a slightly modified version of the legacy stack-switching mechanism is implemented, and an alternative stack-switching mechanism—called the interrupt stack table (IST)—is supported.

Long-Mode Stack Switches. When stacks are switched as part of a long-mode privilege-level change resulting from an interrupt, the following occurs:

- The target-stack pointer read from the TSS is a 64-bit RSP value.
- The SS register is loaded with a null selector. Setting the new SS selector to null allows nested control transfers in 64-bit mode to be handled properly. The SS.RPL value is cleared to 0.
- The old SS and RSP are saved on the new stack.

Interrupt Stack Table. In long mode, a new interrupt stack table (IST) mechanism is available as an alternative to the modified legacy stack-switching mechanism. The IST mechanism unconditionally switches stacks when it is enabled. It can be enabled for individual interrupt vectors using a field in the IDT entry. This allows mixing interrupt vectors that use the modified legacy mechanism with vectors that use the IST mechanism. The IST pointers are stored in the long-mode TSS. The IST mechanism is only available when long mode is enabled.

2.6.4 IRET Instruction

In compatibility mode, IRET pops SS:eSP off the stack only if there is a CPL change. This allows legacy applications to run properly in compatibility mode when using the IRET instruction.

In 64-bit mode, IRET unconditionally pops SS:eSP off of the interrupt stack frame, even if the CPL does not change. This is done because the original interrupt always pushes SS:RSP. Because interrupt stack-frame pushes are always eight bytes in long mode, an IRET from a long-mode interrupt handler (64-bit code) must pop eight-byte items off the stack. This is accomplished by preceding the IRET with a 64-bit REX operand-size prefix.

In long mode, an IRET can load a null SS selector from the stack under the following conditions:

- The target operating mode is 64-bit mode.
- The target $CPL < 3$.

Allowing IRET to load SS with a null selector under these conditions makes it possible for the processor to unnest interrupts (and far CALLs) in long mode.

2.6.5 Task-Priority Register (CR8)

The AMD64 architecture allows software to define up to 15 external interrupt-priority classes. Priority classes are numbered from 1 to 15, with priority-class 1 being the lowest and priority-class 15 the highest.

A new control register (CR8) is introduced by the AMD64 architecture for managing priority classes. This register, also called the *task-priority register* (TPR), uses the four low-order bits for specifying a task priority. How external interrupts are organized into these priority classes is implementation dependent. See “External Interrupt Priorities” on page 228 for information on this feature.

2.6.6 New Exception Conditions

The AMD64 architecture defines a number of new conditions that can cause an exception to occur when the processor is running in long mode. Many of the conditions occur when software attempts to use an address that is not in canonical form. See “Vectors” on page 208 for information on the new exception conditions that can occur in long mode.

2.7 Hardware Task Switching

The legacy hardware task-switch mechanism is disabled when the processor is running in long mode. However, long mode requires system software to create data structures for a single task—the long-mode task.

- *TSS Descriptors*—A new TSS-descriptor type, the 64-bit TSS type, is defined for use in long mode. It is the only valid TSS type that can be used in long mode, and it must be loaded into the TR by executing the LTR instruction in *64-bit mode*. See “TSS Descriptor” on page 310 for additional information.
- *Task Gates*—Because the legacy task-switch mechanism is not supported in long mode, *software cannot use task gates in long mode*. Any attempt to transfer control to another task through a task gate causes a general-protection exception (#GP) to occur.
- *Task-State Segment*—A 64-bit task state segment (TSS) is defined for use in long mode. This new TSS format contains 64-bit stack pointers (RSP) for privilege levels 0–2, interrupt-stack-table (IST) pointers, and the I/O-map base address. See “64-Bit Task State Segment” on page 317 for additional information.

2.8 Long-Mode vs. Legacy-Mode Differences

Table 2-6 on page 39 summarizes several major system-programming differences between 64-bit mode and legacy protected mode. The third column indicates whether the difference also applies to compatibility mode. “Differences Between Long Mode and Legacy Mode” in Volume 3 summarizes the application-programming model differences.

Table 2-6. Differences Between Long Mode and Legacy Mode

Subject	64-Bit Mode Difference	Applies To Compatibility Mode?
x86 Modes	Real and virtual-8086 modes not supported	Yes
Task Switching	Task switching not supported	Yes
Addressing	64-bit virtual addresses	No
	4-level paging structures	Yes
	PAE must always be enabled	
Loaded Segment (Usage during memory reference)	CS, DS, ES, SS segment bases are ignored	No
	CS, DS, ES, FS, GS, SS segment limits are ignored	
	DS, ES, FS, GS attribute are ignored	
	CS, DS, ES, SS Segment prefixes are ignored	
Exception and Interrupt Handling	All pushes are 8 bytes	Yes
	IDT entries are expanded to 16 bytes	
	SS is not changed for stack switch	
	SS:RSP is pushed unconditionally	
Call Gates	All pushes are 8 bytes	Yes
	16-bit call gates are illegal	
	32-bit call gate type is redefined as 64-bit call gate and is expanded to 16 bytes	
	SS is not changed for stack switch	
System-Descriptor Registers	GDT, IDT, LDT, TR base registers expanded to 64 bits	Yes
System-Descriptor Table Entries and Pseudo-Descriptors	LGDT and LIDT use expanded 10-byte pseudo-descriptors	No
	LLDT and LTR use expanded 16-byte table entries	

3 System Resources

The operating system manages the software-execution environment and general system operation through the use of system resources. These resources consist of system registers (control registers and model-specific registers) and system-data structures (memory-management and protection tables). The system-control registers are described in detail in this chapter; many of the features they control are described elsewhere in this volume. The model-specific registers supported by the AMD64 architecture are introduced in this chapter.

Because of their complexity, system-data structures are described in separate chapters. Refer to the following chapters for detailed information on these data structures:

- Descriptors and descriptor tables are described in “Segmentation Data Structures and Registers” on page 65.
- Page-translation tables are described in “Legacy-Mode Page Translation” on page 120 and “Long-Mode Page Translation” on page 128.
- The task-state segment is described in “Legacy Task-State Segment” on page 313 and “64-Bit Task State Segment” on page 317.

Not all processor implementations are required to support all possible features. The last section in this chapter addresses processor-feature identification. System software uses the capabilities described in that section to determine which features are supported so that the appropriate service routines are loaded.

3.1 System-Control Registers

The registers that control the AMD64 architecture operating environment include:

- *CR0*—Provides operating-mode controls and some processor-feature controls.
- *CR2*—This register is used by the page-translation mechanism. It is loaded by the processor with the page-fault virtual address when a page-fault exception occurs.
- *CR3*—This register is also used by the page-translation mechanism. It contains the base address of the highest-level page-translation table, and also contains cache controls for the specified table.
- *CR4*—This register contains additional controls for various operating-mode features.
- *CR8*—This new register, accessible in 64-bit mode using the REX prefix, is introduced by the AMD64 architecture. CR8 is used to prioritize external interrupts and is referred to as the *task-priority register* (TPR).
- *RFLAGS*—This register contains processor-status and processor-control fields. The status and control fields are used primarily in the management of virtual-8086 mode, hardware multitasking, and interrupts.

- *EFER*—This model-specific register contains status and controls for additional features not managed by the CR0 and CR4 registers. Included in this register are the long-mode enable and activation controls introduced by the AMD64 architecture.

Control registers CR1, CR5–CR7, and CR9–CR15 are reserved.

In legacy mode, all control registers and RFLAGS are 32 bits. The EFER register is 64 bits in all modes. The AMD64 architecture expands all 32-bit system-control registers to 64 bits. In 64-bit mode, the MOV CR n instructions read or write all 64 bits of these registers (operand-size prefixes are ignored). In compatibility and legacy modes, control-register writes fill the low 32 bits with data and the high 32 bits with zeros, and control-register reads return only the low 32 bits.

In 64-bit mode, the high 32 bits of CR0 and CR4 are reserved and must be written with zeros. Writing a 1 to any of the high 32 bits results in a general-protection exception, #GP(0). All 64 bits of CR2 are writable. However, the MOV CR n instructions *do not* check that addresses written to CR2 are within the virtual-address limitations of the processor implementation.

All CR3 bits are writable, except for unimplemented physical address bits, which must be cleared to 0.

The upper 32 bits of RFLAGS are always read as zero by the processor. Attempts to load the upper 32 bits of RFLAGS with anything other than zero are ignored by the processor.

3.1.1 CR0 Register

The CR0 register is shown in Figure 3-1 on page 43. The legacy CR0 register is identical to the low 32 bits of the register shown in Figure 3-1 on page 43 (CR0 bits 31–0).

63										32																	
Reserved, MBZ																											
31			30		29		28		19			18		17		16		15		6		5	4	3	2	1	0
P	C	N	Reserved					A	R	W	Reserved					N	E	T	E	M	P	E					
G	D	W						M	R	P						E	T	S	M	P	E						
Bits	Mnemonic	Description																		R/W							
63–32	Reserved	Reserved, Must be Zero																									
31	PG	Paging																		R/W							
30	CD	Cache Disable																		R/W							
29	NW	Not Writethrough																		R/W							
28–19	Reserved	Reserved																									
18	AM	Alignment Mask																		R/W							
17	Reserved	Reserved																									
16	WP	Write Protect																		R/W							
15–6	Reserved	Reserved																									
5	NE	Numeric Error																		R/W							
4	ET	Extension Type																		R							
3	TS	Task Switched																		R/W							
2	EM	Emulation																		R/W							
1	MP	Monitor Coprocessor																		R/W							
0	PE	Protection Enabled																		R/W							

Figure 3-1. Control Register 0 (CR0)

The functions of the CR0 control bits are (unless otherwise noted, all bits are read/write):

Protected-Mode Enable (PE) Bit. Bit 0. Software enables protected mode by setting PE to 1, and disables protected mode by clearing PE to 0. When the processor is running in protected mode, segment-protection mechanisms are enabled.

See “Segment-Protection Overview” on page 93 for information on the segment-protection mechanisms.

Monitor Coprocessor (MP) Bit. Bit 1. Software uses the MP bit with the task-switched control bit (CR0.TS) to control whether execution of the WAIT/FWAIT instruction causes a device-not-available exception (#NM) to occur, as follows:

- If both the monitor-coprocessor and task-switched bits are set (CR0.MP=1 and CR0.TS=1), then executing the WAIT/FWAIT instruction causes a device-not-available exception (#NM).
- If either the monitor-coprocessor or task-switched bits are clear (CR0.MP=0 or CR0.TS=0), then executing the WAIT/FWAIT instruction proceeds normally.

Software typically should set MP to 1 if the processor implementation supports x87 instructions. This allows the CR0.TS bit to completely control when the x87-instruction context is saved as a result of a task switch.

Emulate Coprocessor (EM) Bit. Bit 2. Software forces all x87 instructions to cause a device-not-available exception (#NM) by setting EM to 1. Likewise, setting EM to 1 forces an invalid-opcode exception (#UD) when an attempt is made to execute any of the 64-bit or 128-bit media instructions. The exception handlers can emulate these instruction types if desired. Setting the EM bit to 1 does not cause an #NM exception when the WAIT/FWAIT instruction is executed.

Task Switched (TS) Bit. Bit 3. When an attempt is made to execute an x87 or media instruction while TS=1, a device-not-available exception (#NM) occurs. Software can use this mechanism—sometimes referred to as “lazy context-switching”—to save the unit contexts before executing the next instruction of those types. As a result, the x87 and media instruction-unit contexts are saved only when necessary as a result of a task switch.

When a hardware task switch occurs, TS is automatically set to 1. System software that implements software task-switching rather than using the hardware task-switch mechanism can still use the TS bit to control x87 and media instruction-unit context saves. In this case, the task-management software uses a MOV CR0 instruction to explicitly set the TS bit to 1 during a task switch. Software can clear the TS bit by either executing the CLTS instruction or by writing to the CR0 register directly. Long-mode system software can use this approach even though the hardware task-switch mechanism is not supported in long mode.

The CR0.MP bit controls whether the WAIT/FWAIT instruction causes an #NM exception when TS=1.

Extension Type (ET) Bit. Bit 4, read-only. In some early x86 processors, software set ET to 1 to indicate support of the 387DX math-coprocessor instruction set. This bit is now reserved and forced to 1 by the processor. Software cannot clear this bit to 0.

Numeric Error (NE) Bit. Bit 5. Clearing the NE bit to 0 disables internal control of x87 floating-point exceptions and enables external control. When NE is cleared to 0, the IGNNE# input signal controls whether x87 floating-point exceptions are ignored:

- When IGNNE# is 1, x87 floating-point exceptions are ignored.
- When IGNNE# is 0, x87 floating-point exceptions are reported by setting the FERR# input signal to 1. External logic can use the FERR# signal as an external interrupt.

When NE is set to 1, internal control over x87 floating-point exception reporting is enabled and the external reporting mechanism is disabled. It is recommended that software set NE to 1. This enables optimal performance in handling x87 floating-point exceptions.

Write Protect (WP) Bit. Bit 16. Read-only pages are protected from supervisor-level writes when the WP bit is set to 1. When WP is cleared to 0, supervisor software can write into read-only pages.

See “Page-Protection Checks” on page 142 for information on the page-protection mechanism.

Alignment Mask (AM) Bit. Bit 18. Software enables automatic alignment checking by setting the AM bit to 1 when eFLAGS.AC=1. Alignment checking can be disabled by clearing either AM or eFLAGS.AC to 0. When automatic alignment checking is enabled and CPL=3, a memory reference to an unaligned operand causes an alignment-check exception (#AC).

Not Writethrough (NW) Bit. Bit 29. Ignored. This bit can be set to 1 or cleared to 0, but its value is ignored. The NW bit exists only for legacy purposes.

Cache Disable (CD) Bit. Bit 30. When CD is cleared to 0, the internal caches are enabled. When CD is set to 1, no new data or instructions are brought into the internal caches. However, the processor still accesses the internal caches when CD=1 under the following situations:

- Reads that hit in an internal cache cause the data to be read from the internal cache that reported the hit.
- Writes that hit in an internal cache cause the cache line that reported the hit to be written back to memory and invalidated in the cache.

Cache misses do not affect the internal caches when CD=1. Software can prevent cache access by writing back and invalidating the caches before setting CD to 1 (this avoids caching the instructions that set CD to 1).

Setting CD to 1 also causes the processor to ignore the page-level cache-control bits (PWT and PCD) when paging is enabled. These bits are located in the page-translation tables and CR3 register. See “Page-Level Writethrough (PWT) Bit” on page 137 and “Page-Level Cache Disable (PCD) Bit” on page 137 for information on page-level cache control.

See “Memory Caches” on page 176 for information on the internal caches.

Paging Enable (PG) Bit. Bit 31. Software enables page translation by setting PG to 1, and disables page translation by clearing PG to 0. Page translation cannot be enabled unless the processor is in protected mode (CR0.PE=1). If software attempts to set PG to 1 when PE is cleared to 0, the processor causes a general-protection exception (#GP).

See “Page Translation Overview” on page 115 for information on the page-translation mechanism.

Reserved Bits. Bits 28–19, 17, 15–6, and 63–32. When writing the CR0 register, software should set the values of reserved bits to the values found during the previous CR0 read. No attempt should be made to change reserved bits, and software should never rely on the values of reserved bits. In long mode, bits 63–32 are reserved and must be written with zero, otherwise a #GP occurs.

3.1.2 CR2 and CR3 Registers

The CR2 (page-fault linear address) register, shown in Figure 3-2 on page 46 and Figure 3-3 on page 46, and the CR3 (page-translation-table base address) register, shown in Figure 3-4 and Figure 3-5 on page 46, and Figure 3-6 on page 46, are used only by the page-translation mechanism.

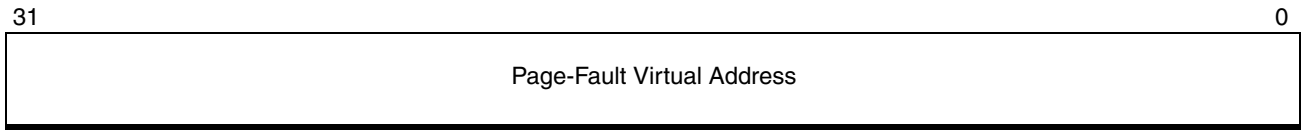

Figure 3-2. Control Register 2 (CR2)—Legacy-Mode

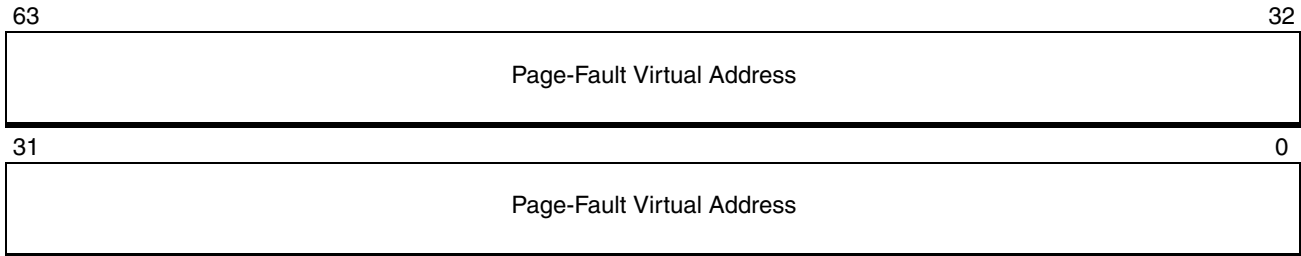

Figure 3-3. Control Register 2 (CR2)—Long Mode

See “CR2 Register” on page 220 for a description of the CR2 register.

The CR3 register is used to point to the base address of the highest-level page-translation table.



Figure 3-4. Control Register 3 (CR3)—Legacy-Mode Non-PAE Paging

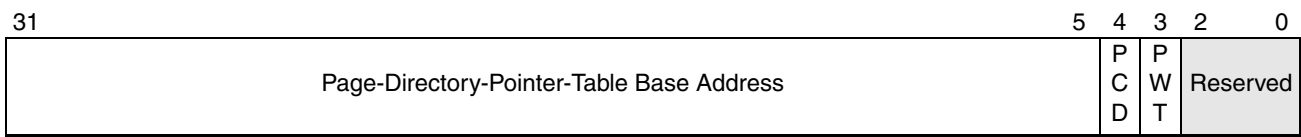

Figure 3-5. Control Register 3 (CR3)—Legacy-Mode PAE Paging

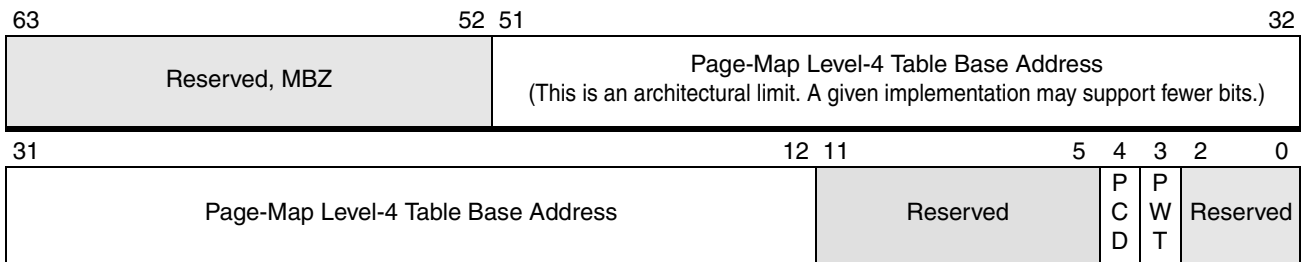

Figure 3-6. Control Register 3 (CR3)—Long Mode

The legacy CR3 register is described in “CR3 Register” on page 120, and the long-mode CR3 register is described in “CR3” on page 128.

3.1.3 CR4 Register

The CR4 register is shown in Figure 3-7. In legacy mode, the CR4 register is identical to the low 32 bits of the register (CR4 bits 31–0). The features controlled by the bits in the CR4 register are model-specific extensions. Except for the performance-counter extensions (PCE) feature, software can use the CPUID instruction to verify that each feature is supported before using that feature.

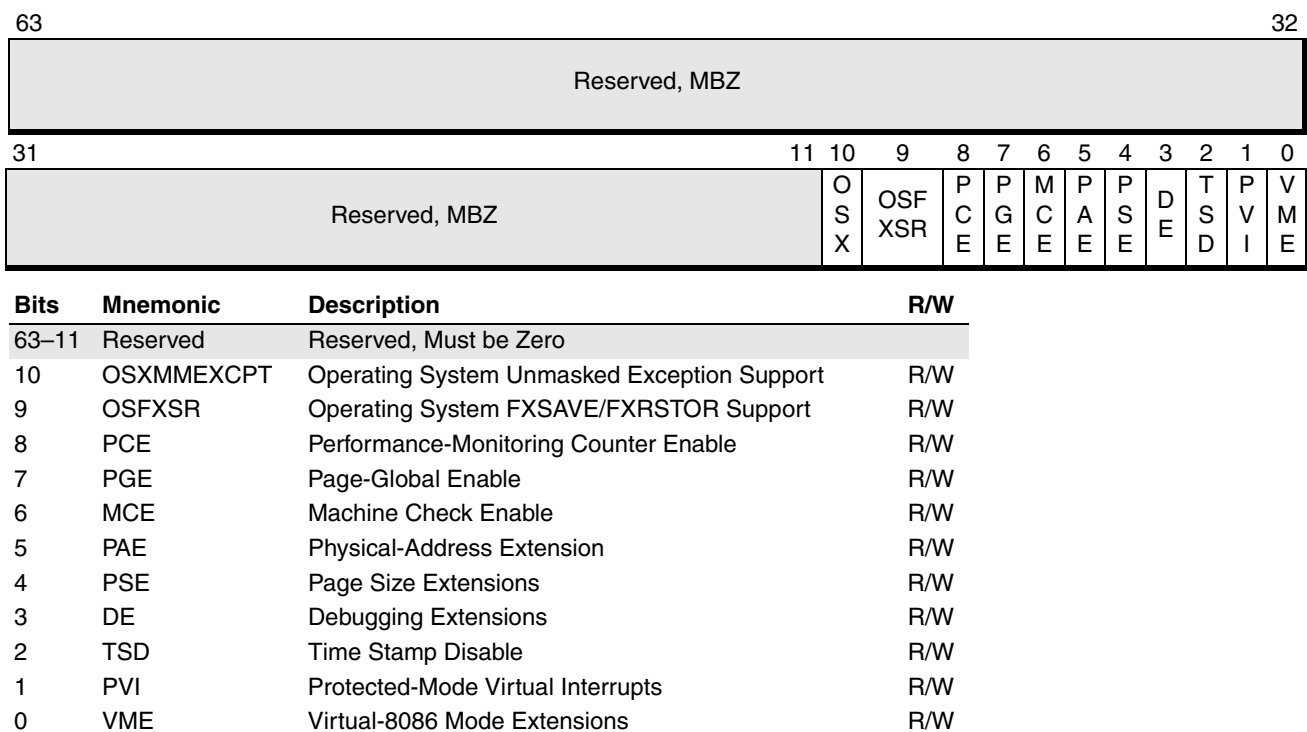

Figure 3-7. Control Register 4 (CR4)

The function of the CR4 control bits are (all bits are read/write):

Virtual-8086 Mode Extensions (VME) Bit. Bit 0. Setting VME to 1 enables hardware-supported performance enhancements for software running in virtual-8086 mode. Clearing VME to 0 disables this support. The enhancements enabled when VME=1 include:

- Virtualized, maskable, external-interrupt control and notification using the VIF and VIP bits in the rFLAGS register. Virtualizing affects the operation of several instructions that manipulate the rFLAGS.IF bit.
- Selective intercept of software interrupts (INT n instructions) using the interrupt-redirection bitmap in the TSS.

Protected-Mode Virtual Interrupts (PVI) Bit. Bit 1. Setting PVI to 1 enables support for protected-mode virtual interrupts. Clearing PVI to 0 disables this support. When PVI=1, hardware support of two bits in the rFLAGS register, VIF and VIP, is enabled.

Only the STI and CLI instructions are affected by enabling PVI. Unlike the case when CR0.VME=1, the interrupt-redirection bitmap in the TSS cannot be used for selective INT_n interception.

PVI enhancements are also supported in long mode. See “Virtual Interrupts” on page 247 for more information on using PVI.

Time-Stamp Disable (TSD) Bit. Bit 2. The TSD bit allows software to control the privilege level at which the time-stamp counter can be read. When TSD is cleared to 0, software running at any privilege level can read the time-stamp counter using the RDTSC or RDTSCP instructions. When TSD is set to 1, only software running at privilege-level 0 can execute the RDTSC or RDTSCP instructions.

Debugging Extensions (DE) Bit. Bit 3. Setting the DE bit to 1 enables the I/O breakpoint capability and enforces treatment of the DR4 and DR5 registers as reserved. Software that accesses DR4 or DR5 when DE=1 causes a invalid opcode exception (#UD).

When the DE bit is cleared to 0, I/O breakpoint capabilities are disabled. Software references to the DR4 and DR5 registers are aliased to the DR6 and DR7 registers, respectively.

Page-Size Extensions (PSE) Bit. Bit 4. Setting PSE to 1 enables the use of 4-Mbyte physical pages. With PSE=1, the physical-page size is selected between 4 Kbytes and 4 Mbytes using the page-directory entry page-size field (PS). Clearing PSE to 0 disables the use of 4-Mbyte physical pages and restricts all physical pages to 4 Kbytes.

The PSE bit has no effect when physical-address extensions are enabled (CR4.PAE=1). Because long mode requires CR4.PAE=1, the PSE bit is ignored when the processor is running in long mode.

See “4-Mbyte Page Translation” on page 123 for more information on 4-Mbyte page translation.

Physical-Address Extension (PAE) Bit. Bit 5. Setting PAE to 1 enables the use of physical-address extensions and 2-Mbyte physical pages. Clearing PAE to 0 disables these features.

With PAE=1, the page-translation data structures are expanded from 32 bits to 64 bits, allowing the translation of up to 52-bit physical addresses. Also, the physical-page size is selectable between 4 Kbytes and 2 Mbytes using the page-directory-entry page-size field (PS). Long mode requires PAE to be enabled in order to use the 64-bit page-translation data structures to translate 64-bit virtual addresses to 52-bit physical addresses.

See “PAE Paging” on page 124 for more information on physical-address extensions.

Machine-Check Enable (MCE) Bit. Bit 6. Setting MCE to 1 enables the machine-check exception mechanism. Clearing this bit to 0 disables the mechanism. When enabled, a machine-check exception (#MC) occurs when an uncorrectable machine-check error is encountered.

Regardless of whether machine-check exceptions are enabled, the processor records enabled-errors when they occur. Error-reporting is performed by the machine-check error-reporting register banks. Each bank includes a control register for enabling error reporting and a status register for capturing errors. Correctable machine-check errors are also reported, but they do not cause a machine-check exception.

See Chapter 9, “Machine Check Mechanism,” for a description of the machine-check mechanism, the registers used, and the types of errors captured by the mechanism.

Page-Global Enable (PGE) Bit. Bit 7. When page translation is enabled, system-software performance can often be improved by making some page translations *global* to all tasks and procedures. Setting PGE to 1 enables the global-page mechanism. Clearing this bit to 0 disables the mechanism.

When PGE is enabled, system software can set the global-page (G) bit in the lowest level of the page-translation hierarchy to 1, indicating that the page translation is global. Page translations marked as global are not invalidated in the TLB when the page-translation-table base address (CR3) is updated. When the G bit is cleared, the page translation is not global. All supported physical-page sizes also support the global-page mechanism. See “Global Pages” on page 140 for information on using the global-page mechanism.

Performance-Monitoring Counter Enable (PCE) Bit. Bit 8. Setting PCE to 1 allows software running at any privilege level to use the RDPMC instruction. Software uses the RDPMC instruction to read the four performance-monitoring MSRs, PerfCTR[3:0]. Clearing PCE to 0 allows only the most-privileged software (CPL=0) to use the RDPMC instruction.

FXSAVE/FXRSTOR Support (OSFXSR) Bit. Bit 9. System software must set the OSFXSR bit to 1 to enable use of the 128-bit media instructions. When this bit is set to 1, it also indicates that system software uses the FXSAVE and FXRSTOR instructions to save and restore the processor state for the x87, 64-bit media, and 128-bit media instructions.

Clearing the OSFXSR bit to 0 indicates that 128-bit media instructions cannot be used. Attempts to use those instructions while this bit is clear result in an invalid-opcode exception (#UD). Software can continue to use the FXSAVE/FXRSTOR instructions for saving and restoring the processor state for the x87 and 64-bit media instructions.

Unmasked Exception Support (OSXMMEXCPT) Bit. Bit 10. System software must set the OSXMMEXCPT bit to 1 when it supports the SIMD floating-point exception (#XF) for handling of unmasked 128-bit media floating-point errors. Clearing the OSXMMEXCPT bit to 0 indicates the #XF handler is not supported. When OSXMMEXCPT=0, unmasked 128-bit media floating-point exceptions cause an invalid-opcode exception (#UD). See “SIMD Floating-Point Exception Causes” in Volume 1 for more information on 128-bit media unmasked floating-point exceptions.

3.1.4 CR1 and CR5–CR7 Registers

Control registers CR1, CR5–CR7, and CR9–CR15 are reserved. Attempts by software to use these registers result in an undefined-opcode exception (#UD).

3.1.5 64-Bit-Mode Extended Control Registers

In 64-bit mode, additional encodings for control registers are available. The REX.R bit, in a REX prefix, is used to modify the ModRM *reg* field when that field encodes a control register, as shown in “REX Prefixes” in Volume 3. These additional encodings enable the processor to address CR8–CR15.

One additional control register, CR8, is defined in 64-bit mode for all hardware implementations, as described in “CR8 (Task Priority Register, TPR),” below. Access to the CR9–CR15 registers is implementation-dependent. Any attempt to access an unimplemented register results in an invalid-opcode exception (#UD).

3.1.6 CR8 (Task Priority Register, TPR)

The AMD64 architecture introduces a new control register, CR8, defined as the task priority register (TPR). The register is accessible in 64-bit mode using the REX prefix. See “External Interrupt Priorities” on page 228 for a description of the TPR and how system software can use the TPR for controlling external interrupts.

3.1.7 RFLAGS Register

The RFLAGS register contains two different types of information:

- *Control bits* provide system-software controls and directional information for string operations. Some of these bits can have privilege-level restrictions.
- *Status bits* provide information resulting from logical and arithmetic operations. These are written by the processor and can be read by software running at any privilege level.

Figure 3-8 on page 51 shows the format of the RFLAGS register. The legacy EFLAGS register is identical to the low 32 bits of the register shown in Figure 3-8 (RFLAGS bits 31–0). The term *rFLAGS* is used to refer to the 16-bit, 32-bit, or 64-bit flags register, depending on context.

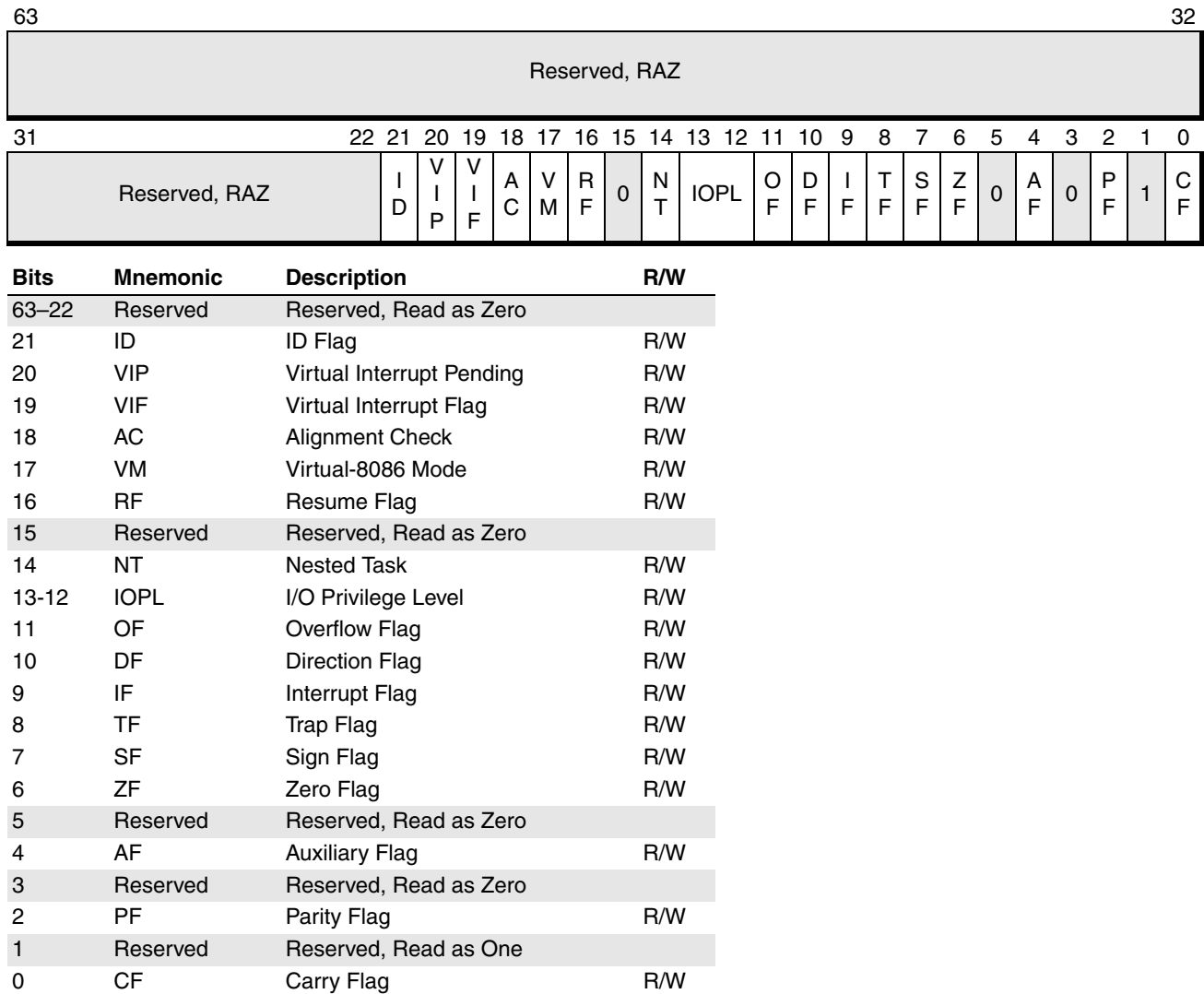

Figure 3-8. RFLAGS Register

The functions of the RFLAGS control and status bits used by application software are described in “Flags Register” in Volume 1. The functions of RFLAGS system bits are (unless otherwise noted, all bits are read/write):

Trap Flag (TF) Bit. Bit 8. Software sets the TF bit to 1 to enable single-step mode during software debug. Clearing this bit to 0 disables single-step mode.

When single-step mode is enabled, a debug exception (#DB) occurs after each instruction completes execution. Single stepping begins with the instruction *following* the instruction that sets TF. Single stepping is disabled (TF=0) when the #DB exception occurs or when any exception or interrupt occurs.

See “Single Stepping” on page 339 for information on using the single-step mode during debugging.

Interrupt Flag (IF) Bit. Bit 9. Software sets the IF bit to 1 to enable maskable interrupts. Clearing this bit to 0 causes the processor to ignore maskable interrupts. The state of the IF bit does not affect the response of a processor to non-maskable interrupts, software-interrupt instructions, or exceptions.

The ability to modify the IF bit depends on several factors:

- The current privilege-level (CPL)
- The I/O privilege level (RFLAGS.IOPL)
- Whether or not virtual-8086 mode extensions are enabled (CR4.VME=1)
- Whether or not protected-mode virtual interrupts are enabled (CR4.PVI=1)

See “Masking External Interrupts” on page 207 for information on interrupt masking. See “Accessing the RFLAGS Register” on page 154 for information on the specific instructions used to modify the IF bit.

I/O Privilege Level Field (IOPL) Field. Bits 13–12. The IOPL field specifies the privilege level required to execute I/O address-space instructions (i.e., instructions that address the I/O space rather than memory-mapped I/O, such as IN, OUT, INS, OUTS, etc.). For software to execute these instructions, the current privilege-level (CPL) must be equal to or higher than (lower numerical value than) the privilege specified by IOPL ($CPL \leq IOPL$). If the CPL is lower than (higher numerical value than) that specified by the IOPL ($CPL > IOPL$), the processor causes a general-protection exception (#GP) when software attempts to execute an I/O instruction. See “Protected-Mode I/O” in Volume 1 for information on how IOPL controls access to address-space I/O.

Virtual-8086 mode uses IOPL to control virtual interrupts and the IF bit when virtual-8086 mode extensions are enabled (CR4.VME=1). The protected-mode virtual-interrupt mechanism (PVI) also uses IOPL to control virtual interrupts and the IF bit when PVI is enabled (CR4.PVI=1). See “Virtual Interrupts” on page 247 for information on how IOPL is used by the virtual interrupt mechanism.

Nested Task (NT) Bit. Bit 14, IRET reads the NT bit to determine whether the current task is nested within another task. When NT is set to 1, the current task is nested within another task. When NT is cleared to 0, the current task is at the top level (not nested).

The processor sets the NT bit during a task switch resulting from a CALL, interrupt, or exception through a task gate. When an IRET is executed from legacy mode while the NT bit is set, a task switch occurs. See “Task Switches Using Task Gates” on page 323 for information on switching tasks using task gates, and “Nesting Tasks” on page 325 for information on task nesting.

Resume Flag (RF) Bit. Bit 16. The RF bit allows an instruction to be restarted following an instruction breakpoint resulting in a debug exception (#DB). This bit prevents multiple debug exceptions from occurring on the same instruction.

The processor clears the RF bit after every instruction is successfully executed, except when the instruction is:

- An IRET that sets the RF bit.
- JMP, CALL, or INT n through a task gate.

In both of the above cases, RF is not cleared to 0 until the *next* instruction successfully executes.

When an exception occurs (or when a string instruction is interrupted), the processor normally sets RF=1 in the rFLAGS image saved on the interrupt stack. However, when a #DB exception occurs as a result of an instruction breakpoint, the processor clears the RF bit to 0 in the interrupt-stack rFLAGS image.

For instruction restart to work properly following an instruction breakpoint, the #DB exception handler must set RF to 1 in the interrupt-stack rFLAGS image. When an IRET is later executed to return to the instruction that caused the instruction-breakpoint #DB exception, the set RF bit (RF=1) is loaded from the interrupt-stack rFLAGS image. RF is not cleared by the processor until the instruction causing the #DB exception successfully executes.

Virtual-8086 Mode (VM) Bit. Bit 17. Software sets the VM bit to 1 to enable virtual-8086 mode. Software clears the VM bit to 0 to disable virtual-8086 mode. System software can only change this bit using a task switch or an IRET. It cannot modify the bit using the POPFD instruction.

Alignment Check (AC) Bit. Bit 18. Software enables automatic alignment checking by setting the AC bit to 1 when CR0.AM=1. Alignment checking can be disabled by clearing either AC or CR0.AM to 0. When automatic alignment checking is enabled and the current privilege-level (CPL) is 3 (least privileged), a memory reference to an unaligned operand causes an alignment-check exception (#AC).

Virtual Interrupt (VIF) Bit. Bit 19. The VIF bit is a virtual image of the RFLAGS.IF bit. It is enabled when either virtual-8086 mode extensions are enabled (CR4.VME=1) or protected-mode virtual interrupts are enabled (CR4.PVI=1), and the RFLAGS.IOPL field is less than 3. When enabled, instructions that ordinarily would modify the IF bit actually modify the VIF bit with no effect on the RFLAGS.IF bit.

System software that supports virtual-8086 mode should enable the VIF bit using CR4.VME. This allows 8086 software to execute instructions that can set and clear the RFLAGS.IF bit without causing an exception. With VIF enabled in virtual-8086 mode, those instructions set and clear the VIF bit instead, giving the appearance to the 8086 software that it is modifying the RFLAGS.IF bit. System software reads the VIF bit to determine whether or not to take the action desired by the 8086 software (enabling or disabling interrupts by setting or clearing the RFLAGS.IF bit).

In long mode, the use of the VIF bit is supported when CR4.PVI=1. See “Virtual Interrupts” on page 247 for more information on virtual interrupts.

Virtual Interrupt Pending (VIP) Bit. Bit 20. The VIP bit is provided as an extension to both virtual-8086 mode and protected mode. It is used by system software to indicate that an external, maskable interrupt is pending (awaiting) execution by either a virtual-8086 mode or protected-mode interrupt-

service routine. Software must enable virtual-8086 mode extensions (CR4.VME=1) or protected-mode virtual interrupts (CR4.PVI=1) before using VIP.

VIP is normally set to 1 by a protected-mode interrupt-service routine that was entered from virtual-8086 mode as a result of an external, maskable interrupt. Before returning to the virtual-8086 mode application, the service routine sets VIP to 1 if EFLAGS.VIF=1. When the virtual-8086 mode application attempts to enable interrupts by clearing EFLAGS.VIF to 0 while VIP=1, a general-protection exception (#GP) occurs. The #GP service routine can then decide whether to allow the virtual-8086 mode service routine to handle the pending external, maskable interrupt. (EFLAGS is specifically referred to in this case because virtual-8086 mode is supported only from legacy mode.)

In long mode, the use of the VIP bit is supported when CR4.PVI=1. See “Virtual Interrupts” on page 247 for more information on virtual-8086 mode interrupts and the VIP bit.

Processor Feature Identification (ID) Bit. Bit 21. The ability of software to modify this bit indicates that the processor implementation supports the CPUID instruction. See “Processor Feature Identification” on page 61 for more information on the CPUID instruction.

3.1.8 Extended Feature Enable Register (EFER)

The extended-feature-enable register (EFER) contains control bits that enable additional processor features not controlled by the legacy control registers. The EFER is a model-specific register (MSR) with an address of C000_0080h (see “Model-Specific Registers (MSRs)” on page 56 for more information on MSRs). It can be read and written only by privileged software. Figure 3-9 on page 55 shows the format of the EFER register.

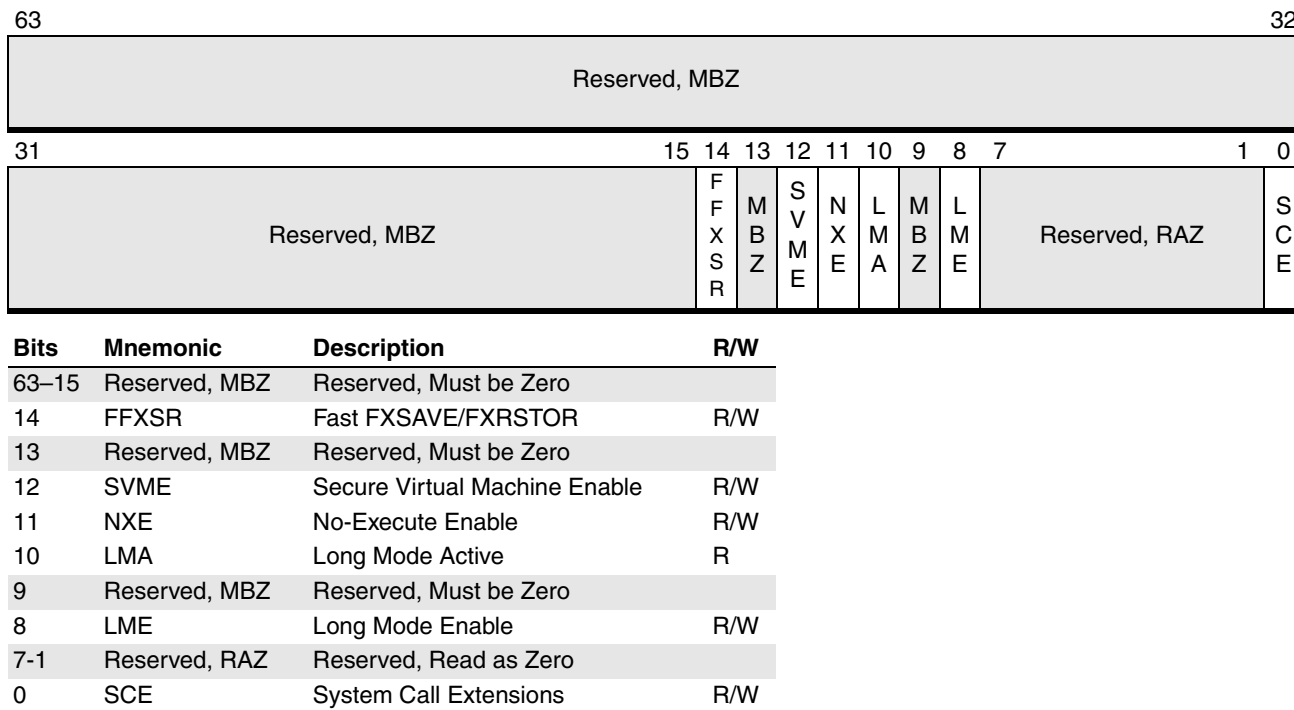

Figure 3-9. Extended Feature Enable Register (EFER)

The function of the EFER bits are (unless otherwise noted, all bits are read/write):

System-Call Extension (SCE) Bit. Bit 0. Setting this bit to 1 enables the SYSCALL and SYSRET instructions. Application software can use these instructions for low-latency system calls and returns in a non-segmented (flat) address space. See “Fast System Call and Return” on page 149 for additional information.

Long Mode Enable (LME) Bit. Bit 8. Setting this bit to 1 enables the processor to activate long mode. Long mode is not activated until software enables paging some time later. When paging is enabled after LME is set to 1, the processor sets the EFER.LMA bit to 1, indicating that long mode is not only enabled but also active. See Chapter 14, “Processor Initialization and Long Mode Activation,” for more information on activating long mode.

Long Mode Active (LMA) Bit. Bit 10, read-only. This bit indicates that long mode is active. The processor sets LMA to 1 when both long mode and paging have been enabled by system software. See Chapter 14, “Processor Initialization and Long Mode Activation,” for more information on activating long mode.

When LMA=1, the processor is running either in compatibility mode or 64-bit mode, depending on the value of the L bit in a code-segment descriptor, as shown in Figure 1-6 on page 12.

When LMA=0, the processor is running in legacy mode. In this mode, the processor behaves like a standard 32-bit x86 processor, with none of the new 64-bit features enabled.

No-Execute Enable (NXE) Bit. Bit 11. Setting this bit to 1 enables the no-execute page-protection feature. The feature is disabled when this bit is cleared to 0. See “No Execute (NX) Bit” on page 143 for more information.

Before setting NXE, system software should verify the processor supports the feature by examining the extended-feature flags returned by the CPUID instruction. For more information, see the *CPUID Specification*, order# 25481.

Secure Virtual Machine Enable (SVME) Bit. Bit 12. Enables the SVM extensions. When this bit is zero, the SVM instructions cause #UD exceptions. EFER.SVME defaults to a reset value of zero. The effect of turning off EFER.SVME while a guest is running is undefined; therefore, the VMM should always prevent guests from writing EFER. SVM extensions can be disabled by setting VM_CR.SVME_DISABLE. For more information, see descriptions of LOCK and SMVE_DISABLE bits in Section 15.28.1, “VM_CR MSR (C001_0114h),” on page 420.

Fast FXSAVE/FXRSTOR (FFXSR) Bit. Bit 14. Setting this bit to 1 enables the FXSAVE and FXRSTOR instructions to execute faster in 64-bit mode at CPL 0. This is accomplished by not saving or restoring the XMM registers (XMM0-XMM15). The FFXSR bit has no effect when the FXSAVE/FXRSTOR instructions are executed in non 64-bit mode, or when CPL > 0. The FFXSR bit does not affect the save/restore of the legacy x87 floating-point state, or the save/restore of MXCSR.

Before setting FFXSR, system software should verify whether this feature is supported by examining the CPUID extended feature flags returned by the CPUID instruction. For more information, see “Function 8000_0001h: Processor Signature and AMD Features” in Volume 3.

3.2 Model-Specific Registers (MSRs)

Processor implementations provide model-specific registers (MSRs) for software control over the unique features supported by that implementation. Software reads and writes MSRs using the privileged RDMSR and WRMSR instructions. Implementations of the AMD64 architecture can contain a mixture of two basic MSR types:

- *Legacy MSRs.* The AMD family of processors often share model-specific features with other x86 processor implementations. Where possible, AMD implementations use the same MSRs for the same functions. For example, the memory-typing and debug-extension MSRs are implemented on many AMD and non-AMD processors.
- *AMD model-specific MSRs.* There are many MSRs common to the AMD family of processors but not to legacy x86 processors. Where possible, AMD implementations use the same AMD-specific MSRs for the same functions.

Every model-specific register, as the name implies, is not necessarily implemented by all members of the AMD family of processors. Appendix A, “MSR Cross-Reference,” lists MSR-address ranges currently used by various AMD and other x86 processors.

The AMD64 architecture includes a number of features that are controlled using MSRs. Those MSRs are shown in Figure 3-10. The EFER register—described in “Extended Feature Enable Register (EFER)” on page 54—is also an MSR.

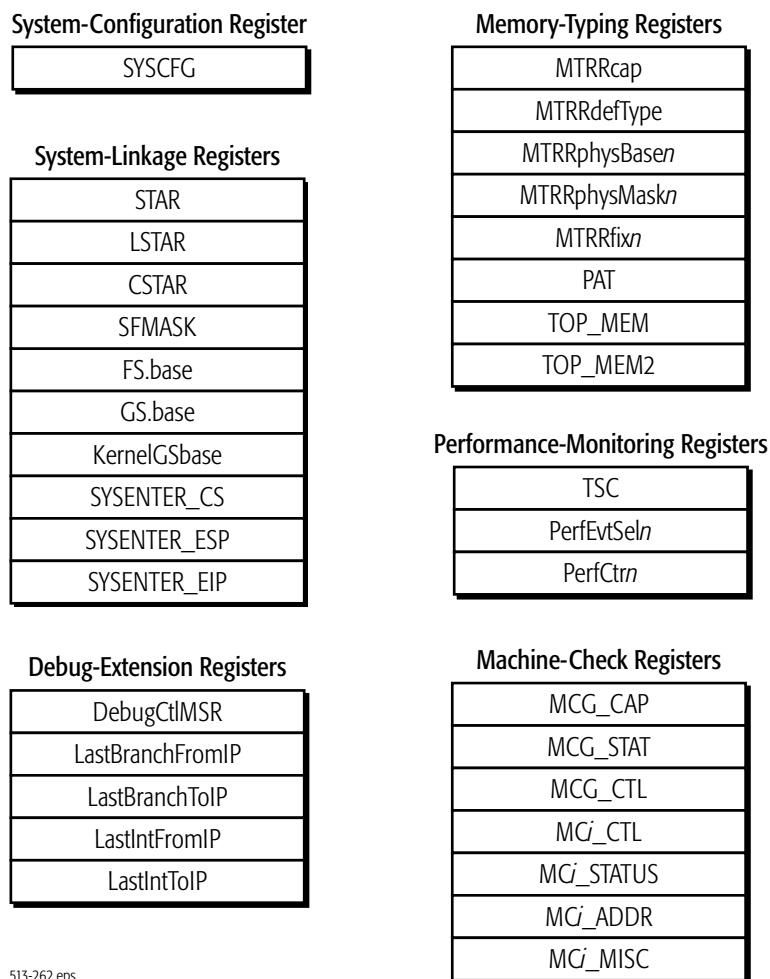

513-262.eps

Figure 3-10. AMD64 Architecture Model-Specific Registers

The following sections briefly describe the MSRs in the AMD64 architecture.

3.2.1 System Configuration Register (SYSCFG)

The system-configuration register (SYSCFG) contains control bits for enabling and configuring system bus features. SYSCFG is a model-specific register (MSR) with an address of C001_0010h. Figure 3-11 on page 58 shows the format of the SYSCFG register. Some features are implementation

specific, and are described in the BIOS writer’s guide for the implementation. Implementation-specific features are not shown in Figure 3-11.

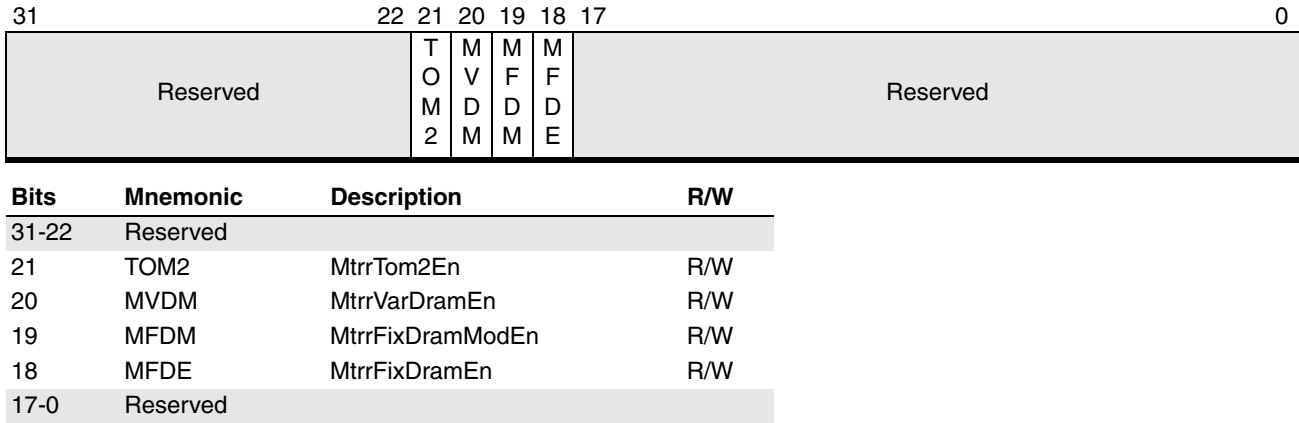

Figure 3-11. System-Configuration Register (SYSCFG)

The function of the SYSCFG bits are (all bits are read/write unless otherwise noted):

MtrrFixDramEn Bit. Bit 18. Setting this bit to 1 enables use of the RdMem and WrMem attributes in the fixed-range MTRR registers. When cleared, these attributes are disabled. The RdMem and WrMem attributes allow system software to define fixed-range IORRs using the fixed-range MTRRs. See “Extended Fixed-Range MTRR Type-Field Encodings” on page 197 for information on using this feature.

MtrrFixDramModEn Bit. Bit 19. Setting this bit to 1 allows software to read and write the RdMem and WrMem bits. When cleared, writes do not modify the RdMem and WrMem bits, and reads return 0. See “Extended Fixed-Range MTRR Type-Field Encodings” on page 197 for information on using this feature.

MtrrVarDramEn Bit. Bit 20. Setting this bit to 1 enables the TOP_MEM register and the variable-range IORRs. These registers are disabled when the bit is cleared to 0. See “IORRs” on page 199 and “Top of Memory” on page 201 for information on using these features.

MtrrTom2En Bit. Bit 21. Setting this bit to 1 enables the TOP_MEM2 register. The register is disabled when this bit is cleared to 0. See “Top of Memory” on page 201 for information on using this feature.

3.2.2 System-Linkage Registers

System-linkage MSR are used by system software to allow fast control transfers between applications and the operating system. The functions of these registers are:

STAR, LSTAR, CSTAR, and SFMASK Registers. These registers are used to provide mode-dependent linkage information for the SYSCALL and SYSRET instructions. STAR is used in legacy modes, LSTAR in 64-bit mode, and CSTAR in compatibility mode. SFMASK is used by the SYSCALL instruction for rFLAGS in long mode.

FS.base and GS.base Registers. These registers allow 64-bit base-address values to be specified for the FS and GS segments, for use in 64-bit mode. See “FS and GS Registers in 64-Bit Mode” on page 70 for a description of the special treatment the FS and GS segments receive.

KernelGSbase Register. This register is used by the SWAPGS instruction. This instruction exchanges the value located in KernelGSbase with the value located in GS.base.

SYSENTERx Registers. The SYSENTER_CS, SYSENTER_ESP, and SYSENTER_EIP registers are used to provide linkage information for the SYSENTER and SYSEXIT instructions. These instructions are only used in legacy mode.

The system-linkage instructions and their use of MSRs are described in “Fast System Call and Return” on page 149.

3.2.3 Memory-Typing Registers

Memory-typing MSRs are used to characterize, or type, memory. Memory typing allows software to control the cacheability of memory, and determine how accesses to memory are ordered. The memory-typing registers perform the following functions:

MTRRcap Register. This register contains information describing the level of MTRR support provided by the processor.

MTRRdefType Register. This register establishes the default memory type to be used for physical memory that is not specifically characterized using the fixed-range and variable-range MTRRs.

MTRRphysBasen and MTRRphysMaskn Registers. These registers form a register pair that can be used to characterize any address range within the physical-memory space, including all of physical memory. Up to eight address ranges of varying sizes can be characterized using these registers.

MTRRfixn Registers. These registers are used to characterize fixed-size memory ranges in the first 1 Mbytes of physical-memory space.

PAT Register. This register allows memory-type characterization based on the virtual (linear) address. It is an extension to the PCD and PWT memory types supported by the legacy paging mechanism. The PAT mechanism provides the same memory-typing capabilities as the MTRRs, but with the added flexibility provided by the paging mechanism.

TOP_MEM and TOP_MEM2 Registers. These top-of-memory registers allow system software to specify physical addresses ranges as memory-mapped I/O locations.

Refer to “Memory-Type Range Registers” on page 183 for more information on using these registers.

3.2.4 Debug-Extension Registers

The debug-extension MSRs provide software-debug capability not available in the legacy debug registers (DR0–DR7). These MSRs allow single stepping and recording of control transfers to take place. The debug-extension registers perform the following functions:

DebugCtlMSR Register. This register provides control over control-transfer recording and single stepping, and external-breakpoint reporting and trace messages.

LastBranchx and LastExceptionx Registers. The four registers, LastBranchToIP, LastBranchFromIP, LastExceptionToIP, and LastExceptionFromIP, are all used to record the source and target of control transfers when branch recording is enabled.

Refer to “Control-Transfer Breakpoint Features” on page 340 for more information on using these debug registers.

3.2.5 Performance-Monitoring Registers

The time-stamp counter and performance-monitoring registers are useful in identifying performance bottlenecks. There can be any number of performance counters, each numbered from 0 to n . These registers perform the following functions:

TSC Register. This register is used to count processor-clock cycles. It can be read using the RDMSR instruction, or it can be read using either of the *read time-stamp counter* instructions, RDTSC or RDTSCP. System software can make RDTSC or RDTSCP available for use by non-privileged software by clearing the time-stamp disable bit (CR4.TSD) to 0.

PerfEvtSel n Registers. These registers are used to specify the events counted by the corresponding performance counter, and to control other aspects of its operation.

PerfCtr n Registers. These registers are performance counters that hold a count of processor events or the duration of events, under the control of the corresponding PerfEvtSel n register. Each PerfCtr n register can be read using the RDMSR instruction, or they can be read using the *read performance-monitor counter* instruction, RDPMC. System software can make RDPMC available for use by non-privileged software by setting the performance-monitor counter enable bit (CR4.PCE) to 1.

Refer to “Using Performance Counters” on page 346 for more information on using these registers.

3.2.6 Machine-Check Registers

The machine-check registers control the detection and reporting of hardware machine-check errors. The types of errors that can be reported include cache-access errors, load-data and store-data errors, bus-parity errors, and ECC errors. Two types of machine-check MSRs are shown in Figure 3-10 on page 57.

The first type is global machine-check registers, which perform the following functions:

MCG_CAP Register. This register identifies the machine-check capabilities supported by the processor.

MCG_CTL Register. This register provides global control over machine-check-error reporting.

MCG_STATUS Register. This register reports global status on detected machine-check errors.

The second type is error-reporting register banks, which report on machine-check errors associated with a specific processor unit (or group of processor units). There can be different numbers of register banks for each processor implementation, and each bank is numbered from 0 to i . The registers in each bank perform the following functions:

MC i _CTL Registers. These registers control error-reporting.

MC i _STATUS Registers. These registers report machine-check errors.

MC i _ADDR Registers. These registers report the machine-check error address.

MC i _MISC Registers. These registers report miscellaneous-error information.

Refer to “Using Machine Check Features” on page 267 for more information on using these registers.

3.3 Processor Feature Identification

The CPUID instruction provides information about the processor implementation and its capabilities. Software operating at any privilege level can execute the CPUID instruction to collect this information. After the information is collected, software can be tuned to optimize performance and benefit to users. For example, game software can identify and enable the media capabilities of a particular processor implementation.

The CPUID instruction supports multiple functions, each providing different information about the processor implementation, including the vendor, model number, revision (stepping), features, cache organization, and name. The multifunction approach allows the CPUID instruction to return a detailed picture of the processor implementation and its capabilities—more detailed information than could be returned by a single function. This flexibility also allows for the addition of new CPUID functions in future processor generations.

Function codes are loaded into the EAX register before executing the CPUID instruction. CPUID functions are divided into two types:

- *Standard functions* return information about features common to all x86 implementations, including the earliest features offered in the x86 architecture, as well as information about the presence of newer features such as SSE, SSE2, and SSE3 instructions.
- *Extended functions* return information about AMD-specific features, such as the AMD extensions to the MMX™ and 3DNow!™ instructions, and long mode.

See “CPUID” in Volume 3 for details on the operation of this instruction, and the *CPUID Specification* (order# 25481) for information returned by each processor implementation.

4 Segmented Virtual Memory

The legacy x86 architecture supports a segment-translation mechanism that allows system software to relocate and isolate instructions and data anywhere in the virtual-memory space. A segment is a contiguous block of memory within the linear address space. The size and location of a segment within the linear address space is arbitrary. Instructions and data can be assigned to one or more memory segments, each with its own protection characteristics. The processor hardware enforces the rules dictating whether one segment can access another segment.

The segmentation mechanism provides ten segment registers, each of which defines a single segment. Six of these registers (CS, DS, ES, FS, GS, and SS) define user segments. User segments hold software, data, and the stack and can be used by both application software and system software. The remaining four segment registers (GDT, LDT, IDT, and TR) define system segments. System segments contain data structures initialized and used only by system software. Segment registers contain a *base address* pointing to the starting location of a segment, a *limit* defining the segment size, and *attributes* defining the segment-protection characteristics.

Although segmentation provides a great deal of flexibility in relocating and protecting software and data, it is often more efficient to handle memory isolation and relocation with a combination of software and hardware paging support. For this reason, most modern system software bypasses the segmentation features. However, segmentation cannot be completely disabled, and an understanding of the segmentation mechanism is important to implementing long-mode system software.

In long mode, the effects of segmentation depend on whether the processor is running in compatibility mode or 64-bit mode:

- In compatibility mode, segmentation functions just as it does in legacy mode, using legacy 16-bit or 32-bit protected mode semantics.
- 64-bit mode, segmentation is disabled, creating a flat 64-bit virtual-address space. As will be seen, certain functions of some segment registers, particularly the system-segment registers, continue to be used in 64-bit mode.

4.1 Real Mode Segmentation

After reset or power-up, the processor always initially enters real mode. Protected modes are entered from real mode.

As noted in “Real Addressing” on page 10, real mode (real-address mode), provides a physical-memory space of 1 Mbyte. In this mode, a 20-bit physical address is determined by shifting a 16-bit segment selector to the left four bits and adding the 16-bit effective address.

Each 64K segment (CS, DS, ES, FS, GS, SS) is aligned on 16-byte boundaries. The *segment base* is the lowest address in a given segment, and is equal to the segment selector * 16. The POP and MOV instructions can be used to load a (possibly) new segment selector into one of the segment registers.

When this occurs, the selector is updated and the selector base is set to selector * 16. The segment limit and segment attributes are unchanged, but are normally 64K (the maximum allowable limit) and read/write data, respectively.

On FAR transfers, CS (code segment) selector is updated to the new value, and the CS segment base is set to selector * 16. The CS segment limit and attributes are unchanged, but are usually 64K and read/write, respectively.

If the interrupt descriptor table (IDT) is used to find the real mode IDT see “Real-Mode Interrupt Control Transfers” on page 229.

The GDT, LDT, and TSS (see below) are not used in real mode.

4.2 Virtual-8086 Mode Segmentation

Virtual-8086 mode supports 16-bit real mode programs running under protected mode (see below). It uses a simple form of memory segmentation, optional paging, and limited protection checking. Programs running in virtual-8086 mode can access up to 1MB of memory space.

As with real mode segmentation, each 64K segment (CS, DS, ES, FS, GS, SS) is aligned on 16-byte boundaries. The *segment base* is the lowest address in a given segment, and is equal to the segment selector * 16. The POP and MOV instructions work exactly as in real mode and can be used to load a (possibly) new segment selector into one of the segment registers. When this occurs, the selector is updated and the selector base is set to selector * 16. The segment limit and segment attributes are unchanged, but are normally 64K (the maximum allowable limit) and read/write data, respectively.

FAR transfers, with the exception of interrupts and exceptions, operate as in real mode. On FAR transfers, the CS (code segment) selector is updated to the new value, and the CS segment base is set to selector * 16. The CS segment limit and attributes are unchanged, but are usually 64K and read/write, respectively. Interrupts and exceptions switch the processor to protected mode. (See Chapter 8, “Exceptions and Interrupts” for more information.)

4.3 Protected Mode Segmented-Memory Models

System software can use the segmentation mechanism to support one of two basic segmented-memory models: a flat-memory model or a multi-segmented model. These segmentation models are supported in legacy mode and in compatibility mode. Each type of model is described in the following sections.

4.3.1 Multi-Segmented Model

In the multi-segmented memory model, each segment register can reference a unique base address with a unique segment size. Segments can be as small as a single byte or as large as 4 Gbytes. When page translation is used, multiple segments can be mapped to a single page and multiple pages can be mapped to a single segment. Figure 1-1 on page 6 shows an example of the multi-segmented model.

The multi-segmented memory model provides the greatest level of flexibility for system software using the segmentation mechanism.

Compatibility mode allows the multi-segmented model to be used in support of legacy software. However, in compatibility mode, the multi-segmented memory model is restricted to the first 4 Gbytes of virtual-memory space. Access to virtual memory above 4 Gbytes requires the use of 64-bit mode, which does not support segmentation.

4.3.2 Flat-Memory Model

The flat-memory model is the simplest form of segmentation to implement. Although segmentation cannot be disabled, the flat-memory model allows system software to bypass most of the segmentation mechanism. In the flat-memory model, all segment-base addresses have a value of 0 and the segment limits are fixed at 4 Gbytes. Clearing the segment-base value to 0 effectively disables segment translation, resulting in a single segment spanning the entire virtual-address space. All segment descriptors reference this single, flat segment. Figure 1-2 on page 7 shows an example of the flat-memory model.

4.3.3 Segmentation in 64-Bit Mode

In 64-bit mode, segmentation is disabled. The segment-base value is ignored and treated as 0 by the segmentation hardware. Likewise, segment limits and most attributes are ignored. There are a few exceptions. The CS-segment DPL, D, and L attributes are used (respectively) to establish the privilege level for a program, the default operand size, and whether the program is running in 64-bit mode or compatibility mode. The FS and GS segments can be used as additional base registers in address calculations, and those segments can have non-zero base-address values. This facilitates addressing thread-local data and certain system-software data structures. See “FS and GS Registers in 64-Bit Mode” on page 70 for details about the FS and GS segments in 64-bit mode. The system-segment registers are always used in 64-bit mode.

4.4 Segmentation Data Structures and Registers

Figure 4-1 on page 66 shows the following data structures used by the segmentation mechanism:

- *Segment Descriptors*—As the name implies, a segment descriptor *describes* a segment, including its location in virtual-address space, its size, protection characteristics, and other attributes.
- *Descriptor Tables*—Segment descriptors are stored in memory in one of three tables. The global-descriptor table (GDT) holds segment descriptors that can be shared among all tasks. Multiple local-descriptor tables (LDT) can be defined to hold descriptors that are used by specific tasks and are not shared globally. The interrupt-descriptor table (IDT) holds gate descriptors that are used to access the segments where interrupt handlers are located.
- *Task-State Segment*—A task-state segment (TSS) is a special type of system segment that contains task-state information and data structures for each task. For example, a TSS holds a copy of the GPRs and EFLAGS register when a task is suspended. A TSS also holds the pointers to privileged-

software stacks. The TSS and task-switch mechanism are described in Chapter 12, “Task Management.”

- *Segment Selectors*—Descriptors are selected for use from the descriptor tables using a segment selector. A segment selector contains an index into either the GDT or LDT. The IDT is indexed using an interrupt vector, as described in “Legacy Protected-Mode Interrupt Control Transfers” on page 231, and in “Long-Mode Interrupt Control Transfers” on page 241.

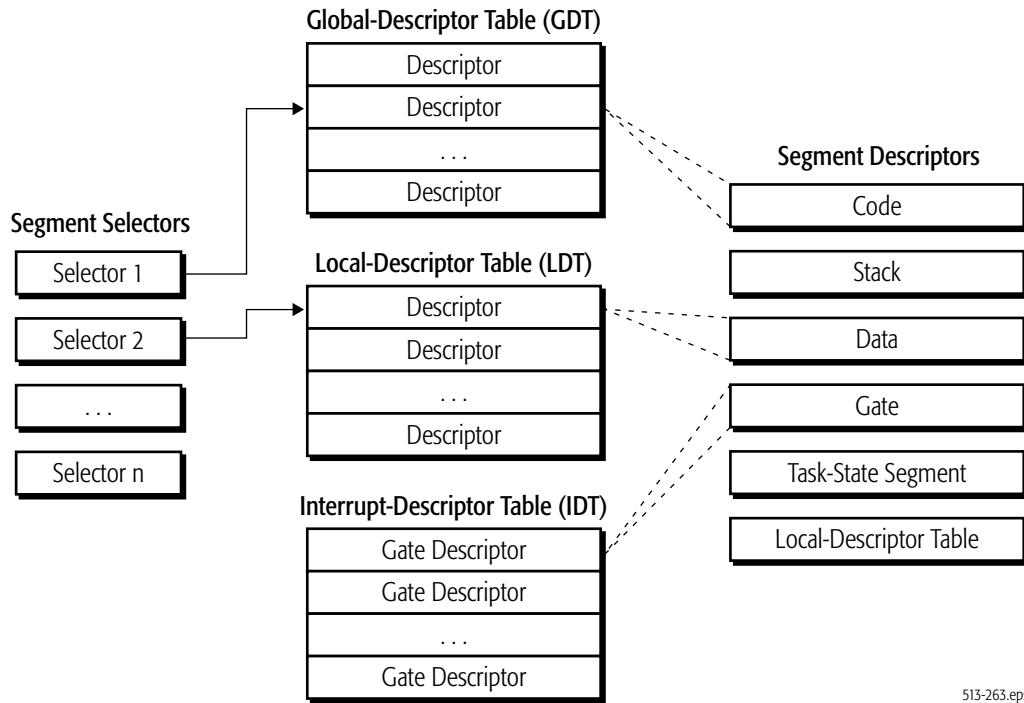

Figure 4-1. Segmentation Data Structures

Figure 4-2 on page 67 shows the registers used by the segmentation mechanism. The registers have the following relationship to the data structures:

- *Segment Registers*—The six segment registers (CS, DS, ES, FS, GS, and SS) are used to point to the user segments. A segment selector selects a descriptor when it is loaded into one of the segment registers. This causes the processor to automatically load the selected descriptor into a software-invisible portion of the segment register.
- *Descriptor-Table Registers*—The three descriptor-table registers (GDTR, LDTR, and IDTR) are used to point to the system segments. The descriptor-table registers identify the virtual-memory location and size of the descriptor tables.
- *Task Register (TR)*—Describes the location and limit of the current task state segment (TSS).

The selector format consists of the following fields:

Selector Index Field. Bits 15–3. The selector-index field specifies an entry in the descriptor table. Descriptor-table entries are eight bytes long, so the selector index is scaled by 8 to form a byte offset into the descriptor table. The offset is then added to either the global or local descriptor-table base address (as indicated by the table-index bit) to form the descriptor-entry address in virtual-address space.

Some descriptor entries in long mode are 16 bytes long rather than 8 bytes (see “Legacy Segment Descriptors” on page 77 for more information on long-mode descriptor-table entries). These expanded descriptors consume two entries in the descriptor table. Long mode, however, continues to scale the selector index by eight to form the descriptor-table offset. It is the responsibility of system software to assign selectors such that they correctly point to the start of an expanded entry.

Table Indicator (TI) Bit. Bit 2. The TI bit indicates which table holds the descriptor referenced by the selector index. When TI=0 the GDT is used and when TI=1 the LDT is used. The descriptor-table base address is read from the appropriate descriptor-table register and added to the scaled selector index as described above.

Requestor Privilege-Level (RPL) Field. Bits 1–0. The RPL represents the privilege level (CPL) the processor is operating under at the time the selector is created.

RPL is used in segment privilege-checks to prevent software running at lesser privilege levels from accessing privileged data. See “Data-Access Privilege Checks” on page 95 and “Control-Transfer Privilege Checks” on page 98 for more information on segment privilege-checks.

Null Selector. Null selectors have a selector index of 0 and TI=0, corresponding to the first entry in the GDT. However, null selectors do not reference the first GDT entry but are instead used to invalidate unused segment registers. A general-protection exception (#GP) occurs if a reference is made to use a segment register containing a null selector in non-64-bit mode. By initializing unused segment registers with null selectors software can trap references to unused segments.

Null selectors can only be loaded into the DS, ES, FS and GS data-segment registers, and into the LDTR descriptor-table register. A #GP occurs if software attempts to load the CS register with a null selector or if software attempts to load the SS register with a null selector in non 64-bit mode or at CPL 3.

4.5.2 Segment Registers

Six 16-bit segment registers are provided for referencing up to six segments at one time. All software tasks require segment selectors to be loaded in the CS and SS registers. Use of the DS, ES, FS, and GS segments is optional, but nearly all software accesses data and therefore requires a selector in the DS register. Table 4-1 on page 69 lists the supported segment registers and their functions.

Table 4-1. Segment Registers

Segment Register	Segment Register Function
CS	References code-segment descriptor entry
DS	References default data-segment descriptor entry
ES	References optional data-segment descriptor entry
FS	References optional data-segment descriptor entry
GS	References optional data-segment descriptor entry
SS	References stack segment descriptor entry

The processor maintains a *hidden portion* of the segment register in addition to the selector value loaded by software. This hidden portion contains the values found in the descriptor-table entry referenced by the segment selector. The processor loads the descriptor-table entry into the hidden portion when the segment register is loaded. By keeping the corresponding descriptor-table entry in hardware, performance is optimized for the majority of memory references.

Figure 4-4 shows the format of the visible and hidden portions of the segment register. Except for the FS and GS segment base, software cannot directly read or write the hidden portion (shown as gray-shaded boxes in Figure 4-4).

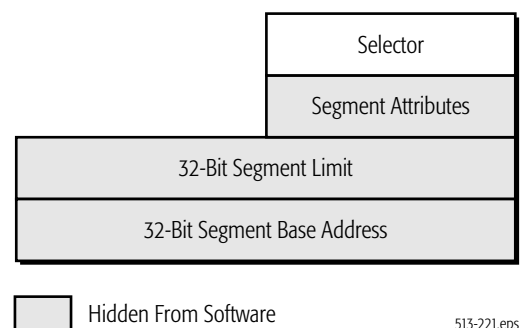
**Figure 4-4. Segment-Register Format**

CS Register. The CS register contains the segment selector referencing the current code-segment descriptor entry. All instruction fetches reference the CS descriptor. When a new selector is loaded into the CS register, the current-privilege level (CPL) of the processor is set to that of the CS-segment descriptor-privilege level (DPL).

Data-Segment Registers. The DS register contains the segment selector referencing the default data-segment descriptor entry. The SS register contains the stack-segment selector. The ES, FS, and GS registers are optionally loaded with segment selectors referencing other data segments. Data accesses default to referencing the DS descriptor except in the following two cases:

- The ES descriptor is referenced for string-instruction destinations.
- The SS descriptor is referenced for stack operations.

4.5.3 Segment Registers in 64-Bit Mode

CS Register in 64-Bit Mode. In 64-bit mode, most of the hidden portion of the CS register is ignored. Only the L (long), D (default operation size), and DPL (descriptor privilege-level) attributes are recognized by 64-bit mode. Address calculations assume a CS.base value of 0. CS references do not check the CS.limit value, but instead check that the effective address is in canonical form.

DS, ES, and SS Registers in 64-Bit Mode. In 64-bit mode, the contents of the ES, DS, and SS segment registers are ignored. All fields (base, limit, and attribute) in the hidden portion of the segment registers are ignored.

Address calculations in 64-bit mode that reference the ES, DS, or SS segments are treated as if the segment base is 0. Instead of performing limit checks, the processor checks that all virtual-address references are in canonical form.

Neither enabling and activating long mode nor switching between 64-bit and compatibility modes changes the contents of the visible or hidden portions of the segment registers. These registers remain unchanged during 64-bit mode execution unless explicit segment loads are performed.

FS and GS Registers in 64-Bit Mode. Unlike the CS, DS, ES, and SS segments, the FS and GS segment overrides can be used in 64-bit mode. When FS and GS segment overrides are used in 64-bit mode, their respective base addresses are used in the effective-address (EA) calculation. The complete EA calculation then becomes (FS or GS).base + base + (scale * index) + displacement. The FS.base and GS.base values are also expanded to the full 64-bit virtual-address size, as shown in Figure 4-5. The resulting EA calculation is allowed to wrap across positive and negative addresses.

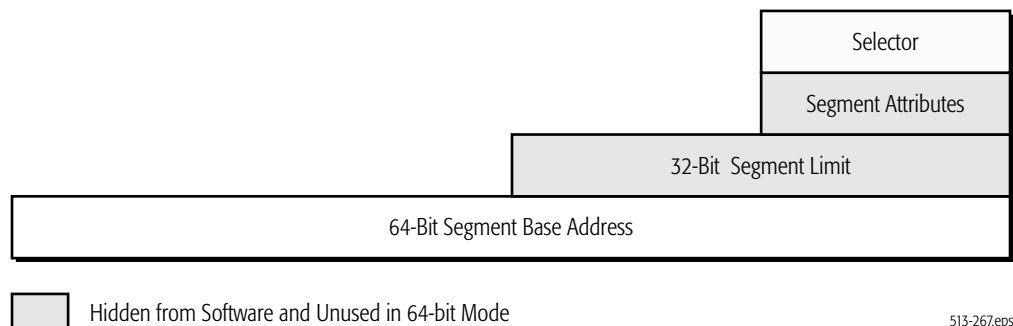

Figure 4-5. FS and GS Segment-Register Format—64-Bit Mode

In 64-bit mode, FS-segment and GS-segment overrides are not checked for limit or attributes. Instead, the processor checks that all virtual-address references are in canonical form.

Segment register-load instructions (MOV to Sreg and POP Sreg) load only a 32-bit base-address value into the hidden portion of the FS and GS segment registers. The base-address bits above the low 32 bits are cleared to 0 as a result of a segment-register load.

To allow loading all 64 bits of the base address, the FS.base and GS.base hidden descriptor-register fields are mapped to MSRs. Privileged software (CPL=0) can load the 64-bit base address into FS.base or GS.base using a single WRMSR instruction. The addresses written into the expanded FS.base and GS.base registers must be in canonical form. A WRMSR instruction that attempts to write a non-canonical address to these registers causes a general-protection exception (#GP) to occur.

The FS.base MSR address is C000_0100h while the GS.base MSR address is C000_0101h.

When in compatibility mode, the FS and GS overrides operate as defined by the legacy x86 architecture regardless of the value loaded into the high 32 bits of the hidden descriptor-register base-address field. Compatibility mode ignores the high 32 bits when calculating an effective address.

4.6 Descriptor Tables

Descriptor tables are used by the segmentation mechanism when protected mode is enabled (CR0.PE=1). These tables hold descriptor entries that describe the location, size, and privilege attributes of a segment. All memory references in protected mode access a descriptor-table entry.

As previously mentioned, there are three types of descriptor tables supported by the x86 segmentation mechanism:

- Global descriptor table (GDT)
- Local descriptor table (LDT)
- Interrupt descriptor table (IDT)

Software establishes the location of a descriptor table in memory by initializing its corresponding descriptor-table register. The descriptor-table registers and the descriptor tables are described in the following sections.

4.6.1 Global Descriptor Table

Protected-mode system software must create a global descriptor table (GDT). The GDT contains code-segment and data-segment descriptor entries (user segments) for segments that can be shared by all tasks. In addition to the user segments, the GDT can also hold gate descriptors and other system-segment descriptors. System software can store the GDT anywhere in memory and should protect the segment containing the GDT from non-privileged software.

Segment selectors point to the GDT when the table-index (TI) bit in the selector is cleared to 0. The selector index portion of the segment selector references a specific entry in the GDT. Figure 4-6 on page 72 shows how the segment selector indexes into the GDT. One special form of a segment selector is the *null selector*. A null selector points to the first entry in the GDT (the selector index is 0 and TI=0). However, null selectors do not reference memory, so the first GDT entry cannot be used to

describe a segment (see “Null Selector” on page 68 for information on using the null selector). The first usable GDT entry is referenced with a selector index of 1.

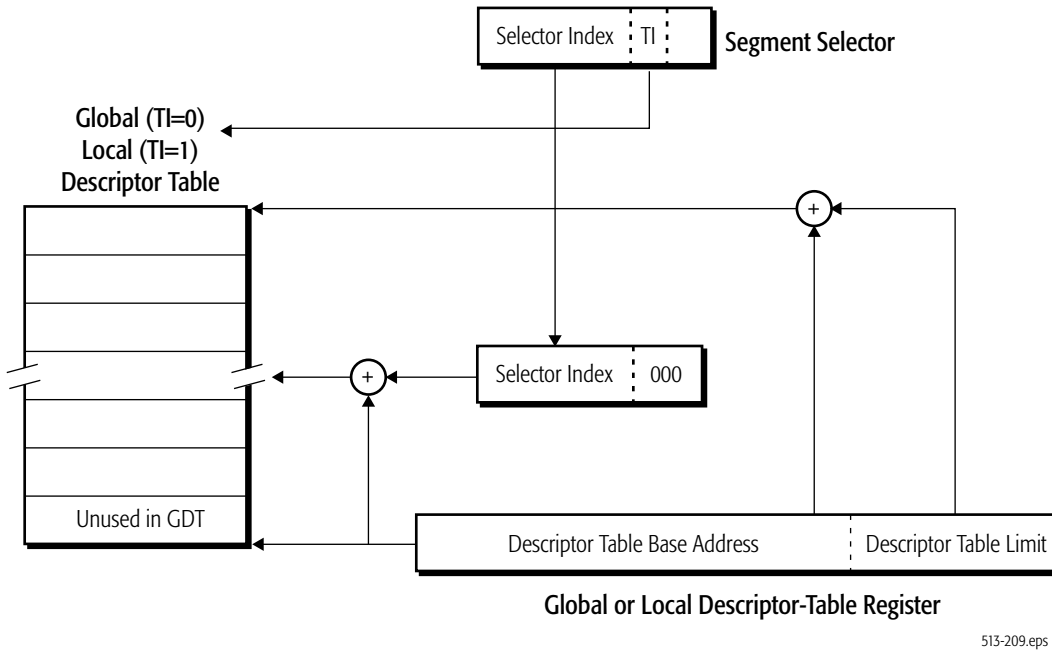

Figure 4-6. Global and Local Descriptor-Table Access

4.6.2 Global Descriptor-Table Register

The global descriptor-table register (GDTR) points to the location of the GDT in memory and defines its size. This register is loaded from memory using the LGDT instruction (see “LGDT and LIDT Instructions” on page 155). Figure 4-7 shows the format of the GDTR in legacy mode and compatibility mode.

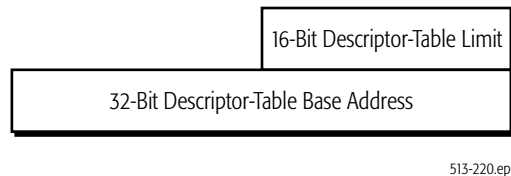

Figure 4-7. GDTR and IDTR Format—Legacy Modes

Figure 4-8 on page 73 shows the format of the GDTR in 64-bit mode.



513-266.eps

Figure 4-8. GDTR and IDTR Format—Long Mode

The GDTR contains two fields:

Limit. 2 bytes. These bits define the 16-bit limit, or size, of the GDT in bytes. The limit value is added to the base address to yield the ending byte address of the GDT. A general-protection exception (#GP) occurs if software attempts to access a descriptor beyond the GDT limit.

The offsets into the descriptor tables are not extended by the AMD64 architecture in support of long mode. Therefore, the GDTR and IDTR limit-field sizes are unchanged from the legacy sizes. The processor does check the limits in long mode during GDT and IDT accesses.

Base Address. 8 bytes. The base-address field holds the starting byte address of the GDT in virtual-memory space. The GDT can be located at any byte address in virtual memory, but system software should align the GDT on a doubleword boundary to avoid the potential performance penalties associated with accessing unaligned data.

The AMD64 architecture increases the base-address field of the GDTR to 64 bits so that system software running in long mode can locate the GDT anywhere in the 64-bit virtual-address space. The processor ignores the high-order 4 bytes of base address when running in legacy mode.

4.6.3 Local Descriptor Table

Protected-mode system software can optionally create a local descriptor table (LDT) to hold segment descriptors belonging to a single task or even multiple tasks. The LDT typically contains code-segment and data-segment descriptors as well as gate descriptors referenced by the specified task. Like the GDT, system software can store the LDT anywhere in memory and should protect the segment containing the LDT from non-privileged software.

Segment selectors point to the LDT when the table-index bit (TI) in the selector is set to 1. The selector index portion of the segment selector references a specific entry in the LDT (see Figure 4-6 on page 72). Unlike the GDT, however, a selector index of 0 references the first entry in the LDT (when TI=1, the selector is not a null selector).

LDTs are described by system-segment descriptor entries located in the GDT, and a GDT can contain multiple LDT descriptors. The LDT system-segment descriptor defines the location, size, and privilege rights for the LDT. Figure 4-9 on page 74 shows the relationship between the LDT and GDT data structures.

Loading a null selector into the LDTR is useful if software does not use an LDT. This causes a #GP if an erroneous reference is made to the LDT.

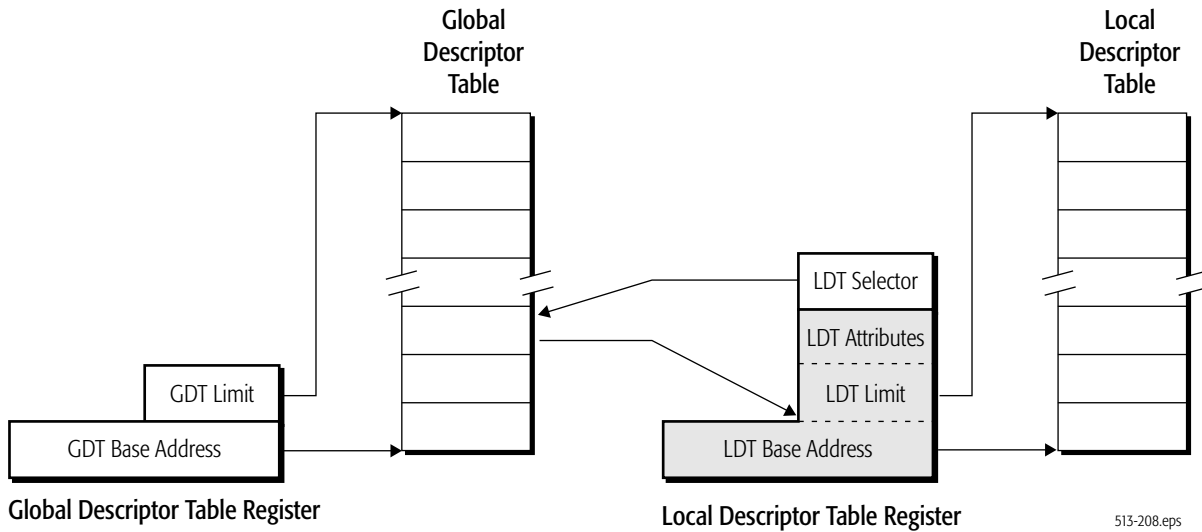

Figure 4-9. Relationship between the LDT and GDT

4.6.4 Local Descriptor-Table Register

The local descriptor-table register (LDTR) points to the location of the LDT in memory, defines its size, and specifies its attributes. The LDTR has two portions. A *visible* portion holds the LDT selector, and a *hidden* portion holds the LDT descriptor. When the LDT selector is loaded into the LDTR, the processor automatically loads the LDT descriptor from the GDT into the hidden portion of the LDTR. The LDTR is loaded in one of two ways:

- Using the LLDT instruction (see “LLDT and LTR Instructions” on page 155).
- Performing a task switch (see “Switching Tasks” on page 321).

Figure 4-10 on page 75 shows the format of the LDTR in legacy mode.

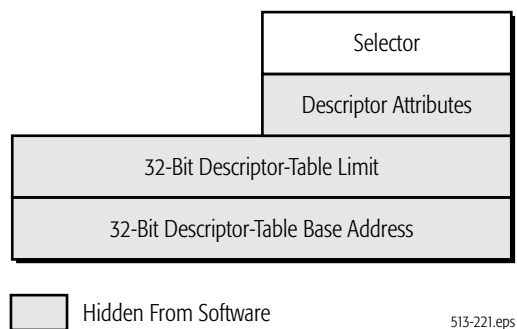

Figure 4-10. LDTR Format—Legacy Mode

Figure 4-11 shows the format of the LDTR in long mode (both compatibility mode and 64-bit mode).

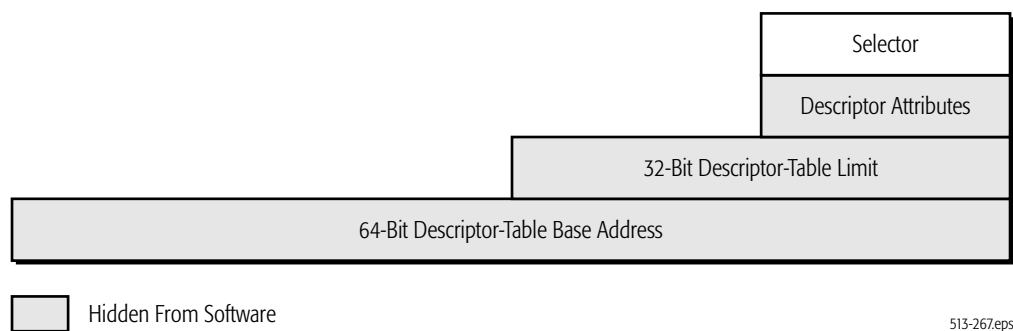

Figure 4-11. LDTR Format—Long Mode

The LDTR contains four fields:

LDT Selector. 2 bytes. These bits are loaded explicitly from the TSS during a task switch, or by using the LLDT instruction. The LDT selector must point to an LDT system-segment descriptor entry in the GDT. If it does not, a general-protection exception (#GP) occurs.

The following three fields are loaded automatically from the LDT descriptor in the GDT as a result of loading the LDT selector. The register fields are shown as shaded boxes in Figure 4-10 and Figure 4-11.

Base Address. The base-address field holds the starting byte address of the LDT in virtual-memory space. Like the GDT, the LDT can be located anywhere in system memory, but software should align the LDT on a doubleword boundary to avoid performance penalties associated with accessing unaligned data.

The AMD64 architecture expands the base-address field of the LDTR to 64 bits so that system software running in long mode can locate an LDT anywhere in the 64-bit virtual-address space. The processor ignores the high-order 32 base-address bits when running in legacy mode. Because the LDTR is loaded from the GDT, the system-segment descriptor format (LDTs are system segments) has been expanded by the AMD64 architecture in support of 64-bit mode. See “Long Mode Descriptor Summary” on page 92 for more information on this expanded format. The high-order base-address bits are only loaded from 64-bit mode using the LLDT instruction (see “LLDT and LTR Instructions” on page 155 for more information on this instruction).

Limit. This field defines the limit, or size, of the LDT in bytes. The LDT limit as stored in the LDTR is 32 bits. When the LDT limit is loaded from the GDT descriptor entry, the 20-bit limit field in the descriptor is expanded to 32 bits and scaled based on the value of the descriptor granularity (G) bit. For details on the limit biasing and granularity, see “Granularity (G) Bit” on page 79.

If an attempt is made to access a descriptor beyond the LDT limit, a general-protection exception (#GP) occurs.

The offsets into the descriptor tables are not extended by the AMD64 architecture in support of long mode. Therefore, the LDTR limit-field size is unchanged from the legacy size. The processor does check the LDT limit in long mode during LDT accesses.

Attributes. This field holds the descriptor attributes, such as privilege rights, segment presence and segment granularity.

4.6.5 Interrupt Descriptor Table

The final type of descriptor table is the interrupt descriptor table (IDT). Multiple IDTs can be maintained by system software. System software selects a specific IDT by loading the interrupt descriptor table register (IDTR) with a pointer to the IDT. As with the GDT and LDT, system software can store the IDT anywhere in memory and should protect the segment containing the IDT from non-privileged software.

The IDT can contain only the following types of gate descriptors:

- Interrupt gates
- Trap gates
- Task gates.

The use of gate descriptors by the interrupt mechanism is described in Chapter 8, “Exceptions and Interrupts.” A general-protection exception (#GP) occurs if the IDT descriptor referenced by an interrupt or exception is not one of the types listed above.

IDT entries are selected using the interrupt-vector number rather than a selector value. The interrupt-vector number is scaled by the interrupt-descriptor entry size to form an offset into the IDT. The interrupt-descriptor entry size depends on the processor operating mode as follows:

- In long mode, interrupt descriptor-table entries are 16 bytes.

- In legacy mode, interrupt descriptor-table entries are eight bytes.

Figure 4-12 shows how the interrupt-vector number indexes the IDT.

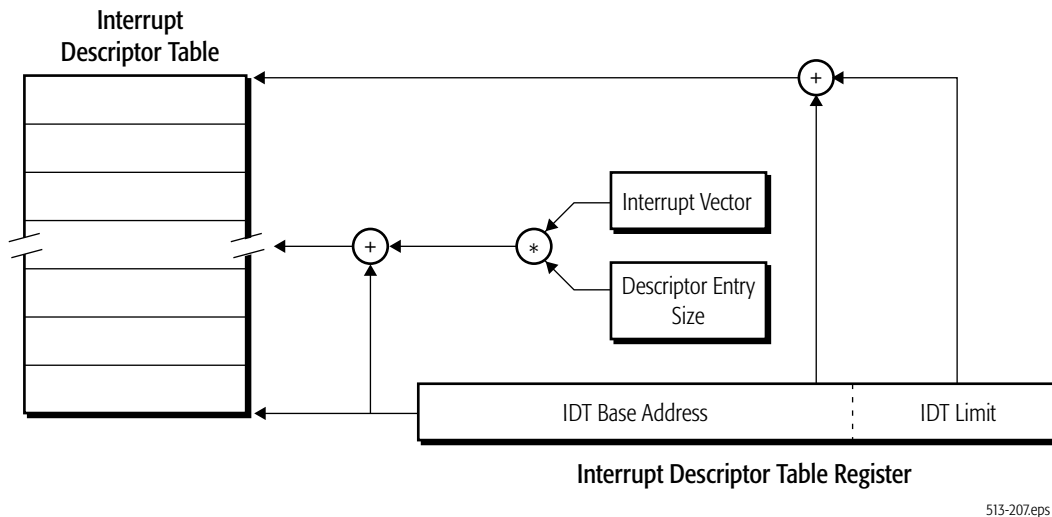

Figure 4-12. Indexing an IDT

4.6.6 Interrupt Descriptor-Table Register

The interrupt descriptor-table register (IDTR) points to the IDT in memory and defines its size. This register is loaded from memory using the LIDT instruction (see “LGDT and LIDT Instructions” on page 155). The format of the IDTR is identical to that of the GDTR in all modes. Figure 4-7 on page 72 shows the format of the IDTR in legacy mode. Figure 4-8 on page 73 shows the format of the IDTR in long mode.

The offsets into the descriptor tables are not extended by the AMD64 architecture in support of long mode. Therefore, the IDTR limit-field size is unchanged from the legacy size. The processor does check the IDT limit in long mode during IDT accesses.

4.7 Legacy Segment Descriptors

4.7.1 Descriptor Format

Segment descriptors define, protect, and isolate segments from each other. There are two basic types of descriptors, each of which are used to describe different segment (or gate) types:

- *User Segments*—These include code segments and data segments. Stack segments are a type of data segment.

- *System Segments*—System segments consist of LDT segments and task-state segments (TSS). Gate descriptors are another type of system-segment descriptor. Rather than describing segments, gate descriptors point to program entry points.

Figure 4-13 shows the generic format for user-segment and system-segment descriptors. User and system segments are differentiated using the S bit. S=1 indicates a user segment, and S=0 indicates a system segment. Gray shading indicates the field or bit is reserved. The format for a gate descriptor differs from the generic segment descriptor, and is described separately in “Gate Descriptors” on page 84.

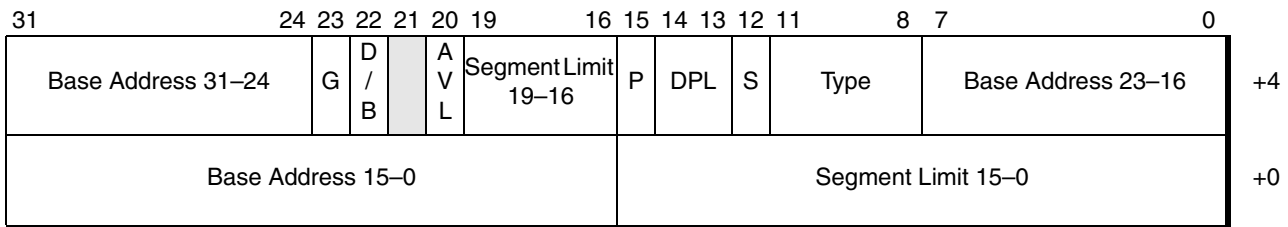

Figure 4-13. Generic Segment Descriptor—Legacy Mode

Figure 4-13 shows the fields in a generic, legacy-mode, 8-byte segment descriptor. In this figure, +0 indicates the address of the descriptor’s first byte, and +4 indicates the address of the descriptor’s fifth byte. The fields are defined as follows, from least-significant to most-significant bit positions:

Segment Limit. The 20-bit segment limit is formed by concatenating bits 19–16 of byte +4 with bits 15–0 of byte +0. The segment limit defines the segment size, in bytes. The granularity (G) bit controls how the segment-limit field is scaled (see “Granularity (G) Bit” on page 79). For data segments, the expand-down (E) bit determines whether the segment limit defines the lower or upper segment-boundary (see “Expand-Down (E) Bit” on page 82).

If software references a segment descriptor with an address beyond the segment limit, a general-protection exception (#GP) occurs. The #GP occurs if any part of the memory reference falls outside the segment limit. For example, a doubleword (4-byte) address reference causes a #GP if one or more bytes are located beyond the segment limit.

Base Address. The 32-bit base address is formed by concatenating bits 31–24 of byte +4 with bits 7–0 of byte +4, and with bits 15–0 of byte +0. The segment-base address field locates the start of a segment in virtual-address space.

S Bit and Type Field. Bit 12 of byte +4, and bits 11–8 of byte +4. The S and Type fields, together, specify the descriptor type and its access characteristics. Table 4-2 summarizes the descriptor types by S-field encoding and gives a cross reference to descriptions of the Type-field encodings.

Table 4-2. Descriptor Types

S Field	Descriptor Type	Type-Field Encoding
0 (System)	LDT	See Table 4-5 on page 83
	TSS	
	Gate	
1 (User)	Code	See Table 4-3 on page 81
	Data	See Table 4-4 on page 82

Descriptor Privilege-Level (DPL) Field. Bits 14–13 of byte +4. The DPL field indicates the descriptor-privilege level of the segment. DPL can be set to any value from 0 to 3, with 0 specifying the most privilege and 3 the least privilege. See “Data-Access Privilege Checks” on page 95 and “Control-Transfer Privilege Checks” on page 98 for more information on how the DPL is used during segment privilege-checks.

Present (P) Bit. Bit 15 of byte +4. The segment-present bit indicates that the segment referenced by the descriptor is loaded in memory. If a reference is made to a descriptor entry when P=0, a segment-not-present exception (#NP) occurs. This bit is set and cleared by system software and is never altered by the processor.

Available To Software (AVL) Bit. Bit 20 of byte +4. This field is available to software, which can write any value to it. The processor does not set or clear this field.

Default Operand Size (D/B) Bit. Bit 22 of byte +4. The default operand-size bit is found in code-segment and data-segment descriptors but not in system-segment descriptors. Setting this bit to 1 indicates a 32-bit default operand size, and clearing it to 0 indicates a 16-bit default size. The effect this bit has on a segment depends on the segment-descriptor type. See “Code-Segment Default-Operand Size (D) Bit” on page 81 for a description of the D bit in code-segment descriptors. “Data-Segment Default Operand Size (D/B) Bit” on page 83 describes the D bit in data-segment descriptors, including stack segments, where the bit is referred to as the “B” bit.

Granularity (G) Bit. Bit 23 of byte +4. The granularity bit specifies how the segment-limit field is scaled. Clearing the G bit to 0 indicates that the limit field is not scaled. In this case, the limit equals the number of bytes available in the segment. Setting the G bit to 1 indicates that the limit field is scaled by 4 Kbytes (4096 bytes). Here, the limit field equals the number of 4-Kbyte *blocks* available in the segment.

Setting a limit of 0 indicates a 1-byte segment limit when G = 0. Setting the same limit of 0 when G = 1 indicates a segment limit of 4095.

Reserved Bits. Generally, software should clear all reserved bits to 0, so they can be defined in future revisions to the AMD64 architecture.

4.7.2 Code-Segment Descriptors

Figure 4-14 shows the code-segment descriptor format (gray shading indicates the bit is reserved). All software tasks require that a segment selector, referencing a valid code-segment descriptor, is loaded into the CS register. Code segments establish the processor operating mode and execution privilege-level. The segments generally contain only instructions and are execute-only, or execute and read-only. Software cannot write into a segment whose selector references a code-segment descriptor.

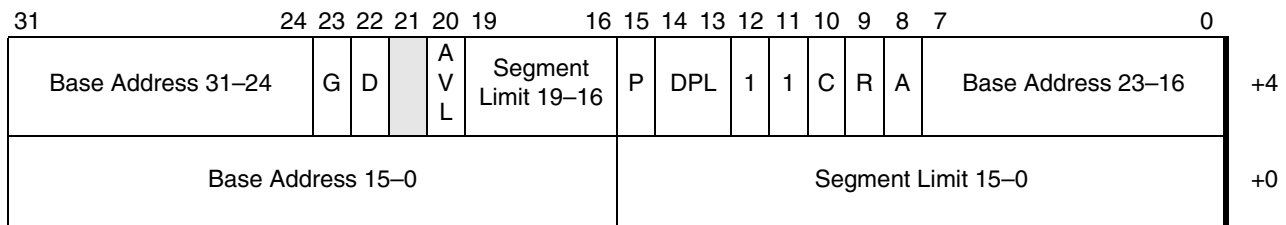

Figure 4-14. Code-Segment Descriptor—Legacy Mode

Code-segment descriptors have the S bit set to 1, identifying the segments as user segments. Type-field bit 11 differentiates code-segment descriptors (bit 11 set to 1) from data-segment descriptors (bit 11 cleared to 0). The remaining type-field bits (10–8) define the access characteristics for the code-segment, as follows:

Conforming (C) Bit. Bit 10 of byte +4. Setting this bit to 1 identifies the code segment as *conforming*. When control is transferred to a higher-privilege conforming code-segment (C=1) from a lower-privilege code segment, the processor CPL does not change. Transfers to non-conforming code-segments (C=0) with a higher privilege-level than the CPL can occur only through gate descriptors. See “Control-Transfer Privilege Checks” on page 98 for more information on conforming and non-conforming code-segments.

Readable (R) Bit. Bit 9 of byte +4. Setting this bit to 1 indicates the code segment is both executable and readable as data. When this bit is cleared to 0, the code segment is executable, but attempts to read data from the code segment cause a general-protection exception (#GP) to occur.

Accessed (A) Bit. Bit 8 of byte +4. The accessed bit is set to 1 by the processor when the descriptor is copied from the GDT or LDT into the CS register. This bit is only cleared by software.

Table 4-3 on page 81 summarizes the code-segment type-field encodings.

Table 4-3. Code-Segment Descriptor Types

Hex Value	Type Field				Description
	Bit 11 (Code/Data)	Bit 10	Bit 9	Bit 8	
		Conforming (C)	Readable (R)	Accessed (A)	
8	1	0	0	0	Execute-Only
9		0	0	1	Execute-Only — Accessed
A		0	1	0	Execute/Readable
B		0	1	1	Execute/Readable — Accessed
C		1	0	0	Conforming, Execute-Only
D		1	0	1	Conforming, Execute-Only — Accessed
E		1	1	0	Conforming, Execute/Readable
F		1	1	1	Conforming, Execute/Readable — Accessed

Code-Segment Default-Operand Size (D) Bit. Bit 22 of byte +4. In code-segment descriptors, the D bit selects the default operand size and address sizes. In legacy mode, when D=0 the default operand size and address size is 16 bits and when D=1 the default operand size and address size is 32 bits. Instruction prefixes can be used to override the operand size or address size, or both.

4.7.3 Data-Segment Descriptors

Figure 4-15 shows the data-segment descriptor format. Data segments contain non-executable information and can be accessed as read-only or read/write. They are referenced using the DS, ES, FS, GS, or SS data-segment registers. The DS data-segment register holds the segment selector for the default data segment. The ES, FS and GS data-segment registers hold segment selectors for additional data segments usable by the current software task.

The stack segment is a special form of data-segment register. It is referenced using the SS segment register and must be read/write. When loading the SS register, the processor requires that the selector reference a valid, writable data-segment descriptor.

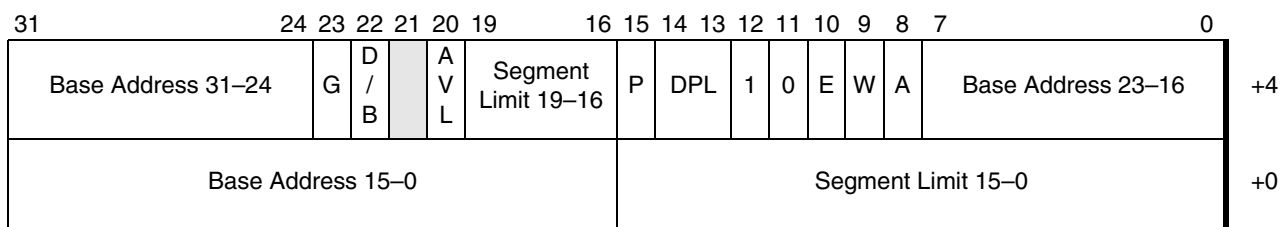

Figure 4-15. Data-Segment Descriptor—Legacy Mode

Data-segment descriptors have the S bit set to 1, identifying them as user segments. Type-field bit 11 differentiates data-segment descriptors (bit 11 cleared to 0) from code-segment descriptors (bit 11 set to 1). The remaining type-field bits (10–8) define the data-segment access characteristics, as follows:

Expand-Down (E) Bit. Bit 10 of byte +4. Setting this bit to 1 identifies the data segment as *expand-down*. In expand-down segments, the segment limit defines the *lower* segment boundary while the base is the upper boundary. Valid segment offsets in expand-down segments lie in the byte range limit+1 to FFFFh or FFFF_FFFFh, depending on the value of the data segment default operand size (D/B) bit.

Expand-down segments are useful for stacks, which grow in the downward direction as elements are pushed onto the stack. The stack pointer, ESP, is *decremented* by an amount equal to the operand size as a result of executing a PUSH instruction.

Clearing the E bit to 0 identifies the data segment as expand-up. Valid segment offsets in expand-up segments lie in the byte range 0 to segment limit.

Writable (W) Bit. Bit 9 of byte +4. Setting this bit to 1 identifies the data segment as read/write. When this bit is cleared to 0, the segment is read-only. A general-protection exception (#GP) occurs if software attempts to write into a data segment when W=0.

Accessed (A) Bit. Bit 8 of byte +4. The accessed bit is set to 1 by the processor when the descriptor is copied from the GDT or LDT into one of the data-segment registers or the stack-segment register. This bit is only cleared by software.

Table 4-4 summarizes the data-segment type-field encodings.

Table 4-4. Data-Segment Descriptor Types

Hex Value	Type Field			Description	
	Bit 11 (Code/Data)	Bit 10 Expand-Down (E)	Bit 9 Writable (W)		Bit 8 Accessed (A)
0	0	0	0	0	Read-Only
1		0	0	1	Read-Only — Accessed
2		0	1	0	Read/Write
3		0	1	1	Read/Write — Accessed
4		1	0	0	Expand-down, Read-Only
5		1	0	1	Expand-down, Read-Only — Accessed
6		1	1	0	Expand-down, Read/Write
7		1	1	1	Expand-down, Read/Write — Accessed

Data-Segment Default Operand Size (D/B) Bit. Bit 22 of byte +4. For expand-down data segments (E=1), setting D=1 sets the upper bound of the segment at 0_FFFF_FFFFh. Clearing D=0 sets the upper bound of the segment at 0_FFFFh.

In the case where a data segment is referenced by the stack selector (SS), the D bit is referred to as the B bit. For stack segments, the B bit sets the default stack size. Setting B=1 establishes a 32-bit stack referenced by the 32-bit ESP register. Clearing B=0 establishes a 16-bit stack referenced by the 16-bit SP register.

4.7.4 System Descriptors

There are two general types of system descriptors: system-segment descriptors and gate descriptors. System-segment descriptors are used to describe the LDT and TSS segments. Gate descriptors do not describe segments, but instead hold pointers to code-segment descriptors. Gate descriptors are used for protected-mode control transfers between less-privileged and more-privileged software.

System-segment descriptors have the S bit cleared to 0. The type field is used to differentiate the various LDT, TSS, and gate descriptors from one another. Table 4-5 summarizes the system-segment type-field encodings.

Table 4-5. System-Segment Descriptor Types (S=0)—Legacy Mode

Hex Value	Type Field (Bits 11–8)	Description
0	0000	Reserved (Illegal)
1	0001	Available 16-bit TSS
2	0010	LDT
3	0011	Busy 16-bit TSS
4	0100	16-bit Call Gate
5	0101	Task Gate
6	0110	16-bit Interrupt Gate
7	0111	16-bit Trap Gate
8	1000	Reserved (Illegal)
9	1001	Available 32-bit TSS
A	1010	Reserved (Illegal)
B	1011	Busy 32-bit TSS
C	1100	32-bit Call Gate
D	1101	Reserved (Illegal)
E	1110	32-bit Interrupt Gate
F	1111	32-bit Trap Gate

Figure 4-16 shows the legacy-mode system-segment descriptor format used for referencing LDT and TSS segments (gray shading indicates the bit is reserved). This format is also used in compatibility mode. The system-segments are used as follows:

- The LDT typically holds segment descriptors belonging to a single task (see “Local Descriptor Table” on page 73).
- The TSS is a data structure for holding processor-state information. Processor state is saved in a TSS when a task is suspended, and state is restored from the TSS when a task is restarted. System software must create at least one TSS referenced by the task register, TR. See “Legacy Task-State Segment” on page 313 for more information on the TSS.

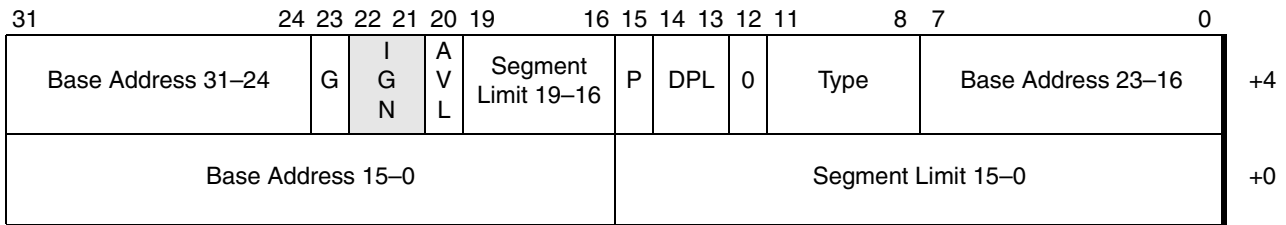

Figure 4-16. LDT and TSS Descriptor—Legacy/Compatibility Modes

4.7.5 Gate Descriptors

Gate descriptors hold pointers to code segments and are used to control access between code segments with different privilege levels. There are four types of gate descriptors:

- *Call Gates*—These gates (Figure 4-17 on page 85) are located in the GDT or LDT and are used to control access between code segments in the same task or in different tasks. See “Control Transfers Through Call Gates” on page 102 for information on how call gates are used to control access between code segments operating in the same task. The format of a call-gate descriptor is shown in Figure 4-17 on page 85.
- *Interrupt Gates* and *Trap Gates*—These gates (Figure 4-18 on page 85) are located in the IDT and are used to control access to interrupt-service routines. “Legacy Protected-Mode Interrupt Control Transfers” on page 231 contains information on using these gates for interrupt-control transfers. The format of interrupt-gate and trap-gate descriptors is shown in Figure 4-17 on page 85.
- *Task Gates*—These gates (Figure 4-19 on page 85) are used to control access between different tasks. They are also used to transfer control to interrupt-service routines if those routines are themselves a separate task. See “Task-Management Resources” on page 308 for more information on task gates and their use.

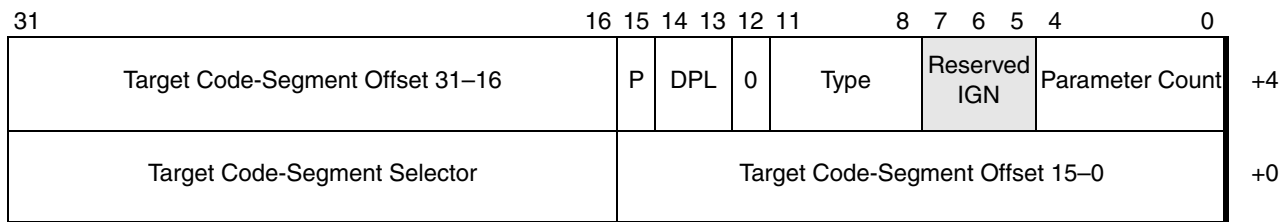

Figure 4-17. Call-Gate Descriptor—Legacy Mode

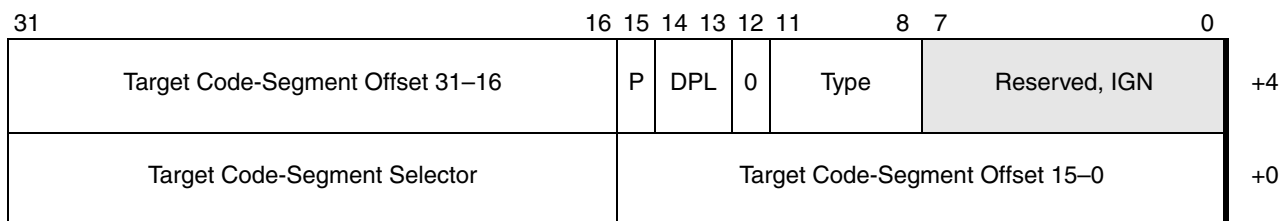

Figure 4-18. Interrupt-Gate and Trap-Gate Descriptors—Legacy Mode

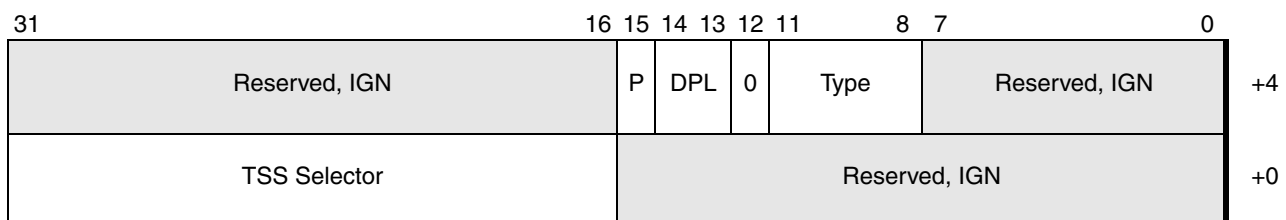

Figure 4-19. Task-Gate Descriptor—Legacy Mode

There are several differences between the gate-descriptor format and the system-segment descriptor format. These differences are described as follows, from least-significant to most-significant bit positions:

Target Code-Segment Offset. The 32-bit segment offset is formed by concatenating bits 31–16 of byte +4 with bits 15–0 of byte +0. The segment-offset field specifies the target-procedure entry point (offset) into the segment. This field is loaded into the EIP register as a result of a control transfer using the gate descriptor.

Target Code-Segment Selector. Bits 31–16 of byte +0. The segment-selector field identifies the target-procedure segment descriptor, located in either the GDT or LDT. The segment selector is loaded into the CS segment register as a result of a control transfer using the gate descriptor.

TSS Selector. Bits 31–16 of byte +0 (task gates only). This field identifies the target-task TSS descriptor, located in any of the three descriptor tables (GDT, LDT, and IDT).

Parameter Count (Call Gates Only). Bits 4–0 of byte +4. Legacy-mode call-gate descriptors contain a 5-bit *parameter-count* field. This field specifies the number of parameters to be copied from the currently-executing program stack to the target program stack during an automatic stack switch. Automatic stack switches are performed by the processor during a control transfer through a call gate to a greater privilege-level. The parameter size depends on the call-gate size as specified in the type field. 32-bit call gates copy 4-byte parameters, and 16-bit call gates copy 2-byte parameters. See “Stack Switching” on page 106 for more information on call-gate parameter copying.

4.8 Long-Mode Segment Descriptors

The interpretation of descriptor fields is changed in long mode, and in some cases the format is expanded. The changes depend on the operating mode (compatibility mode or 64-bit mode) and on the descriptor type. The following sections describe the changes.

4.8.1 Code-Segment Descriptors

Code segments continue to exist in long mode. Code segments and their associated descriptors and selectors are needed to establish the processor operating mode as well as execution privilege-level. The new L attribute specifies whether the processor is running in compatibility mode or 64-bit mode (see “Long (L) Attribute Bit” on page 87). Figure 4-20 shows the long-mode code-segment descriptor format. In compatibility mode, the code-segment descriptor is interpreted and behaves just as it does in legacy mode as described in “Code-Segment Descriptors” on page 80.

In Figure 4-20, gray shading indicates the code-segment descriptor fields that are *ignored in 64-bit mode* when the descriptor is used during a memory reference. However, the fields are loaded whenever the segment register is loaded in 64-bit mode.

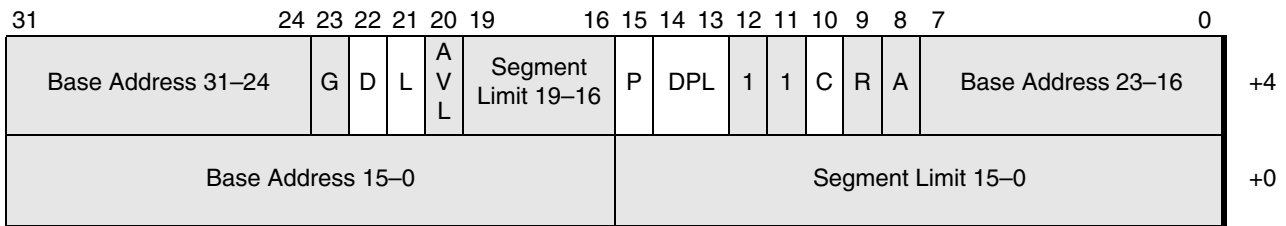

Figure 4-20. Code-Segment Descriptor—Long Mode

Fields Ignored in 64-Bit Mode. Segmentation is disabled in 64-bit mode, and code segments span all of virtual memory. In this mode, code-segment base addresses are ignored. For the purpose of virtual-address calculations, the base address is treated as if it has a value of zero.

Segment-limit checking is not performed, and both the segment-limit field and granularity (G) bit are ignored. Instead, the virtual address is checked to see if it is in canonical-address form.

The readable (R) and accessed (A) attributes in the type field are also ignored.

Long (L) Attribute Bit. Bit 21 of byte +4. Long mode introduces a new attribute, the *long* (L) bit, in code-segment descriptors. This bit specifies that the processor is running in 64-bit mode (L=1) or compatibility mode (L=0). When the processor is running in legacy mode, this bit is reserved.

Compatibility mode, maintains binary compatibility with legacy 16-bit and 32-bit applications. Compatibility mode is selected on a code-segment basis, and it allows legacy applications to coexist under the same 64-bit system software along with 64-bit applications running in 64-bit mode. System software running in long mode can execute existing 16-bit and 32-bit applications by clearing the L bit of the code-segment descriptor to 0.

When L=0, the legacy meaning of the code-segment D bit (see “Code-Segment Default-Operand Size (D) Bit” on page 81)—and the address-size and operand-size prefixes—are observed. Segmentation is enabled when L=0. From an application viewpoint, the processor is in a legacy 16-bit or 32-bit operating environment (depending on the D bit), even though long mode is activated.

If the processor is running in 64-bit mode (L=1), the only valid setting of the D bit is 0. This setting produces a default operand size of 32 bits and a default address size of 64 bits. The combination L=1 and D=1 is reserved for future use.

“Instruction Prefixes” in Volume 3 describes the effect of the code-segment L and D bits on default operand and address sizes when long mode is activated. These default sizes can be overridden with operand size, address size, and REX prefixes.

4.8.2 Data-Segment Descriptors

Data segments continue to exist in long mode. Figure 4-21 shows the long-mode data-segment descriptor format. In compatibility mode, data-segment descriptors are interpreted and behave just as they do in legacy mode.

In Figure 4-21, gray shading indicates the fields that are *ignored in 64-bit mode* when the descriptor is used during a memory reference. However, the fields are loaded whenever the segment register is loaded in 64-bit mode.

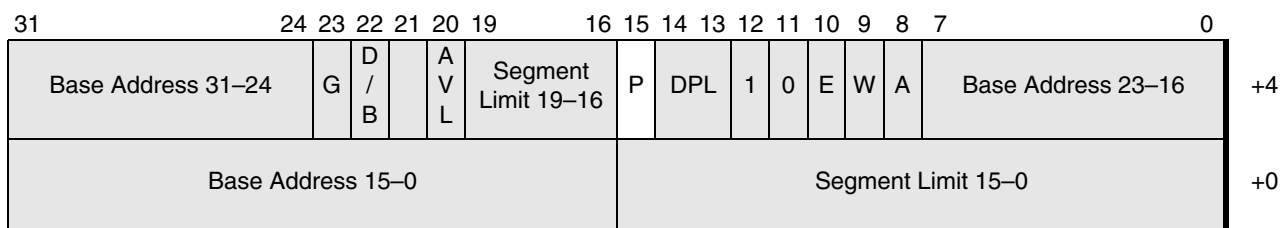

Figure 4-21. Data-Segment Descriptor—Long Mode

Fields Ignored in 64-Bit Mode. Segmentation is disabled in 64-bit mode. The interpretation of the segment-base address depends on the segment register used:

- In data-segment descriptors referenced by the DS, ES and SS segment registers, the base-address field is ignored. For the purpose of virtual-address calculations, the base address is treated as if it has a value of zero.
- Data segments referenced by the FS and GS segment registers receive special treatment in 64-bit mode. For these segments, the base address field is not ignored, and a non-zero value can be used in virtual-address calculations. A 64-bit segment-base address can be specified using model-specific registers. See “FS and GS Registers in 64-Bit Mode” on page 70 for more information.

Segment-limit checking is not performed on any data segments in 64-bit mode, and both the segment-limit field and granularity (G) bit are ignored. The D/B bit is unused in 64-bit mode.

The expand-down (E), writable (W), and accessed (A) type-field attributes are ignored.

A data-segment-descriptor DPL field is ignored in 64-bit mode, and segment-privilege checks are not performed on data segments. System software can use the page-protection mechanisms to isolate and protect data from unauthorized access.

4.8.3 System Descriptors

In long mode, the allowable system-descriptor types encoded by the type field are changed. Some descriptor types are modified, and others are illegal. The changes are summarized in Table 4-6. An attempt to use an illegal descriptor type causes a general-protection exception (#GP).

Table 4-6. System-Segment Descriptor Types—Long Mode

Hex Value	Type Field				Description
	Bit 11	Bit 10	Bit 9	Bit 8	
0	0	0	0	0	Reserved (Illegal)
1	0	0	0	1	
2	0	0	1	0	64-bit LDT ¹
3	0	0	1	1	Reserved (Illegal)
4	0	1	0	0	
5	0	1	0	1	
6	0	1	1	0	
7	0	1	1	1	
8	1	0	0	0	Available 64-bit TSS
9	1	0	0	1	
A	1	0	1	0	Reserved (Illegal)
B	1	0	1	1	Busy 64-bit TSS
C	1	1	0	0	64-bit Call Gate

Note:
1. In 64-bit mode only. In compatibility mode, the type specifies a 32-bit LDT.

Table 4-6. System-Segment Descriptor Types—Long Mode (continued)

Hex Value	Type Field				Description
	Bit 11	Bit 10	Bit 9	Bit 8	
D	1	1	0	1	Reserved (Illegal)
E	1	1	1	0	64-bit Interrupt Gate
F	1	1	1	1	64-bit Trap Gate

Note:
1. In 64-bit mode only. In compatibility mode, the type specifies a 32-bit LDT.

In long mode, the modified system-segment descriptor types are:

- The 32-bit LDT (02h), which is redefined as the 64-bit LDT.
- The available 32-bit TSS (09h), which is redefined as the available 64-bit TSS.
- The busy 32-bit TSS (0Bh), which is redefined as the busy 64-bit TSS.

In 64-bit mode, the LDT and TSS system-segment descriptors are expanded by 64 bits, as shown in Figure 4-22. In this figure, gray shading indicates the fields that are *ignored in 64-bit mode*. Expanding the descriptors allows them to hold 64-bit base addresses, so their segments can be located anywhere in the virtual-address space. The expanded descriptor can be loaded into the corresponding descriptor-table register (LDTR or TR) only from 64-bit mode. In compatibility mode, the legacy system-segment descriptor format, shown in Figure 4-16 on page 84, is used. See “LLDT and LTR Instructions” on page 155 for more information.

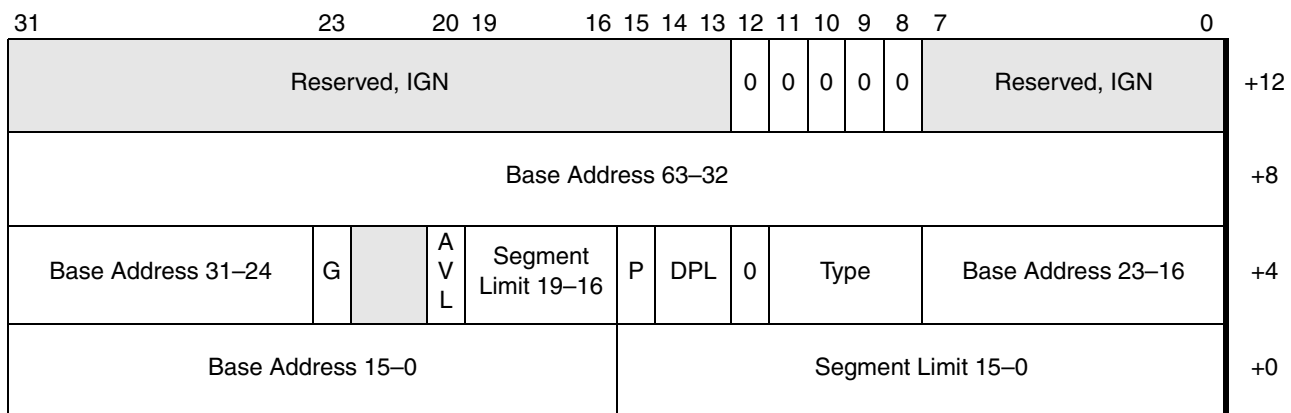
**Figure 4-22. System-Segment Descriptor—64-Bit Mode**

The 64-bit system-segment base address must be in canonical form. Otherwise, a general-protection exception occurs with a selector error-code, #GP(selector), when the system segment is loaded. System-segment limit values are checked by the processor in both 64-bit and compatibility modes, under the control of the granularity (G) bit.

Figure 4-22 shows that bits 12–8 of dword +12 must be cleared to 0. These bits correspond to the S and Type fields in a legacy descriptor. Clearing these bits to 0 corresponds to an illegal type in legacy mode

and causes a #GP if an attempt is made to access the upper half of a 64-bit mode system-segment descriptor as a legacy descriptor or as the lower half of a 64-bit mode system-segment descriptor.

4.8.4 Gate Descriptors

As shown in Table 4-6 on page 88, the allowable gate-descriptor types are changed in long mode. Some gate-descriptor types are modified and others are illegal. The modified gate-descriptor types in long mode are:

- The 32-bit call gate (0Ch), which is redefined as the 64-bit call gate.
- The 32-bit interrupt gate (0Eh), which is redefined as the 64-bit interrupt gate.
- The 32-bit trap gate (0Fh), which is redefined as the 64-bit trap gate.

In long mode, several gate-descriptor types are illegal. An attempt to use these gates causes a general-protection exception (#GP) to occur. The illegal gate types are:

- The 16-bit call gate (04h).
- The task gate (05h).
- The 16-bit interrupt gate (06h).
- The 16-bit trap gate (07h).

In long mode, gate descriptors are expanded by 64 bits, allowing them to hold 64-bit offsets. The 64-bit call-gate descriptor is shown in Figure 4-23 and the 64-bit interrupt gate and trap gate are shown in Figure 4-24 on page 91. In these figures, gray shading indicates the fields that are *ignored in long mode*. The interrupt and trap gates contain an additional field, the IST, that is not present in the call gate—see “IST Field (Interrupt and Trap Gates)” on page 91.

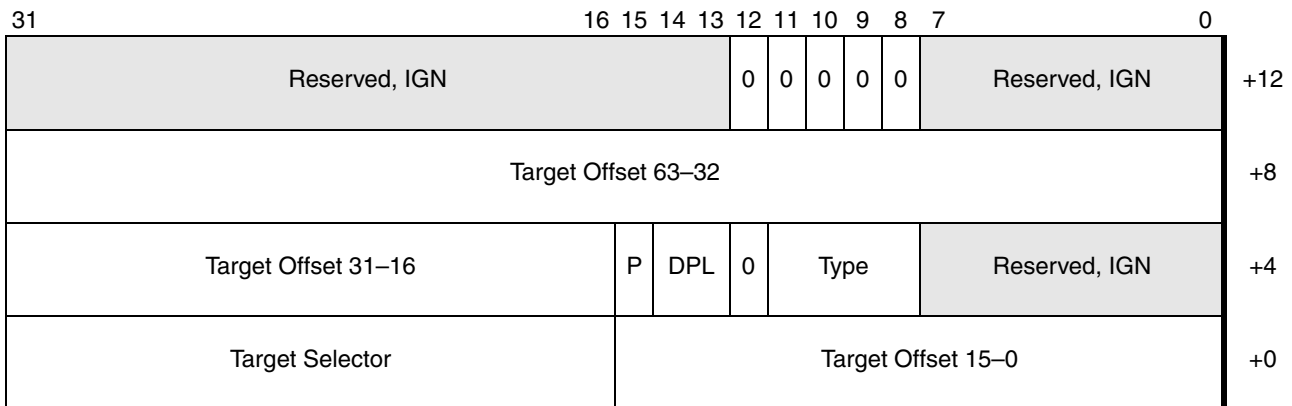

Figure 4-23. Call-Gate Descriptor—Long Mode

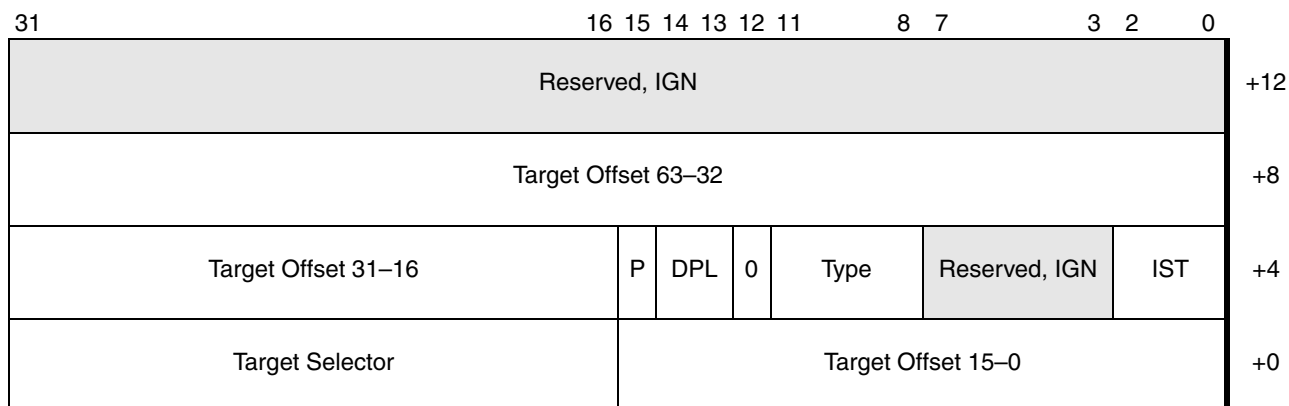

Figure 4-24. Interrupt-Gate and Trap-Gate Descriptors—Long Mode

The target code segment referenced by a long-mode gate descriptor must be a 64-bit code segment (CS.L=1, CS.D=0). If the target is not a 64-bit code segment, a general-protection exception, #GP(error), occurs. The error code reported depends on the gate type:

- Call gates report the target code-segment selector as the error code.
- Interrupt and trap gates report the interrupt-vector number as the error code.

A general-protection exception, #GP(0), occurs if software attempts to reference a long-mode gate descriptor with a target-segment offset that is not in canonical form.

It is possible for software to store legacy and long mode gate descriptors in the same descriptor table. Figure 4-23 on page 90 shows that bits 12–8 of byte +12 in a long-mode call gate must be cleared to 0. These bits correspond to the S and Type fields in a legacy call gate. Clearing these bits to 0 corresponds to an illegal type in legacy mode and causes a #GP if an attempt is made to access the upper half of a 64-bit mode call-gate descriptor as a legacy call-gate descriptor.

It is not necessary to clear these same bits in a long-mode interrupt gate or trap gate. In long mode, the interrupt-descriptor table (IDT) must contain 64-bit interrupt gates or trap gates. The processor automatically indexes the IDT by scaling the interrupt vector by 16. This makes it impossible to access the upper half of a long-mode interrupt gate, or trap gate, as a legacy gate when the processor is running in long mode.

IST Field (Interrupt and Trap Gates). Bits 2–0 of byte +4. Long-mode interrupt gate and trap gate descriptors contain a new, 3-bit interrupt-stack-table (IST) field not present in legacy gate descriptors. The IST field is used as an index into the IST portion of a long-mode TSS. If the IST field is not 0, the index references an IST pointer in the TSS, which the processor loads into the RSP register when an interrupt occurs. If the IST index is 0, the processor uses the legacy stack-switching mechanism (with some modifications) when an interrupt occurs. See “Interrupt-Stack Table” on page 245 for more information.

Count Field (Call Gates). The count field found in legacy call-gate descriptors is not supported in long-mode call gates. In long mode, the field is reserved and should be cleared to zero.

4.8.5 Long Mode Descriptor Summary

System descriptors and gate descriptors are expanded by 64 bits to handle 64-bit base addresses in long mode or 64-bit mode. The mode in which the expansion occurs depends on the purpose served by the descriptor, as follows:

- *Expansion Only In 64-Bit Mode*—The system descriptors and pseudo-descriptors that are loaded into the GDTR, IDTR, LDTR, and TR registers are expanded only in 64-bit mode. They are not expanded in compatibility mode.
- *Expansion In Long Mode*—Gate descriptors (call gates, interrupt gates, and trap gates) are expanded in long mode (both 64-bit mode and compatibility mode). Task gates and 16-bit gate descriptors are illegal in long mode.

The AMD64 architecture redefines several of the descriptor-entry fields in support of long mode. The specific change depends on whether the processor is in 64-bit mode or compatibility mode. Table 4-7 summarizes the changes in the descriptor entry field when the descriptor entry is loaded into a segment register (as opposed to when the segment register is subsequently used to access memory).

Table 4-7. Descriptor-Entry Field Changes in Long Mode

Descriptor Field	Descriptor Type	Long Mode	
		Compatibility Mode	64-Bit Mode
Limit	Code	Same as legacy x86	Same as legacy x86
	Data		
	System		
Offset	Gate	Expanded to 64 bits	Expanded to 64 bits
Base	Code	Same as legacy x86	Same as legacy x86
	Data		
	System		
Selector	Gate	Same as legacy x86	
IST ¹	Gate	Interrupt and trap gates only. (New for long mode.)	
S and Type	Code	Same as legacy x86	Same as legacy x86
	Data		
	System	Types 02h, 09h, and 0Bh redefined Types 01h and 03h are illegal	
	Gate	Types 0Ch, 0Eh, and 0Fh redefined Types 04h–07h are illegal	
Note:			
1. Not available (reserved) in legacy mode.			

Table 4-7. Descriptor-Entry Field Changes in Long Mode (continued)

Descriptor Field	Descriptor Type	Long Mode	
		Compatibility Mode	64-Bit Mode
DPL	Code	Same as legacy x86	Same as legacy x86
	Data		
	System		
	Gate		
Present	Code	Same as legacy x86	Same as legacy x86
	Data		
	System		
	Gate		
Default Size	Code	Same as legacy x86	D=0 Indicates 64-bit address, 32-bit data D=1 Reserved
	Data		Same as legacy x86
Long ¹	Code	Specifies compatibility mode	Specifies 64-bit mode
Granularity	Code	Same as legacy x86	Same as legacy x86
	Data		
	System		
Available	Code	Same as legacy x86	Same as legacy x86
	Data		
	System		
Note:			
1. Not available (reserved) in legacy mode.			

4.9 Segment-Protection Overview

The AMD64 architecture is designed to fully support the legacy segment-protection mechanism. The segment-protection mechanism provides system software with the ability to restrict program access into other software routines and data.

Segment-level protection remains enabled in compatibility mode. 64-bit mode eliminates most type checking, and limit checking is not performed, except on accesses to system-descriptor tables.

The preferred method of implementing memory protection in a long-mode operating system is to rely on the page-protection mechanism as described in “Page-Protection Checks” on page 142. System software still needs to create basic segment-protection data structures for 64-bit mode. These structures are simplified, however, by the use of the flat-memory model in 64-bit mode, and the limited segmentation checks performed when executing in 64-bit mode.

4.9.1 Privilege-Level Concept

Segment protection is used to isolate and protect programs and data from each other. The segment-protection mechanism supports four privilege levels in protected mode. The privilege levels are designated with a numerical value from 0 to 3, with 0 being the most privileged and 3 being the least privileged. System software typically assigns the privilege levels in the following manner:

- *Privilege-level 0 (most privilege)*—This level is used by critical system-software components that require direct access to, and control over, all processor and system resources. This can include BIOS, memory-management functions, and interrupt handlers.
- *Privilege-levels 1 and 2 (moderate privilege)*—These levels are used by less-critical system-software services that can access and control a limited scope of processor and system resources. Software running at these privilege levels might include some device drivers and library routines. These software routines can call more-privileged system-software services to perform functions such as memory garbage-collection and file allocation.
- *Privilege-level 3 (least privilege)*—This level is used by application software. Software running at privilege-level 3 is normally prevented from directly accessing most processor and system resources. Instead, applications request access to the protected processor and system resources by calling more-privileged service routines to perform the accesses.

Figure 4-25 shows the relationship of the four privilege levels to each other.

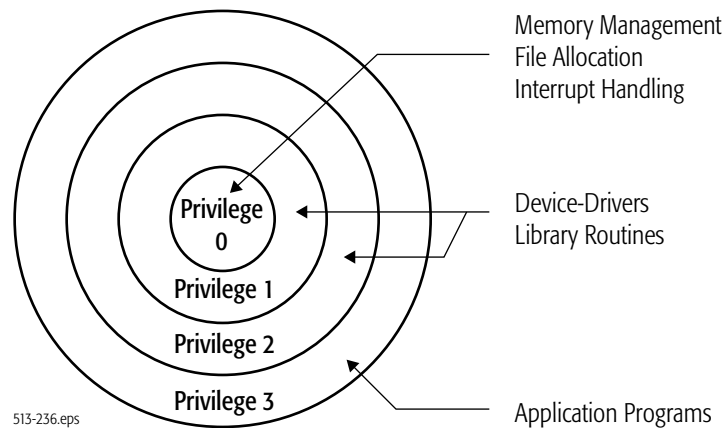

Figure 4-25. Privilege-Level Relationships

4.9.2 Privilege-Level Types

There are three types of privilege levels the processor uses to control access to segments. These are CPL, DPL, and RPL.

Current Privilege-Level. The current privilege-level (CPL) is the privilege level at which the processor is currently executing. The CPL is stored in an internal processor register that is invisible to

software. Software changes the CPL by performing a control transfer to a different code segment with a new privilege level.

Descriptor Privilege-Level. The descriptor privilege-level (DPL) is the privilege level that system software assigns to individual segments. The DPL is used in privilege checks to determine whether software can access the segment referenced by the descriptor. In the case of gate descriptors, the DPL determines whether software can access the descriptor reference by the gate. The DPL is stored in the segment (or gate) descriptor.

Requestor Privilege-Level. The requestor privilege-level (RPL) reflects the privilege level of the program that created the selector. The RPL can be used to let a called program know the privilege level of the program that initiated the call. The RPL is stored in the selector used to reference the segment (or gate) descriptor.

The following sections describe how the CPL, DPL, and RPL are used by the processor in performing privilege checks on data accesses and control transfers. Failure to pass a protection check generally causes an exception to occur.

4.10 Data-Access Privilege Checks

4.10.1 Accessing Data Segments

Before loading a data-segment register (DS, ES, FS, or GS) with a segment selector, the processor checks the privilege levels as follows to see if access is allowed:

1. The processor compares the CPL with the RPL in the data-segment selector and determines the effective privilege level for the data access. The processor sets the effective privilege level to the lowest privilege (numerically-higher value) indicated by the comparison.
2. The processor compares the effective privilege level with the DPL in the descriptor-table entry referenced by the segment selector. If the effective privilege level is greater than or equal to (numerically lower-than or equal-to) the DPL, then the processor loads the segment register with the data-segment selector. The processor automatically loads the corresponding descriptor-table entry into the hidden portion of the segment register.

If the effective privilege level is lower than (numerically greater-than) the DPL, a general-protection exception (#GP) occurs and the segment register is not loaded.

Figure 4-26 on page 96 shows two examples of data-access privilege checks.

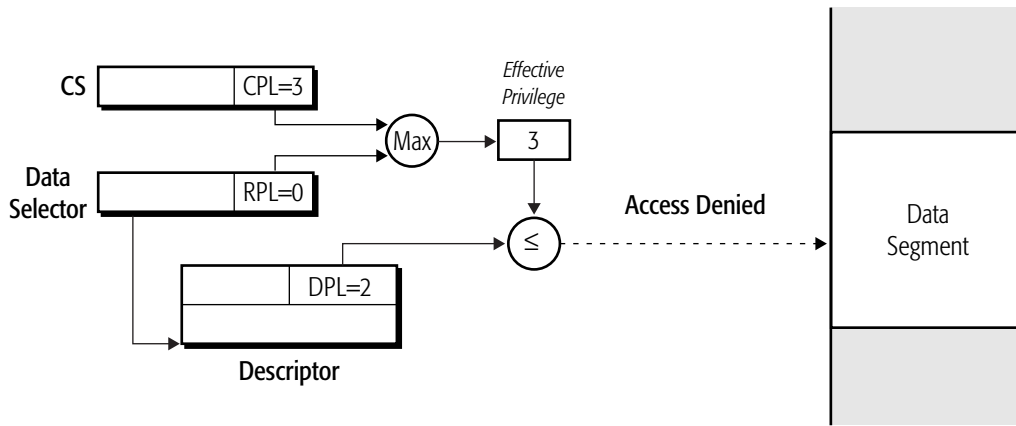

Example 1: Privilege Check Fails

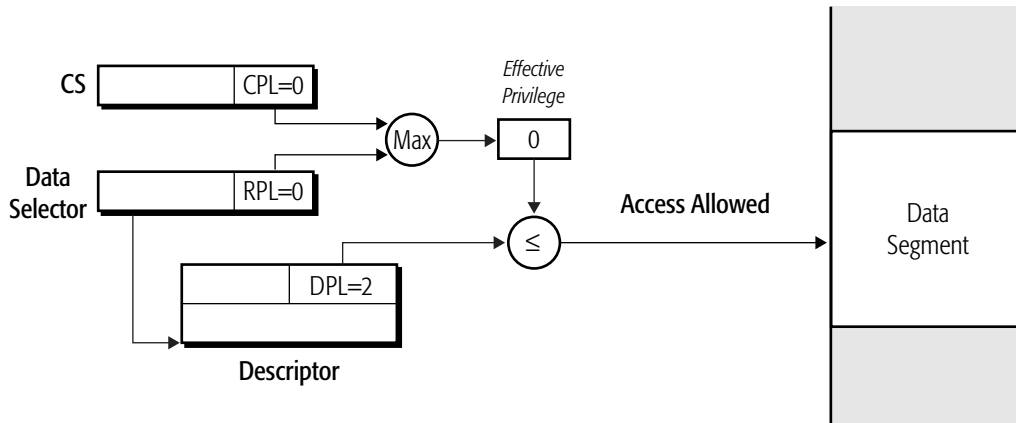

Example 2: Privilege Check Passes

513-229.eps

Figure 4-26. Data-Access Privilege-Check Examples

Example 1 in Figure 4-26 shows a failing data-access privilege check. The effective privilege level is 3 because $CPL=3$. This value is greater than the descriptor DPL , so access to the data segment is denied.

Example 2 in Figure 4-26 shows a passing data-access privilege check. Here, the effective privilege level is 0 because both the CPL and RPL have values of 0. This value is less than the descriptor DPL , so access to the data segment is allowed, and the data-segment register is successfully loaded.

4.10.2 Accessing Stack Segments

Before loading the stack segment register (SS) with a segment selector, the processor checks the privilege levels as follows to see if access is allowed:

1. The processor checks that the CPL and the stack-selector RPL are *equal*. If they are not equal, a general-protection exception (#GP) occurs and the SS register is not loaded.
2. The processor compares the CPL with the DPL in the descriptor-table entry referenced by the segment selector. The two values *must be equal*. If they are not equal, a #GP occurs and the SS register is not loaded.

Figure 4-27 shows two examples of stack-access privilege checks. In Example 1 the CPL, stack-selector RPL, and stack segment-descriptor DPL are all equal, so access to the stack segment using the SS register is allowed. In Example 2, the stack-selector RPL and stack segment-descriptor DPL are both equal. However, the CPL is not equal to the stack segment-descriptor DPL, and access to the stack segment through the SS register is denied.

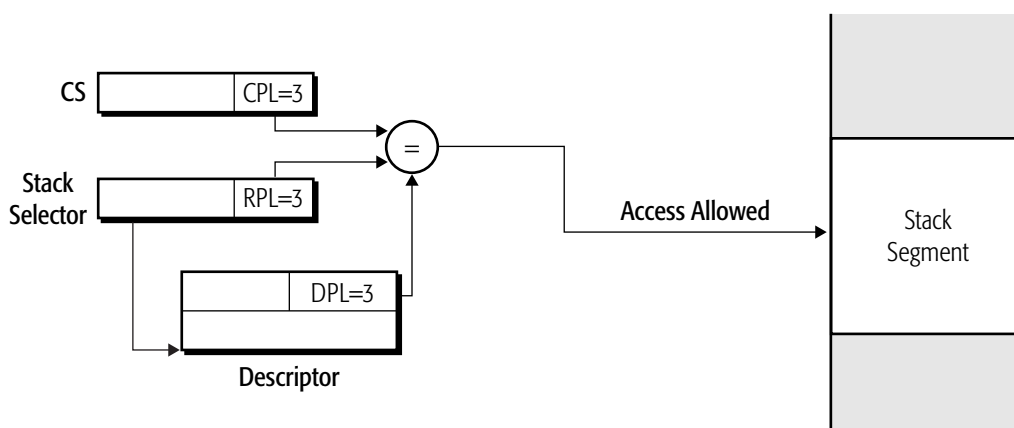

Example 1: Privilege Check Passes

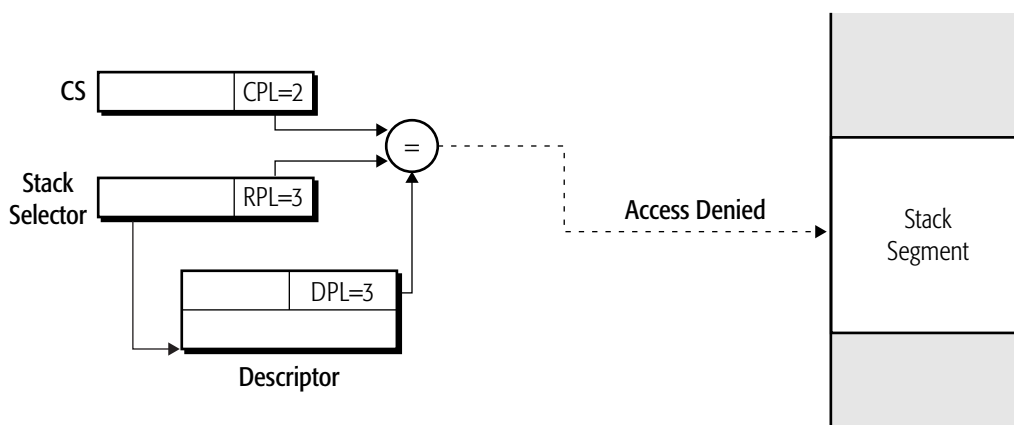

Example 2: Privilege Check Fails

513-235.eps

Figure 4-27. Stack-Access Privilege-Check Examples

4.11 Control-Transfer Privilege Checks

Control transfers between code segments (also called *far control transfers*) cause the processor to perform privilege checks to determine whether the source program is allowed to transfer control to the target program. If the privilege checks pass, access to the target code-segment is granted. When access is granted, the target code-segment selector is loaded into the CS register. The rIP register is updated with the target CS offset taken from either the far-pointer operand or the gate descriptor. Privilege checks are not performed during *near control transfers* because such transfers do not change segments.

The following mechanisms can be used by software to perform far control transfers:

- System-software control transfers using the *system-call* and *system-return* instructions. See “SYSCALL and SYSRET” on page 150 and “SYSENTER and SYSEXIT (Legacy Mode Only)” on page 152 for more information on these instructions. SYSCALL and SYSRET are the preferred method of performing control transfers in long mode. *SYSENTER and SYSEXIT are not supported in long mode.*
- Direct control transfers using CALL and JMP instructions. These are discussed in the next section, “Direct Control Transfers.”
- Call-gate control transfers using CALL and JMP instructions. These are discussed in “Control Transfers Through Call Gates” on page 102.
- Return control transfers using the RET instruction. These are discussed in “Return Control Transfers” on page 109.
- Interrupts and exceptions, including the INT_n and IRET instructions. These are discussed in Chapter 8, “Exceptions and Interrupts.”
- Task switches initiated by CALL and JMP instructions. Task switches are discussed in Chapter 12, “Task Management.” *The hardware task-switch mechanism is not supported in long mode.*

4.11.1 Direct Control Transfers

A *direct control transfer* occurs when software executes a far-CALL or a far-JMP instruction without using a call gate. The privilege checks and type of access allowed as a result of a direct control transfer depends on whether the target code segment is conforming or nonconforming. The code-segment-descriptor conforming (C) bit indicates whether or not the target code-segment is conforming (see “Conforming (C) Bit” on page 80 for more information on the conforming bit).

Privilege levels are not changed as a result of a direct control transfer. Program stacks are not automatically switched by the processor as they are with privilege-changing control transfers through call gates (see “Stack Switching” on page 106 for more information on automatic stack switching during privilege-changing control transfers).

Nonconforming Code Segments. Software can perform a direct control transfer to a nonconforming code segment only if the target code-segment descriptor DPL and the CPL are equal and the RPL is less than or equal to the CPL. Software must use a call gate to transfer control to a

more-privileged, nonconforming code segment (see “Control Transfers Through Call Gates” on page 102 for more information).

In far calls and jumps, the far pointer (CS:rIP) references the target code-segment descriptor. Before loading the CS register with a nonconforming code-segment selector, the processor checks as follows to see if access is allowed:

1. *DPL = CPL Check*—The processor compares the target code-segment descriptor DPL with the currently executing program CPL. If they are equal, the processor performs the next check. If they are not equal, a general-protection exception (#GP) occurs.
2. *RPL ≤ CPL Check*—The processor compares the target code-segment selector RPL with the currently executing program CPL. If the RPL is less than or equal to the CPL, access is allowed. If the RPL is greater than the CPL, a #GP exception occurs.

If access is allowed, the processor loads the CS and rIP registers with their new values and begins executing from the target location. The CPL is *not changed*—the target-CS selector RPL value is disregarded when the selector is loaded into the CS register.

Figure 4-28 on page 100 shows three examples of privilege checks performed as a result of a far control transfer to a nonconforming code-segment. In Example 1, access is allowed because $CPL = DPL$ and $RPL \leq CPL$. In Example 2, access is denied because $CPL \neq DPL$. In Example 3, access is denied because $RPL > CPL$.

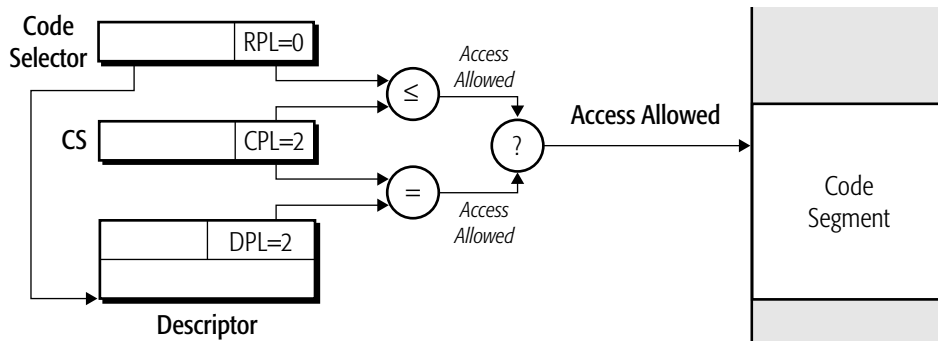

Example 1: Privilege Check Passes

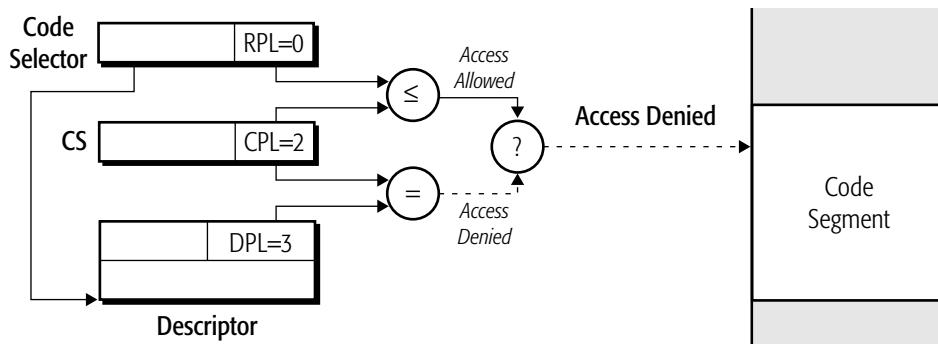

Example 2: Privilege Check Fails

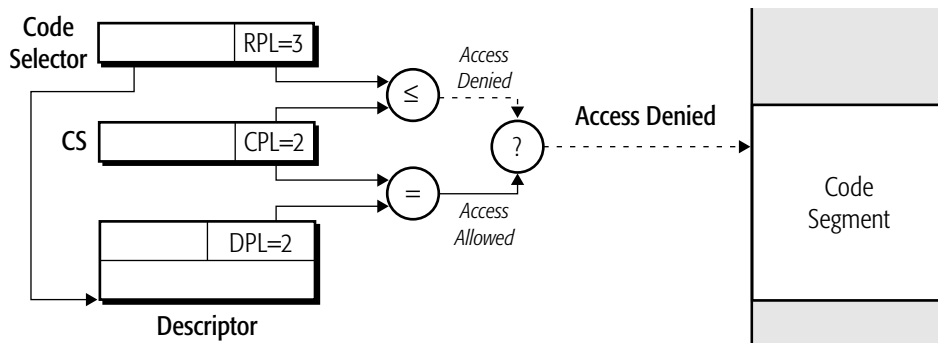

Example 3: Privilege Check Fails

513-230.eps

Figure 4-28. Nonconforming Code-Segment Privilege-Check Examples

Conforming Code Segments. On a direct control transfer to a conforming code segment, the target code-segment descriptor DPL can be lower than (at a greater privilege) the CPL. Before loading the

CS register with a conforming code-segment selector, the processor compares the target code-segment descriptor DPL with the currently-executing program CPL. If the DPL is less than or equal to the CPL, access is allowed. If the DPL is greater than the CPL, a #GP exception occurs.

On an access to a conforming code segment, the RPL is ignored and not involved in the privilege check.

When access is allowed, the processor loads the CS and rIP registers with their new values and begins executing from the target location. The CPL is *not changed*—the target CS-descriptor DPL value is disregarded when the selector is loaded into the CS register. The target program runs at the same privilege as the program that called it.

Figure 4-29 shows two examples of privilege checks performed as a result of a direct control transfer to a conforming code segment. In Example 1, access is allowed because the CPL of 3 is greater than the DPL of 0. As the target code selector is loaded into the CS register, the old CPL value of 3 replaces the target-code selector RPL value, and the target program executes with CPL=3. In Example 2, access is denied because $CPL < DPL$.

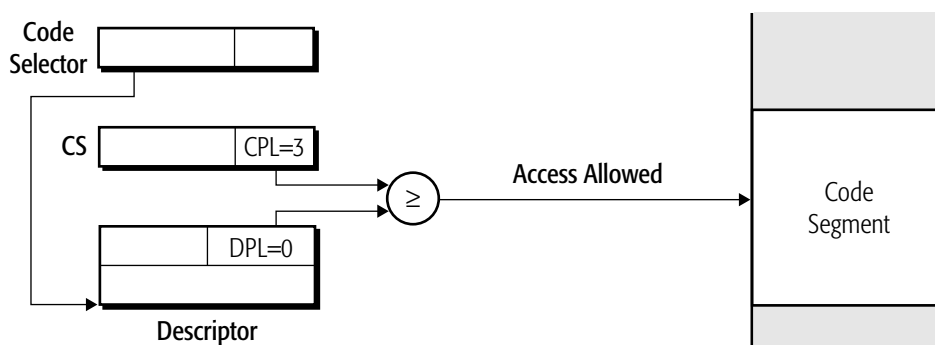

Example 1: Privilege Check Passes

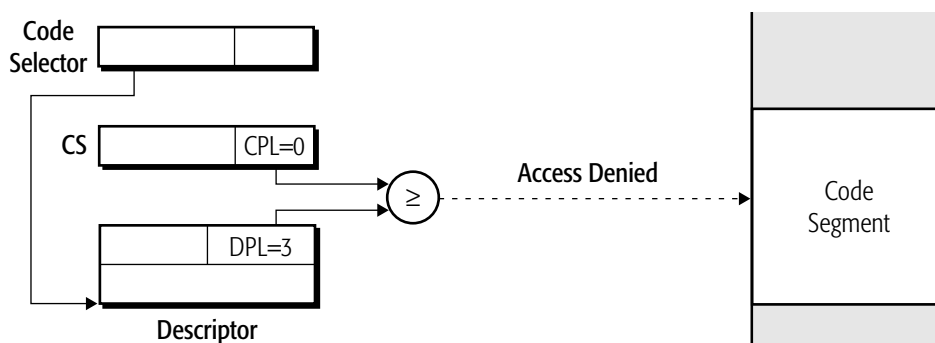

Example 2: Privilege Check Fails

513-231.eps

Figure 4-29. Conforming Code-Segment Privilege-Check Examples

4.11.2 Control Transfers Through Call Gates

Control transfers to more-privileged code segments are accomplished through the use of *call gates*. Call gates are a type of descriptor that contain pointers to code-segment descriptors and control access to those descriptors. System software uses call gates to establish protected entry points into system-service routines.

Transfer Mechanism. The pointer operand of a far-CALL or far-JMP instruction consists of two pieces: a code-segment selector (CS) and a code-segment offset (rIP). In a call-gate transfer, the CS selector points to a call-gate descriptor rather than a code-segment descriptor, and the rIP is ignored (but required by the instruction).

Figure 4-30 shows a call-gate control transfer in legacy mode. The call-gate descriptor contains segment-selector and segment-offset fields (see “Gate Descriptors” on page 84 for a detailed description of the call-gate format and fields). These two fields perform the same function as the pointer operand in a direct control-transfer instruction. The segment-selector field points to the target code-segment descriptor, and the segment-offset field is the instruction-pointer offset into the target code-segment. The code-segment base taken from the code-segment descriptor is added to the offset field in the call-gate descriptor to create the target virtual address (linear address).

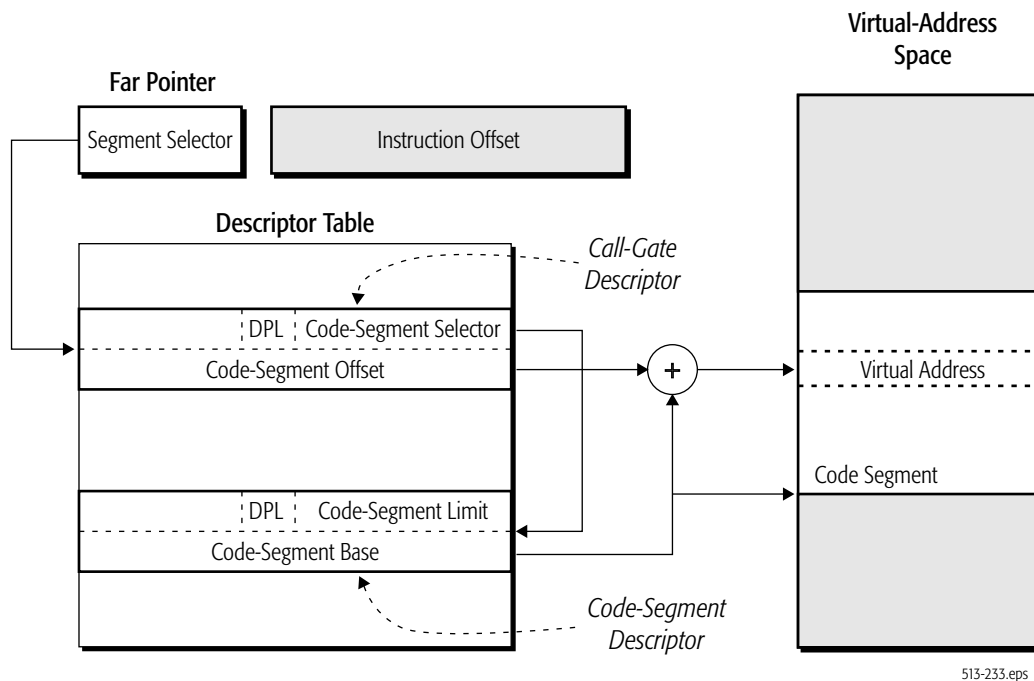
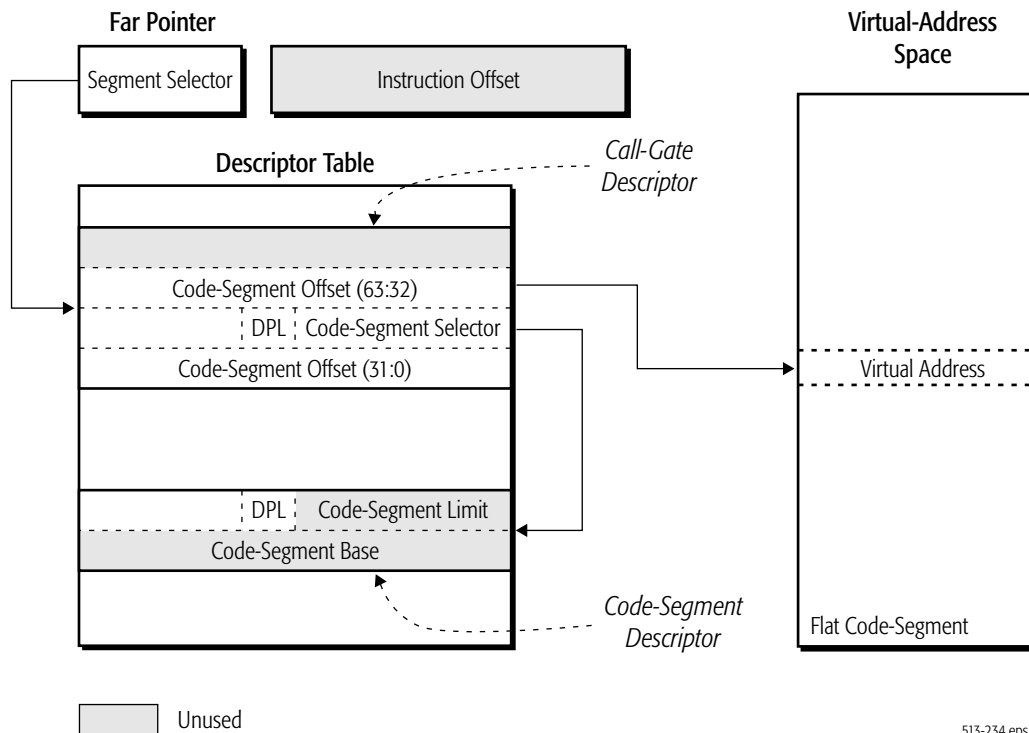

Figure 4-30. Legacy-Mode Call-Gate Transfer Mechanism

Figure 4-31 shows a call-gate control transfer in long mode. The long-mode call-gate descriptor format is expanded by 64 bits to hold a full 64-bit offset into the virtual-address space. Only long-mode call gates can be referenced in long mode (64-bit mode and compatibility mode). The legacy-mode 32-bit call-gate types are redefined in long mode as 64-bit types, and 16-bit call-gate types are illegal.



513-234.eps

Figure 4-31. Long-Mode Call-Gate Access Mechanism

A long-mode call gate must reference a 64-bit code-segment descriptor. In 64-bit mode, the code-segment descriptor base-address and limit fields are ignored. The target virtual-address is the 64-bit offset field in the expanded call-gate descriptor.

Privilege Checks. Before loading the CS register with the code-segment selector located in the call gate, the processor performs three privilege checks. The following checks are performed when either conforming or nonconforming code segments are referenced:

1. The processor compares the CPL with the call-gate DPL from the call-gate descriptor (DPL_G). The CPL must be numerically *less than or equal to* DPL_G for this check to pass. In other words, the following expression must be true: $CPL \leq DPL_G$.

2. The processor compares the RPL in the call-gate selector with DPL_G . The RPL must be numerically *less than or equal to* DPL_G for this check to pass. In other words, the following expression must be true: $RPL \leq DPL_G$.
3. The processor compares the CPL with the target code-segment DPL from the code-segment descriptor (DPL_S). The type of comparison varies depending on the type of control transfer.
 - When a call—or a jump to a *conforming* code segment—is used to transfer control through a call gate, the CPL must be numerically *greater than or equal to* DPL_S for this check to pass. (This check prevents control transfers to less-privileged programs.) In other words, the following expression must be true: $CPL \geq DPL_S$.
 - When a JMP instruction is used to transfer control through a call gate to a *nonconforming* code segment, the CPL must be numerically *equal to* DPL_S for this check to pass. (JMP instructions cannot change CPL.) In other words, the following expression must be true: $CPL = DPL_S$.

Figure 4-32 on page 105 shows two examples of call-gate privilege checks. In Example 1, all privilege checks pass as follows:

- The call-gate DPL (DPL_G) is at the lowest privilege (3), specifying that software running at any privilege level (CPL) can access the gate.
- The selector referencing the call gate passes its privilege check because the RPL is numerically less than or equal to DPL_G .
- The target code segment is at the highest privilege level ($DPL_S = 0$). This means software running at any privilege level can access the target code segment through the call gate.

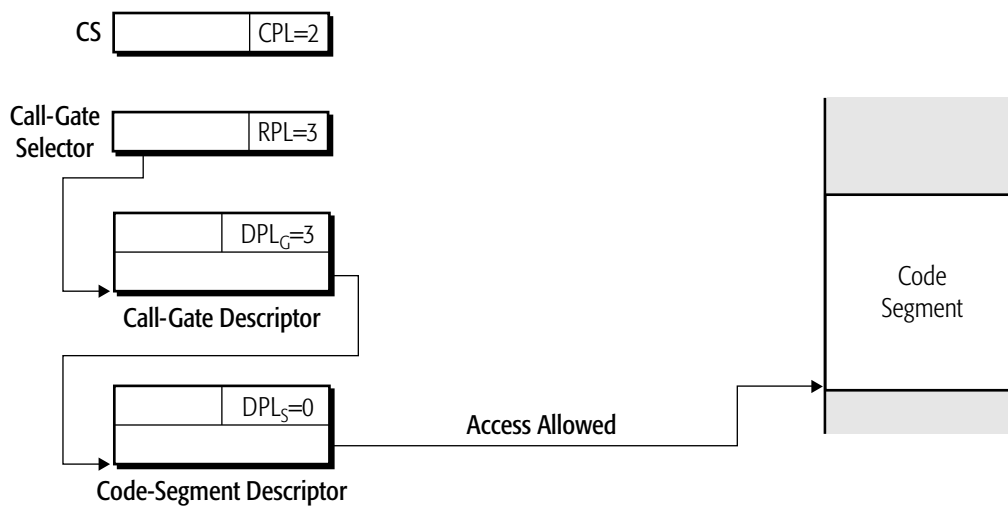

Example 1: Privilege Check Passes

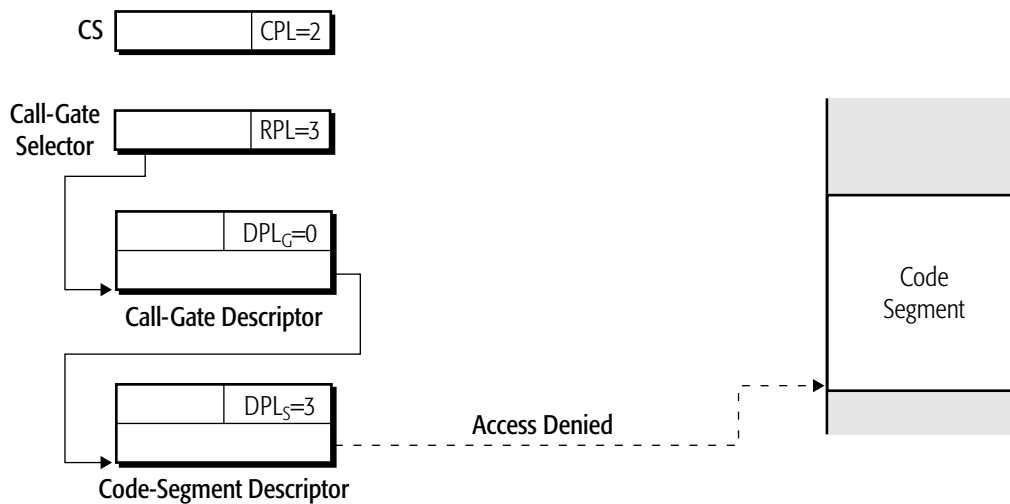

Example 2: Privilege Check Fails

513-232.eps

Figure 4-32. Privilege-Check Examples for Call Gates

In Example 2, all privilege checks fail as follows:

- The call-gate DPL (DPL_G) specifies that only software at privilege-level 0 can access the gate. The current program does not have enough privilege to access the call gate because its CPL is 2.
- The selector referencing the call-gate descriptor does not have enough privilege to complete the reference. Its RPL is numerically greater than DPL_G.

- The target code segment is at a lower privilege ($DPL_S = 3$) than the currently running software ($CPL = 2$). Transitions from more-privileged software to less-privileged software are not allowed, so this privilege check fails as well.

Although all three privilege checks failed in Example 2, failing only one check is sufficient to deny access into the target code segment.

Stack Switching. The processor performs an automatic stack switch when a control transfer causes a change in privilege levels to occur. Switching stacks isolates more-privileged software stacks from less-privileged software stacks and provides a mechanism for saving the return pointer back to the program that initiated the call.

When switching to more-privileged software, as is done when transferring control using a call gate, the processor uses the corresponding stack pointer (privilege-level 0, 1, or 2) stored in the task-state segment (TSS). The format of the stack pointer stored in the TSS depends on the system-software operating mode:

- Legacy-mode system software stores a 32-bit ESP value (stack offset) and 16-bit SS selector register value in the TSS for each of three privilege levels 0, 1, and 2.
- Long-mode system software stores a 64-bit RSP value in the TSS for privilege levels 0, 1, and 2. No SS register value is stored in the TSS because in long mode a call gate *must* reference a 64-bit code-segment descriptor. 64-bit mode does not use segmentation, and the stack pointer consists solely of the 64-bit RSP. Any value loaded in the SS register is ignored.

See “Task-Management Resources” on page 308 for more information on the legacy-mode and long-mode TSS formats.

Figure 4-33 on page 107 shows a 32-bit stack in legacy mode before and after the automatic stack switch. This particular example assumes that parameters are passed from the current program to the target program. The process followed by legacy mode in switching stacks and copying parameters is:

1. The target code-segment DPL is read by the processor and used as an index into the TSS for selecting the new stack pointer (SS:ESP). For example, if $DPL=1$ the processor selects the SS:ESP for privilege-level 1 from the TSS.
2. The SS and ESP registers are loaded with the new SS:ESP values read from the TSS.
3. The old values of the SS and ESP registers are pushed onto the stack pointed to by the new SS:ESP.
4. The 5-bit count field is read from the call-gate descriptor.
5. The number of parameters specified in the count field (up to 31) are copied from the old stack to the new stack. The size of the parameters copied by the processor depends on the call-gate size: 32-bit call gates copy 4-byte parameters and 16-bit call gates copy 2-byte parameters.
6. The return pointer is pushed onto the stack. The return pointer consists of the current CS-register value and the EIP of the instruction following the calling instruction.

7. The CS register is loaded from the segment-selector field in the call-gate descriptor, and the EIP is loaded from the offset field in the call-gate descriptor.
8. The target program begins executing with the instruction referenced by new CS:EIP.

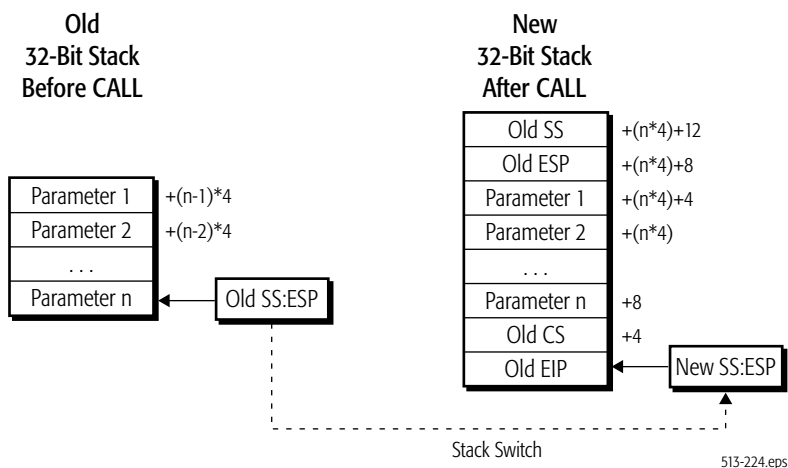

Figure 4-33. Legacy-Mode 32-Bit Stack Switch, with Parameters

Figure 4-34 shows a 32-bit stack in legacy mode before and after the automatic stack switch when no parameters are passed (count=0). Most software does not use the call-gate descriptor count-field to pass parameters. System software typically defines linkage mechanisms that do not rely on automatic parameter copying.

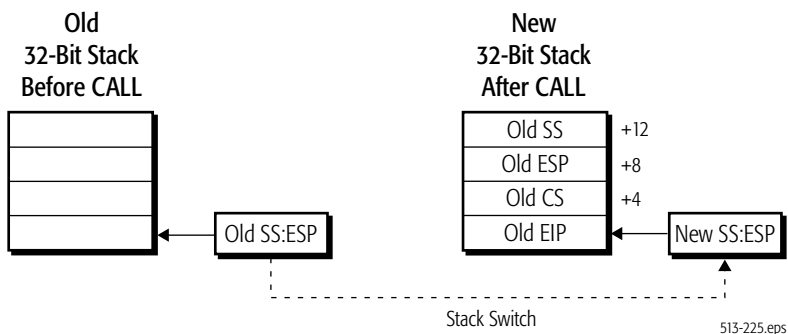

Figure 4-34. 32-Bit Stack Switch, No Parameters—Legacy Mode

Figure 4-35 on page 108 shows a long-mode stack switch. In long mode, all call gates *must* reference 64-bit code-segment descriptors, so a long-mode stack switch uses a 64-bit stack. The process of

switching stacks in long mode is similar to switching in legacy mode when no parameters are passed. The process is as follows:

1. The target code-segment DPL is read by the processor and used as an index into the 64-bit TSS for selecting the new stack pointer (RSP).
2. The RSP register is loaded with the new RSP value read from the TSS. The SS register is loaded with a null selector (SS=0). Setting the new SS selector to null allows proper handling of nested control transfers in 64-bit mode. See “Nested Returns to 64-Bit Mode Procedures” on page 110 for additional information.

As in legacy mode, it is desirable to keep the stack-segment requestor privilege-level (SS.RPL) equal to the current privilege-level (CPL). When using a call gate to change privilege levels, the SS.RPL is updated to reflect the new CPL. The SS.RPL is restored from the return-target CS.RPL on the subsequent privilege-level-changing far return.

3. The old values of the SS and RSP registers are pushed onto the stack pointed to by the new RSP. The old SS value is popped on a subsequent far return. This allows system software to set up the SS selector for a compatibility-mode process by executing a RET (or IRET) that changes the privilege level.
4. The return pointer is pushed onto the stack. The return pointer consists of the current CS-register value and the RIP of the instruction following the calling instruction.
5. The CS register is loaded from the segment-selector field in the long-mode call-gate descriptor, and the RIP is loaded from the offset field in the long-mode call-gate descriptor.

The target program begins execution with the instruction referenced by the new RIP.

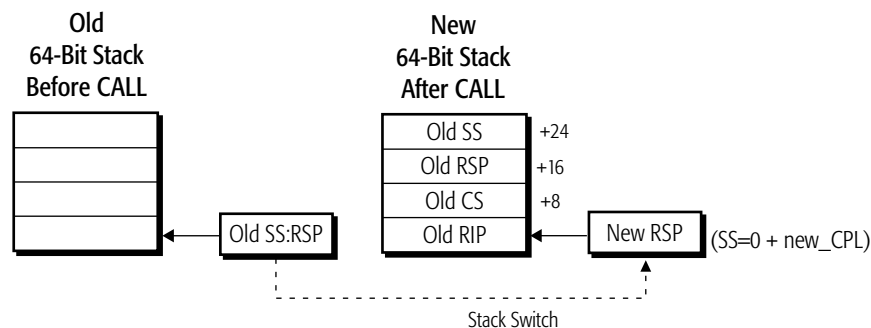

Figure 4-35. Stack Switch—Long Mode

All long-mode stack pushes resulting from a privilege-level-changing far call are eight-bytes wide and increment the RSP by eight. Long mode ignores the call-gate count field and does not support the automatic parameter-copy feature found in legacy mode. Software can access parameters on the old stack, if necessary, by referencing the old stack segment selector and stack pointer saved on the new process stack.

4.11.3 Return Control Transfers

Returns to calling programs can be performed by using the RET instruction. The following types of returns are possible:

- *Near Return*—Near returns perform control transfers within the same code segment, so the CS register is unchanged. The new offset is popped off the stack and into the rIP register. No privilege checks are performed.
- *Far Return, Same Privilege*—A far return transfers control from one code segment to another. When the original code segment is at the same privilege level as the target code segment, a far pointer (CS:rIP) is popped off the stack and the RPL of the new code segment (CS) is checked. If the requested privilege level (RPL) matches the current privilege level (CPL), then a return is made to the same privilege level. This prevents software from changing the CS value on the stack in an attempt to return to higher-privilege software.
- *Far Return, Less Privilege*—Far returns can change privilege levels, but only to a *lower*-privilege level. In this case a stack switch is performed between the current, higher-privilege program and the lower-privilege return program. The CS-register and rIP-register values are popped off the stack. The lower-privilege stack pointer is also popped off the stack and into the SS register and rSP register. The processor checks both the CS and SS privilege levels to ensure they are equal and at a lesser privilege than the current CS.

In the case of nested returns to 64-bit mode, a null selector can be popped into the SS register. See “Nested Returns to 64-Bit Mode Procedures” on page 110.

Far returns also check the privilege levels of the DS, ES, FS and GS selector registers. If any of these segment registers have a selector with a higher privilege than the return program, the segment register is loaded with the null selector.

Stack Switching. The stack switch performed by a far return to a lower-privilege level reverses the stack switch of a call gate to a higher-privilege level, except that parameters are never automatically copied as part of a return. The process followed by a far-return stack switch in long mode and legacy mode is:

1. The return code-segment RPL is read by the processor from the CS value stored on the stack to determine that a lower-privilege control transfer is occurring.
2. The return-program instruction pointer is popped off the current-program (higher privilege) stack and loaded into the CS and rIP registers.
3. The return instruction can include an immediate operand that specifies the number of additional bytes to be popped off of the stack. These bytes may correspond to the parameters pushed onto the stack previously by a call through a call gate containing a non-zero parameter-count field. If the return includes the immediate operand, then the stack pointer is adjusted upward by adding the specified number of bytes to the rSP.
4. The return-program stack pointer is popped off the current-program (higher privilege) stack and loaded into the SS and rSP registers. In the case of nested returns to 64-bit mode, a null selector can be popped into the SS register.

The operand size of a far return determines the size of stack pops when switching stacks. If a far return is used in 64-bit mode to return from a prior call through a long-mode call gate, the far return must use a 64-bit operand size. The 64-bit operand size allows the far return to properly read the stack established previously by the far call.

Nested Returns to 64-Bit Mode Procedures. In long mode, a far call that changes privilege levels causes the SS register to be loaded with a null selector (this is the same action taken by an interrupt in long mode). If the called procedure performs another far call to a higher-privileged procedure, or is interrupted, the null SS selector is pushed onto the stack frame, and another null selector is loaded into the SS register. Using a null selector in this way allows the processor to properly handle returns nested within 64-bit-mode procedures and interrupt handlers.

Normally, a RET that pops a null selector into the SS register causes a general-protection exception (#GP) to occur. However, in long mode, the null selector acts as a flag indicating the existence of nested interrupt handlers or other privileged software in 64-bit mode. Long mode allows RET to pop a null selector into SS from the stack under the following conditions:

- The target mode is 64-bit mode.
- The target CPL is less than 3.

In this case, the processor does not load an SS descriptor, and the null selector is loaded into SS without causing a #GP exception.

4.12 Limit Checks

Except in 64-bit mode, limit checks are performed by all instructions that reference memory. Limit checks detect attempts to access memory outside the current segment boundary, attempts at executing instructions outside the current code segment, and indexing outside the current descriptor table. If an instruction fails a limit check, either (1) a general-protection exception occurs for all other segment-limit violations or (2) a stack-fault exception occurs for stack-segment limit violations.

In 64-bit mode, segment limits are *not checked* during accesses to any segment referenced by the CS, DS, ES, FS, GS, and SS selector registers. Instead, the processor checks that the virtual addresses used to reference memory are in canonical-address form. In 64-bit mode, as with legacy mode and compatibility mode, descriptor-table limits *are checked*.

4.12.1 Determining Limit Violations

To determine segment-limit violations, the processor checks a virtual (linear) address to see if it falls outside the valid range of segment offsets determined by the segment-limit field in the descriptor. If any part of an operand or instruction falls outside the segment-offset range, a limit violation occurs. For example, a doubleword access, two bytes from an upper segment boundary, causes a segment violation because half of the doubleword is outside the segment.

Three bits from the descriptor entry are used to control how the segment-limit field is interpreted: the granularity (G) bit, the default operand-size (D) bit, and for data segments, the expand-down (E) bit. See “Legacy Segment Descriptors” on page 77 for a detailed description of each bit.

For all segments other than expand-down segments, the minimum segment-offset is 0. The maximum segment-offset depends on the value of the G bit:

- If G=0 (byte granularity), the maximum allowable segment-offset is equal to the value of the segment-limit field.
- If G=1 (4096-byte granularity), the segment-limit field is first scaled by 4096 (1000h). Then 4095 (0FFFh) is added to the scaled value to arrive at the maximum allowable segment-offset, as shown in the following equation:

$$\text{maximum segment-offset} = (\text{limit} \times 1000\text{h}) + 0\text{FFFh}$$

For example, if the segment-limit field is 0100h, then the maximum allowable segment-offset is $(0100\text{h} \times 1000\text{h}) + 0\text{FFFh} = 10_1\text{FFFh}$.

In both cases, the maximum segment-size is specified when the descriptor segment-limit field is 0F_FFFFh.

Expand-Down Segments. Expand-down data segments are supported in legacy mode and compatibility mode but not in 64-bit mode. With expand-down data segments, the maximum segment offset depends on the value of the D bit in the data-segment descriptor:

- If D=0 the maximum segment-offset is 0_FFFFh.
- If D=1 the maximum segment-offset is 0_FFFF_FFFFh.

The minimum allowable segment offset in expand-down segments depends on the value of the G bit:

- If G=0 (byte granularity), the minimum allowable segment offset is the segment-limit value plus 1. For example, if the segment-limit field is 0100h, then the minimum allowable segment-offset is 0101h.
- If G=1 (4096-byte granularity), the segment-limit value in the descriptor is first scaled by 4096 (1000h), and then 4095 (0FFFh) is added to the scaled value to arrive at a scaled segment-limit value. The minimum allowable segment-offset is this scaled segment-limit value plus 1, as shown in the following equation:

$$\text{minimum segment-offset} = (\text{limit} \times 1000) + 0\text{FFFh} + 1$$

For example, if the segment-limit field is 0100h, then the minimum allowable segment-offset is $(0100\text{h} \times 1000\text{h}) + 0\text{FFFh} + 1 = 10_1000\text{h}$.

For expand-down segments, the maximum segment size is specified when the segment-limit value is 0.

4.13 Type Checks

Type checks prevent software from using descriptors in invalid ways. Failing a type check results in an exception. Type checks are performed using five bits from the descriptor entry: the S bit and the 4-bit Type field. Together, these five bits are used to specify the descriptor type (code, data, segment, or gate) and its access characteristics. See “Legacy Segment Descriptors” on page 77 for a detailed description of the S bit and Type-field encodings. Type checks are performed by the processor in compatibility mode as well as legacy mode. Limited type checks are performed in 64-bit mode.

4.13.1 Type Checks in Legacy and Compatibility Modes

The type checks performed in legacy mode and compatibility mode are listed in the following sections.

Descriptor-Table Register Loads. Loads into the LDTR and TR descriptor-table registers are checked for the appropriate system-segment type. The LDTR can only be loaded with an LDT descriptor, and the TR only with a TSS descriptor. The checks are performed during any action that causes these registers to be loaded. This includes execution of the LLDT and LTR instructions and during task switches.

Segment Register Loads. The following restrictions are placed on the segment-descriptor types that can be loaded into the six user segment registers:

- Only code segments can be loaded into the CS register.
- Only writable data segments can be loaded into the SS register.
- Only the following segment types can be loaded into the DS, ES, FS, or GS registers:
 - Read-only or read/write data segments.
 - Readable code segments.

These checks are performed during any action that causes the segment registers to be loaded. This includes execution of the MOV segment-register instructions, control transfers, and task switches.

Control Transfers. Control transfers (branches and interrupts) place additional restrictions on the segment types that can be referenced during the transfer:

- The segment-descriptor type referenced by far CALLs and far JMPs must be one of the following:
 - A code segment
 - A call gate or a task gate
 - An available TSS (only allowed in legacy mode)
 - A task gate (only allowed in legacy mode)
- Only code-segment descriptors can be referenced by call-gate, interrupt-gate, and trap-gate descriptors.
- Only TSS descriptors can be referenced by task-gate descriptors.
- The link field (selector) in the TSS can only point to a TSS descriptor. This is checked during an IRET control transfer to a task.

- The far RET and far IRET instructions can only reference code-segment descriptors.
- The interrupt-descriptor table (IDT), which is referenced during interrupt control transfers, can only contain interrupt gates, trap gates, and task gates.

Segment Access. After a segment descriptor is successfully loaded into one of the segment registers, reads and writes into the segments are restricted in the following ways:

- Writes are not allowed into read-only data-segment types.
- Writes are not allowed into code-segment types (executable segments).
- Reads from code-segment types are not allowed if the readable (R) type bit is cleared to 0.

These checks are generally performed during execution of instructions that access memory.

4.13.2 Long Mode Type Check Differences

Compatibility Mode and 64-Bit Mode. The following type checks differ in long mode (64-bit mode and compatibility mode) as compared to legacy mode:

- *System Segments*—System-segment types are checked, but the following types that are valid in legacy mode are illegal in long mode:
 - 16-bit available TSS.
 - 16-bit busy TSS.
 - Type-field encoding of 00h in the upper half of a system-segment descriptor to indicate an illegal type and prevent access as a legacy descriptor.
- *Gates*—Gate-descriptor types are checked, but the following types that are valid in legacy mode are illegal in long mode:
 - 16-bit call gate.
 - 16-bit interrupt gate.
 - 16-bit trap gate.
 - Task gate.

64-Bit Mode. 64-bit mode disables segmentation, and most of the segment-descriptor fields are ignored. The following list identifies situations where type checks in 64-bit mode differ from those in compatibility mode and legacy mode:

- *Code Segments*—The readable (R) type bit is ignored in 64-bit mode. None of the legacy type-checks that prevent reads from or writes into code segments are performed in 64-bit mode.
- *Data Segments*—Data-segment type attributes are ignored in 64-bit mode. The writable (W) and expand-down (E) type bits are ignored. All data segments are treated as writable.

5 Page Translation and Protection

The x86 page-translation mechanism (or simply *paging mechanism*) enables system software to create separate address spaces for each process or application. These address spaces are known as *virtual-address* spaces. System software uses the paging mechanism to selectively map individual pages of physical memory into the virtual-address space using a set of hierarchical address-translation tables known collectively as *page tables*.

The paging mechanism and the page tables are used to provide each process with its own private region of physical memory for storing its code and data. Processes can be protected from each other by isolating them within the virtual-address space. A process cannot access physical memory that is not mapped into its virtual-address space by system software.

System software can use the paging mechanism to selectively map physical-memory pages into multiple virtual-address spaces. Mapping physical pages in this manner allows them to be shared by multiple processes and applications. The physical pages can be configured by the page tables to allow read-only access. This prevents applications from altering the pages and ensures their integrity for use by all applications.

Shared mapping is typically used to allow access of shared-library routines by multiple applications. A read-only copy of the library routine is mapped to each application virtual-address space, but only a single copy of the library routine is present in physical memory. This capability also allows a copy of the operating-system kernel and various device drivers to reside within the application address space. Applications are provided with efficient access to system services without requiring costly address-space switches.

The system-software portion of the address space necessarily includes system-only data areas that must be protected from accesses by applications. System software uses the page tables to protect this memory by designating the pages as *supervisor* pages. Such pages are only accessible by system software.

Finally, system software can use the paging mechanism to map multiple, large virtual-address spaces into a much smaller amount of physical memory. Each application can use the entire 32-bit or 64-bit virtual-address space. System software actively maps the most-frequently-used virtual-memory pages into the available pool of physical-memory pages. The least-frequently-used virtual-memory pages are swapped out to the hard drive. This process is known as *demand-paged virtual memory*.

5.1 Page Translation Overview

The x86 architecture provides support for translating 32-bit virtual addresses into 32-bit physical addresses (larger physical addresses, such as 36-bit or 40-bit addresses, are supported as a special mode). The AMD64 architecture enhances this support to allow translation of 64-bit virtual addresses into 52-bit physical addresses, although processor implementations can support smaller virtual-address and physical-address spaces.

Virtual addresses are translated to physical addresses through hierarchical translation tables created and managed by system software. Each table contains a set of entries that point to the next-lower table in the translation hierarchy. A single table at one level of the hierarchy can have hundreds of entries, each of which points to a unique table at the next-lower hierarchical level. Each lower-level table can in turn have hundreds of entries pointing to tables further down the hierarchy. The lowest-level table in the hierarchy points to the translated physical page.

Figure 5-1 on page 117 shows an overview of the page-translation hierarchy used in long mode. Legacy mode paging uses a subset of this translation hierarchy (the page-map level-4 table does not exist in legacy mode and the PDP table may or may not be used, depending on which paging mode is enabled). As this figure shows, a virtual address is divided into fields, each of which is used as an offset into a translation table. The complete translation chain is made up of all table entries referenced by the virtual-address fields. The lowest-order virtual-address bits are used as the byte offset into the physical page.

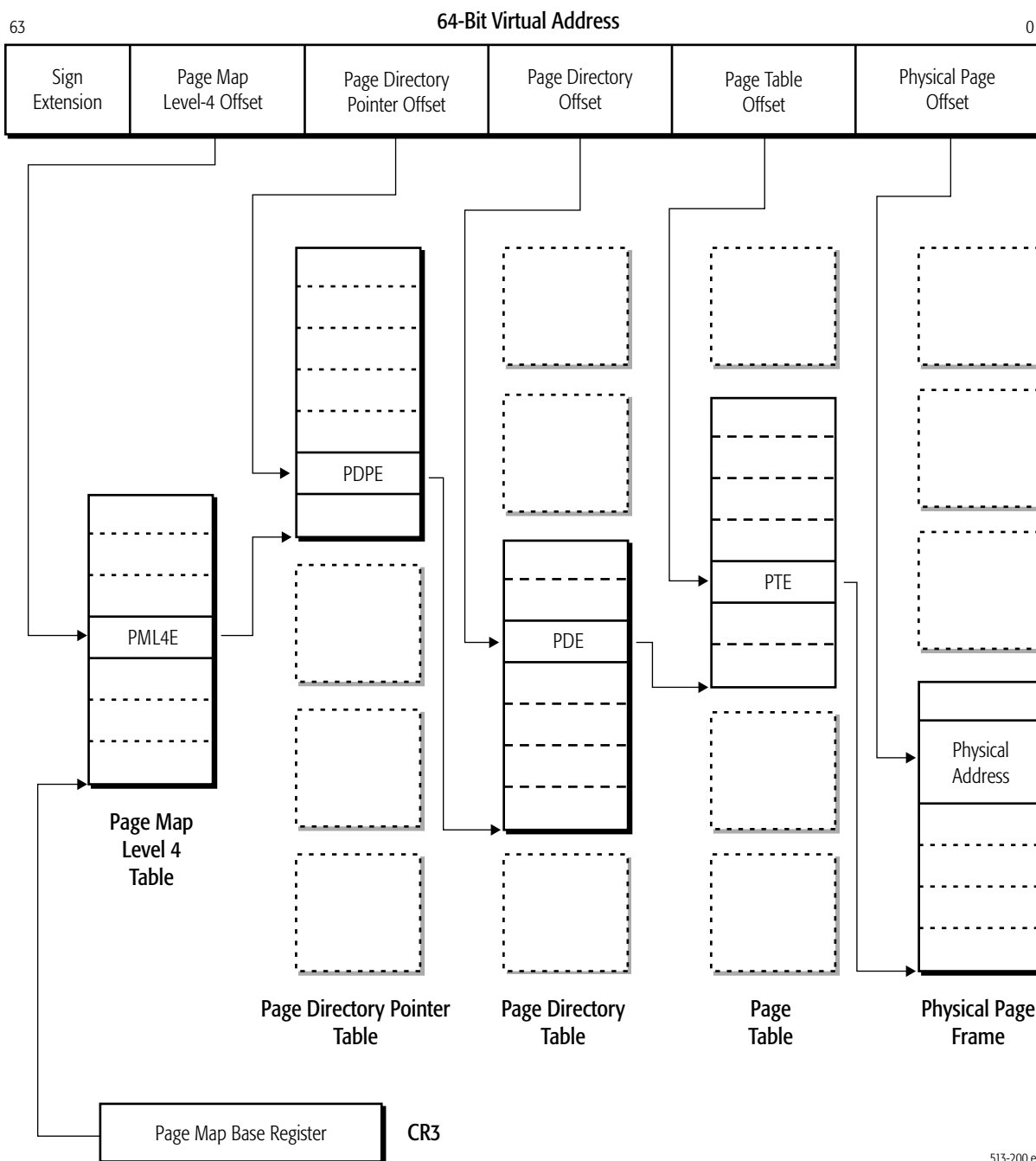

Figure 5-1. Virtual to Physical Address Translation—Long Mode

Legacy page translation offers a variety of alternatives in translating virtual addresses to physical addresses. Four physical-page sizes of 4 Kbytes, 2 Mbytes and 4 Mbytes are available. Virtual

addresses are 32 bits long, and physical addresses up to the supported physical-address size can be used. The AMD64 architecture enhances the legacy translation support by allowing virtual addresses of up to 64 bits long to be translated into physical addresses of up to 52 bits long.

Currently, the AMD64 architecture defines a mechanism for translating 48-bit virtual addresses to 52-bit physical addresses. The mechanism used to translate a full 64-bit virtual address is reserved and will be described in a future AMD64 architectural specification.

5.1.1 Page-Translation Options

The form of page-translation support available to software depends on which paging features are enabled. Four controls are available for selecting the various paging alternatives:

- Page-Translation Enable (CR0.PG)
- Physical-Address Extensions (CR4.PAE)
- Page-Size Extensions (CR4.PSE)
- Long-Mode Active (EFER.LMA)

Not all paging alternatives are available in all modes. Table 5-1 summarizes the paging support available in each mode.

Table 5-1. Supported Paging Alternatives (CR0.PG=1)

Mode		Physical-Address Extensions (CR4.PAE)	Page-Size Extensions (CR4.PSE)	Page-Directory Pointer Offset	Page-Directory Page Size	Resulting Physical-Page Size	Maximum Virtual Address	Maximum Physical Address	
Long Mode	64-Bit Mode	Enabled	–	PDPE.PS=0	PDE.PS=0	4 Kbyte	64-bit	52-bit	
	Compatibility Mode				PDE.PS=1	2 Mbyte			
					–	1 Gbyte			
Legacy Mode		Enabled	–	PDPE.PS=0	PDE.PS=0	4 Kbyte	32-bit	52-bit	
						PDE.PS=1		2 Mbyte	52-bit
		Disabled			Disabled	–		4 Kbyte	32-bit
					Enabled	PDE.PS=0		4 Kbyte	32-bit
						PDE.PS=1		4 Mbyte	40-bit

5.1.2 Page-Translation Enable (PG) Bit

Page translation is controlled by the PG bit in CR0 (bit 31). When CR0.PG is set to 1, page translation is enabled. When CR0.PG is cleared to 0, page translation is disabled.

The AMD64 architecture uses CR0.PG to activate and deactivate long mode when long mode is enabled. See “Enabling and Activating Long Mode” on page 358 for more information.

5.1.3 Physical-Address Extensions (PAE) Bit

Physical-address extensions are controlled by the PAE bit in CR4 (bit 5). When CR4.PAE is set to 1, physical-address extensions are enabled. When CR4.PAE is cleared to 0, physical-address extensions are disabled.

Setting CR4.PAE=1 enables virtual addresses to be translated into physical addresses up to 52 bits long. This is accomplished by doubling the size of paging data-structure entries from 32 bits to 64 bits to accommodate the larger physical base-addresses for physical-pages.

PAE must be enabled before activating long mode. See “Enabling and Activating Long Mode” on page 358.

5.1.4 Page-Size Extensions (PSE) Bit

Page-size extensions are controlled by the PSE bit in CR4 (bit 4). Setting CR4.PSE to 1 allows operating-system software to use 4-Mbyte physical pages in the translation process. The 4-Mbyte physical pages can be mixed with standard 4-Kbyte physical pages or replace them entirely. The selection of physical-page size is made on a page-directory-entry basis. See “Page Size (PS) Bit” on page 137 for more information on physical-page size selection. When CR4.PSE is cleared to 0, page-size extensions are disabled.

The choice of 2 Mbyte or 4 Mbyte as the large physical-page size depends on the value of CR4.PSE and CR4.PAE, as follows:

- If physical-address extensions are enabled (CR4.PAE=1), the large physical-page size is 2 Mbytes, regardless of the value of CR4.PSE.
- If physical-address extensions are disabled (CR4.PAE=0) *and* CR4.PSE=1, the large physical-page size is 4 Mbytes.
- If both CR4.PAE=0 and CR4.PSE=0, the only available page size is 4 Kbytes.

The value of CR4.PSE is ignored when long mode is active. This is because physical-address extensions must be enabled in long mode, and the only available page sizes are 4 Kbytes and 2 Mbytes.

In legacy mode, physical addresses up to 40 bits long can be translated from 32-bit virtual addresses using 32-bit paging data-structure entries when 4-Mbyte physical-page sizes are selected. In this special case, CR4.PSE=1 and CR4.PAE=0. See “4-Mbyte Page Translation” on page 123 for a description of the 4-Mbyte PDE that supports 40-bit physical-address translation. The 40-bit physical-address capability is an AMD64 architecture enhancement over the similar capability available in the legacy x86 architecture.

5.1.5 Page-Directory Page Size (PS) Bit

The page directory offset entry (PDE) and page directory pointer offset entry (PDPE) are data structures used in page translation (see Figure 5-1 on page 117). The page-size (PS) bit in the PDE (bit 7, referred to as PDE.PS) selects between standard 4-Kbyte physical-page sizes and larger (2-Mbyte or

4-Mbyte) physical-page sizes. The page-size (also PS) bit in the PDPE (bit 7, referred to as PDPE.PS) selects between 2-Mbyte and 1-Gbyte physical-page sizes in long mode.

When PDE.PS is set to 1, large physical pages are used, and the PDE becomes the lowest level of the translation hierarchy. The size of the large page is determined by the values of CR4.PAE and CR4.PSE, as shown in Figure 5-1 on page 118. When PDE.PS is cleared to 0, standard 4-Kbyte physical pages are used, and the PTE is the lowest level of the translation hierarchy.

When PDPE.PS is set to 1, 1-Gbyte physical pages are used, and the PDPE becomes the lowest level of the translation hierarchy. Neither the PDE nor PTE are used for 1-Gbyte paging.

5.2 Legacy-Mode Page Translation

Legacy mode supports two forms of translation:

- *Normal (non-PAE) Paging*—This is used when physical-address extensions are disabled (CR4.PAE=0). Entries in the page translation table are 32 bits and are used to translate 32-bit virtual addresses into physical addresses as large as 40 bits.
- *PAE Paging*—This is used when physical-address extensions are enabled (CR4.PAE=1). Entries in the page translation table are 64 bits and are used to translate 32-bit virtual addresses into physical addresses as large as 52 bits.

Legacy paging uses up to three levels of page-translation tables, depending on the paging form used and the physical-page size. Entries within each table are selected using virtual-address bit fields. The legacy page-translation tables are:

- *Page Table*—Each page-table entry (PTE) points to a physical page. If 4-Kbyte pages are used, the page table is the lowest level of the page-translation hierarchy. PTEs are not used when translating 2-Mbyte or 4-Mbyte pages.
- *Page Directory*—If 4-Kbyte pages are used, each page-directory entry (PDE) points to a page table. If 2-Mbyte or 4-Mbyte pages are used, a PDE is the lowest level of the page-translation hierarchy and points to a physical page. In non-PAE paging, the page directory is the highest level of the translation hierarchy.
- *Page-Directory Pointer*—Each page-directory pointer entry (PDPE) points to a page directory. Page-directory pointers are only used in PAE paging (CR4.PAE=1), and are the highest level in the legacy page-translation hierarchy.

The translation-table-entry formats and how they are used in the various forms of legacy page translation are described beginning on page 121.

5.2.1 CR3 Register

The CR3 register is used to point to the base address of the highest-level page-translation table. The base address is either the page-directory pointer table or the page directory table. The CR3 register format depends on the form of paging being used. Figure 5-2 on page 121 shows the CR3 format when

normal (non-PAE) paging is used ($CR4.PAE=0$). Figure 5-3 shows the CR3 format when PAE paging is used ($CR4.PAE=1$).

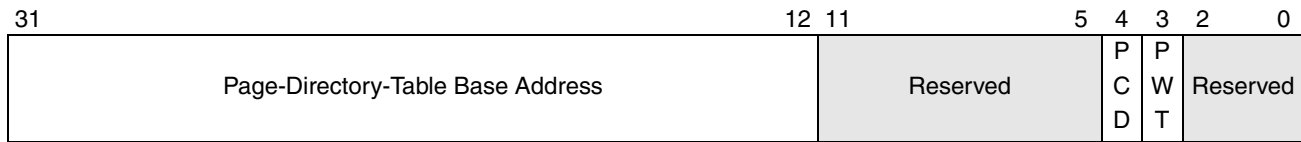

Figure 5-2. Control Register 3 (CR3)—Non-PAE Paging Legacy-Mode

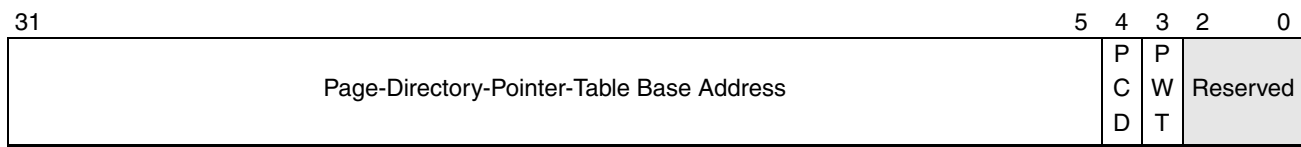

Figure 5-3. Control Register 3 (CR3)—PAE Paging Legacy-Mode

The CR3 register fields for legacy-mode paging are:

Table Base Address Field. This field points to the starting physical address of the highest-level page-translation table. The size of this field depends on the form of paging used:

- *Normal (Non-PAE) Paging ($CR4.PAE=0$)*—This 20-bit field occupies bits 31–12, and points to the base address of the page-directory table. The page-directory table is aligned on a 4-Kbyte boundary, with the low-order 12 address bits (11–0) assumed to be 0. This yields a total base-address size of 32 bits.
- *PAE Paging ($CR4.PAE=1$)*—This field is 27 bits and occupies bits 31–5. The CR3 register points to the base address of the page-directory-pointer table. The page-directory-pointer table is aligned on a 32-byte boundary, with the low 5 address bits (4–0) assumed to be 0.

Page-Level Writethrough (PWT) Bit. Bit 3. Page-level writethrough indicates whether the highest-level page-translation table has a writeback or writethrough caching policy. When $PWT=0$, the table has a writeback caching policy. When $PWT=1$, the table has a writethrough caching policy.

Page-Level Cache Disable (PCD) Bit. Bit 4. Page-level cache disable indicates whether the highest-level page-translation table is cacheable. When $PCD=0$, the table is cacheable. When $PCD=1$, the table is not cacheable.

Reserved Bits. Reserved fields should be cleared to 0 by software when writing CR3.

5.2.2 Normal (Non-PAE) Paging

Non-PAE paging ($CR4.PAE=0$) supports 4-Kbyte and 4-Mbyte physical pages, as described in the following sections.

4-Kbyte Page Translation. 4-Kbyte physical-page translation is performed by dividing the 32-bit virtual address into three fields. Each of the upper two fields are used as an index into a two-level page-translation hierarchy. The virtual-address fields are used as follows, and are shown in Figure 5-4:

- Bits 31–22 index into the 1024-entry page-directory table.
- Bits 21–12 index into the 1024-entry page table.
- Bits 11–0 provide the byte offset into the physical page.

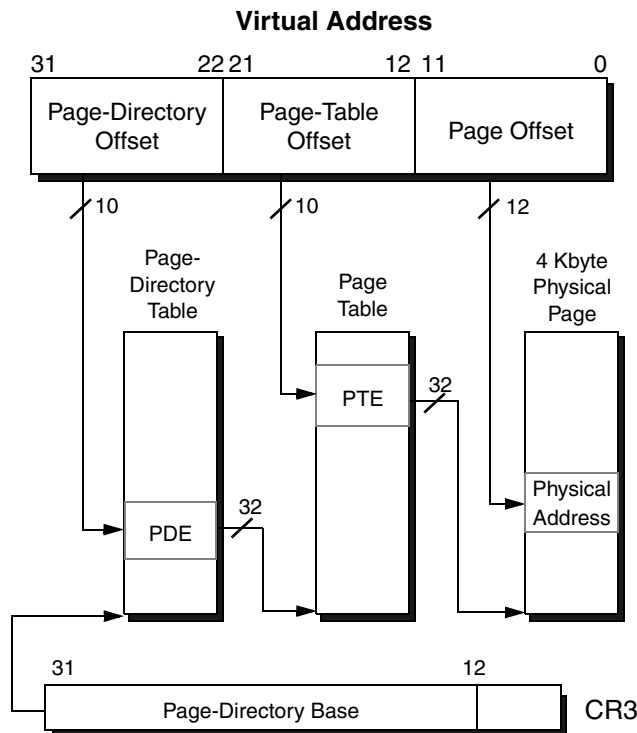

Figure 5-4. 4-Kbyte Non-PAE Page Translation—Legacy Mode

Figure 5-5 on page 123 shows the format of the PDE (page-directory entry), and Figure 5-6 on page 123 shows the format of the PTE (page-table entry). Each table occupies 4 Kbytes and can hold 1024 of the 32-bit table entries. The fields within these table entries are described in “Page-Translation-Table Entry Fields” on page 135.

Figure 5-5 shows bit 7 cleared to 0. This bit is the *page-size* bit (PS), and specifies a 4-Kbyte physical-page translation.

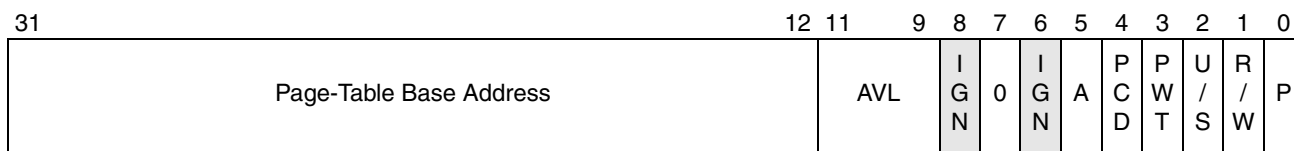

Figure 5-5. 4-Kbyte PDE—Non-PAE Paging Legacy-Mode



Figure 5-6. 4-Kbyte PTE—Non-PAE Paging Legacy-Mode

4-Mbyte Page Translation. 4-Mbyte page translation is only supported when page-size extensions are enabled (CR4.PSE=1) and physical-address extensions are disabled (CR4.PAE=0).

PSE defines a page-size bit in the 32-bit PDE format (PDE.PS). This bit is used by the processor during page translation to support both 4-Mbyte and 4-Kbyte pages. 4-Mbyte pages are selected when PDE.PS is set to 1, and the PDE points directly to a 4-Mbyte physical page. PTEs are not used in a 4-Mbyte page translation. If PDE.PS is cleared to 0, or if 4-Mbyte page translation is disabled, the PDE points to a PTE.

4-Mbyte page translation is performed by dividing the 32-bit virtual address into two fields. Each field is used as an index into a single-level page-translation hierarchy. The virtual-address fields are used as follows, and are shown in Figure 5-7 on page 124:

- Bits 31–22 index into the 1024-entry page-directory table.
- Bits 21–0 provide the byte offset into the physical page.

addresses (up to 52 bits). The size of each table remains 4 Kbytes, which means each table can hold 512 of the 64-bit entries. PAE paging also introduces a third-level page-translation table, known as the page-directory-pointer table (PDP).

The size of large pages in PAE-paging mode is 2 Mbytes rather than 4 Mbytes. PAE uses the page-directory page-size bit (PDE.PS) to allow selection between 4-Kbyte and 2-Mbyte page sizes. PAE automatically uses the page-size bit, so the value of CR4.PSE is ignored by PAE paging.

4-Kbyte Page Translation. With PAE paging, 4-Kbyte physical-page translation is performed by dividing the 32-bit virtual address into four fields, each of the upper three fields is used as an index into a 3-level page-translation hierarchy. The virtual-address fields are described as follows and are shown in Figure 5-9:

- Bits 31–30 index into a 4-entry page-directory-pointer table.
- Bits 29–21 index into the 512-entry page-directory table.
- Bits 20–12 index into the 512-entry page table.
- Bits 11–0 provide the byte offset into the physical page.

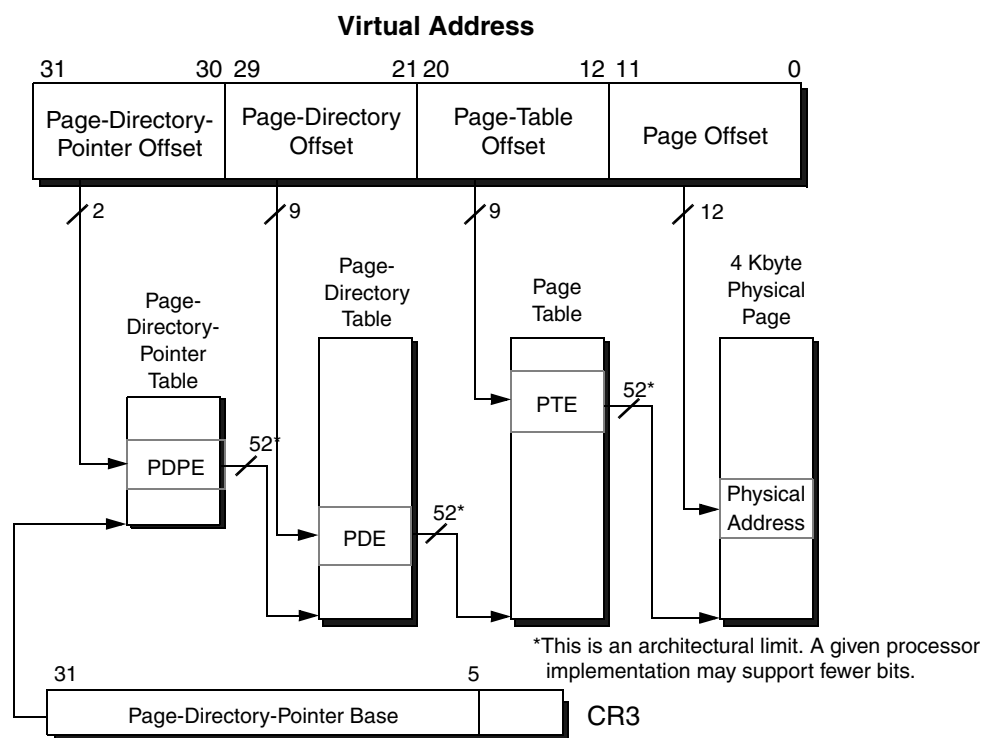

Figure 5-9. 4-Kbyte PAE Page Translation—Legacy Mode

Figures 5-10 through 5-12 show the legacy-mode 4-Kbyte translation-table formats:

- Figure 5-10 shows the PDPE (page-directory-pointer entry) format.
- Figure 5-11 shows the PDE (page-directory entry) format.
- Figure 5-12 shows the PTE (page-table entry) format.

The fields within these table entries are described in “Page-Translation-Table Entry Fields” on page 135.

Figure 5-11 shows the PDE.PS bit cleared to 0 (bit 7), specifying a 4-Kbyte physical-page translation.

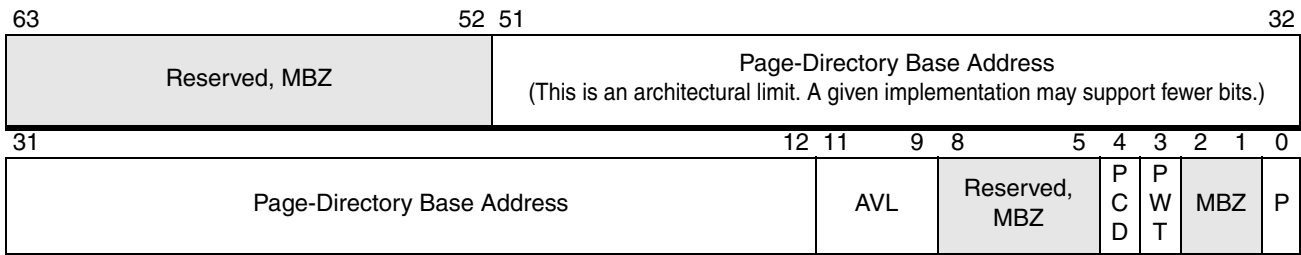

Figure 5-10. 4-Kbyte PDPE—PAE Paging Legacy-Mode

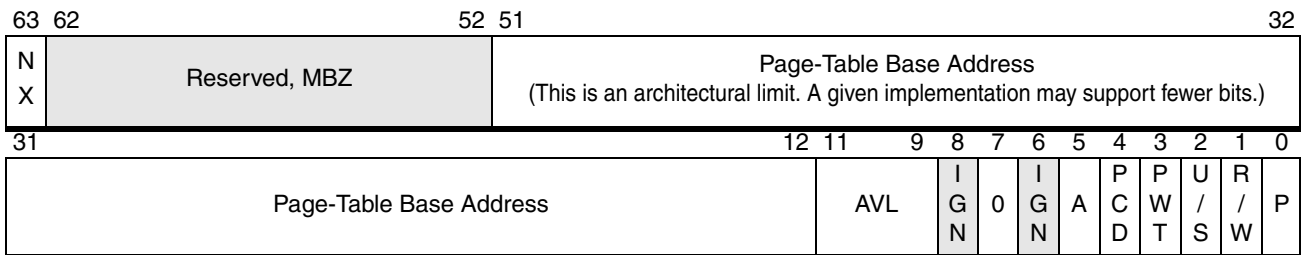

Figure 5-11. 4-Kbyte PDE—PAE Paging Legacy-Mode

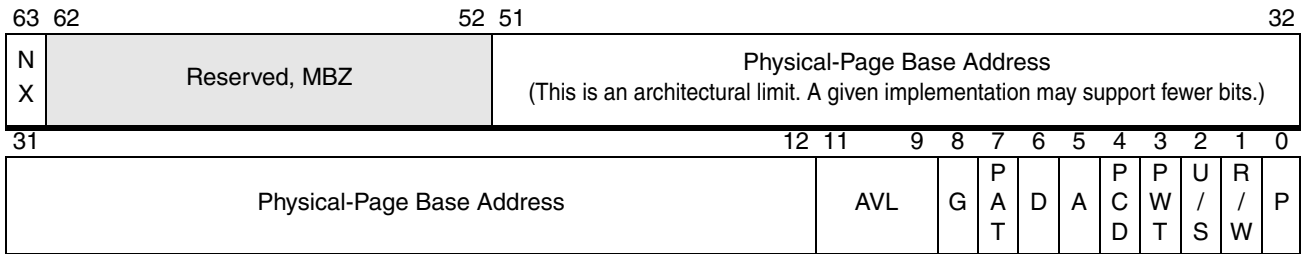

Figure 5-12. 4-Kbyte PTE—PAE Paging Legacy-Mode

2-Mbyte Page Translation. 2-Mbyte page translation is performed by dividing the 32-bit virtual address into three fields. Each field is used as an index into a 2-level page-translation hierarchy. The virtual-address fields are described as follows and are shown in Figure 5-13 on page 127:

- Bits 31–30 index into the 4-entry page-directory-pointer table.
- Bits 29–21 index into the 512-entry page-directory table.
- Bits 20–0 provide the byte offset into the physical page.

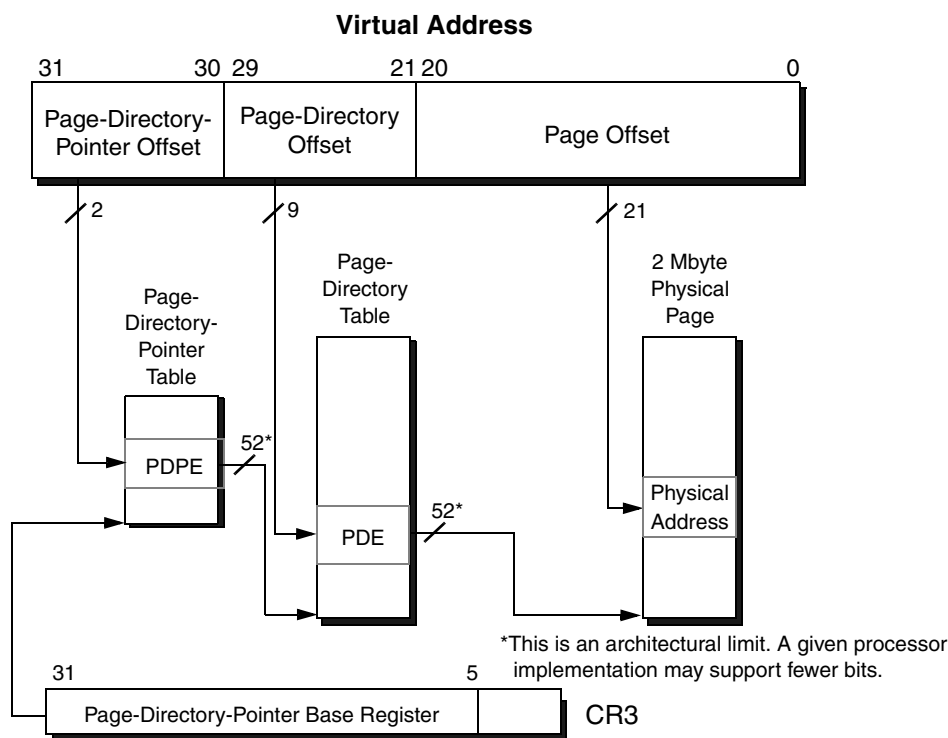

Figure 5-13. 2-Mbyte PAE Page Translation—Legacy Mode

Figure 5-14 shows the format of the PDPE (page-directory-pointer entry) and Figure 5-15 on page 128 shows the format of the PDE (page-directory entry). PTEs are not used in 2-Mbyte page translations.

Figure 5-15 on page 128 shows the PDE.PS bit set to 1 (bit 7), specifying a 2-Mbyte physical-page translation.

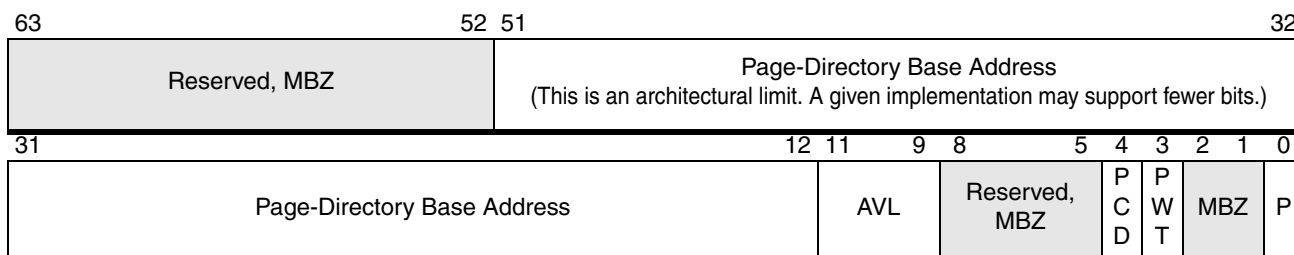

Figure 5-14. 2-Mbyte PDPE—PAE Paging Legacy-Mode

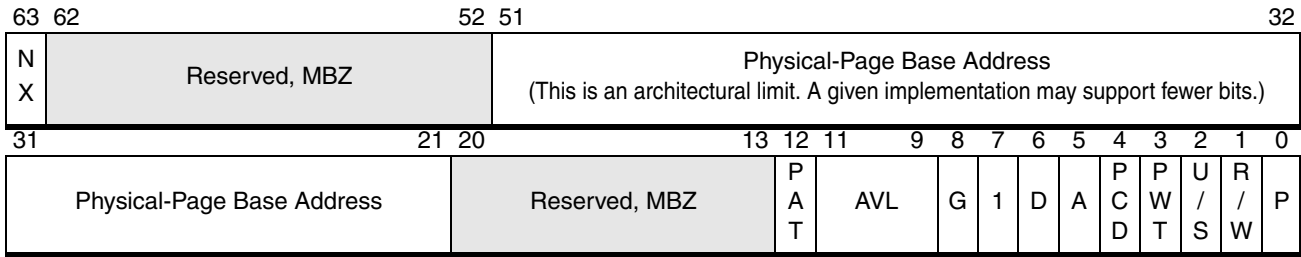

Figure 5-15. 2-Mbyte PDE—PAE Paging Legacy-Mode

5.3 Long-Mode Page Translation

Long-mode page translation requires the use of physical-address extensions (PAE). Before activating long mode, PAE must be enabled by setting CR4.PAE to 1. Activating long mode before enabling PAE causes a general-protection exception (#GP) to occur.

The PAE-paging data structures support mapping of 64-bit virtual addresses into 52-bit physical addresses. PAE expands the size of legacy page-directory entries (PDEs) and page-table entries (PTEs) from 32 bits to 64 bits, allowing physical-address sizes of greater than 32 bits.

The AMD64 architecture enhances the page-directory-pointer entry (PDPE) by defining previously reserved bits for access and protection control. A new translation table is added to PAE paging, called the page-map level-4 (PML4). The PML4 table precedes the PDP table in the page-translation hierarchy.

Because PAE is always enabled in long mode, the PS bit in the page directory entry (PDE.PS) selects between 4-Kbyte and 2-Mbyte page sizes, and the CR4.PSE bit is ignored. When 1-Gbyte pages are supported, the PDPE. PS bit selects the 1-Gbyte page size.

5.3.1 Canonical Address Form

The AMD64 architecture requires implementations supporting fewer than the full 64-bit virtual address to ensure that those addresses are in canonical form. An address is in canonical form if the address bits from the most-significant implemented bit up to bit 63 are all ones or all zeros. If the addresses of all bytes in a virtual-memory reference are not in canonical form, the processor generates a general-protection exception (#GP) or a stack fault (#SS) as appropriate.

5.3.2 CR3

In long mode, the CR3 register is used to point to the PML4 base address. CR3 is expanded to 64 bits in long mode, allowing the PML4 table to be located anywhere in the 52-bit physical-address space. Figure 5-16 on page 129 shows the long-mode CR3 format.

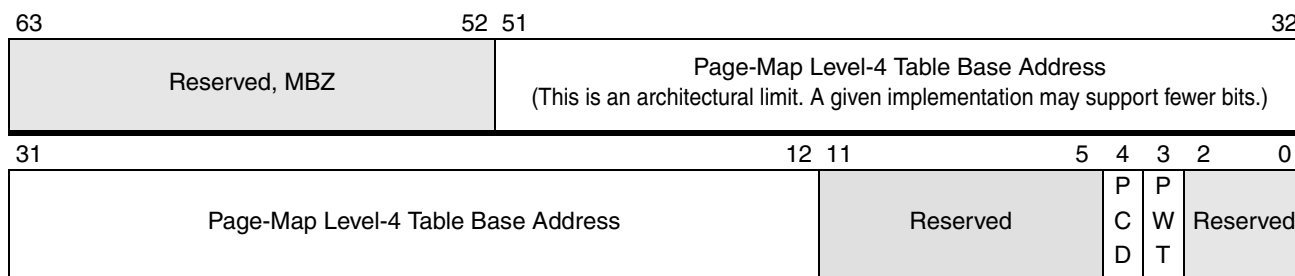

Figure 5-16. Control Register 3 (CR3)—Long Mode

The CR3 register fields for long mode are:

Table Base Address Field. Bits 51–12. This 40-bit field points to the PML4 base address. The PML4 table is aligned on a 4-Kbyte boundary with the low-order 12 address bits (11–0) assumed to be 0. This yields a total base-address size of 52 bits. System software running on processor implementations supporting less than the full 52-bit physical-address space must clear the unimplemented upper base-address bits to 0.

Page-Level Writethrough (PWT) Bit. Bit 3. Page-level writethrough indicates whether the highest-level page-translation table has a writeback or writethrough caching policy. When PWT=0, the table has a writeback caching policy. When PWT=1, the table has a writethrough caching policy.

Page-Level Cache Disable (PCD) Bit. Bit 4. Page-level cache disable indicates whether the highest-level page-translation table is cacheable. When PCD=0, the table is cacheable. When PCD=1, the table is not cacheable.

Reserved Bits. Reserved fields should be cleared to 0 by software when writing CR3.

5.3.3 4-Kbyte Page Translation

In long mode, 4-Kbyte physical-page translation is performed by dividing the virtual address into six fields. Four of the fields are used as indices into the level page-translation hierarchy. The virtual-address fields are described as follows, and are shown in Figure 5-17 on page 130:

- Bits 63–48 are a sign extension of bit 47, as required for canonical-address forms.
- Bits 47–39 index into the 512-entry page-map level-4 table.
- Bits 38–30 index into the 512-entry page-directory pointer table.
- Bits 29–21 index into the 512-entry page-directory table.
- Bits 20–12 index into the 512-entry page table.
- Bits 11–0 provide the byte offset into the physical page.

Note: The sizes of the sign extension and the PML4 fields depend on the number of virtual address bits supported by the implementation.

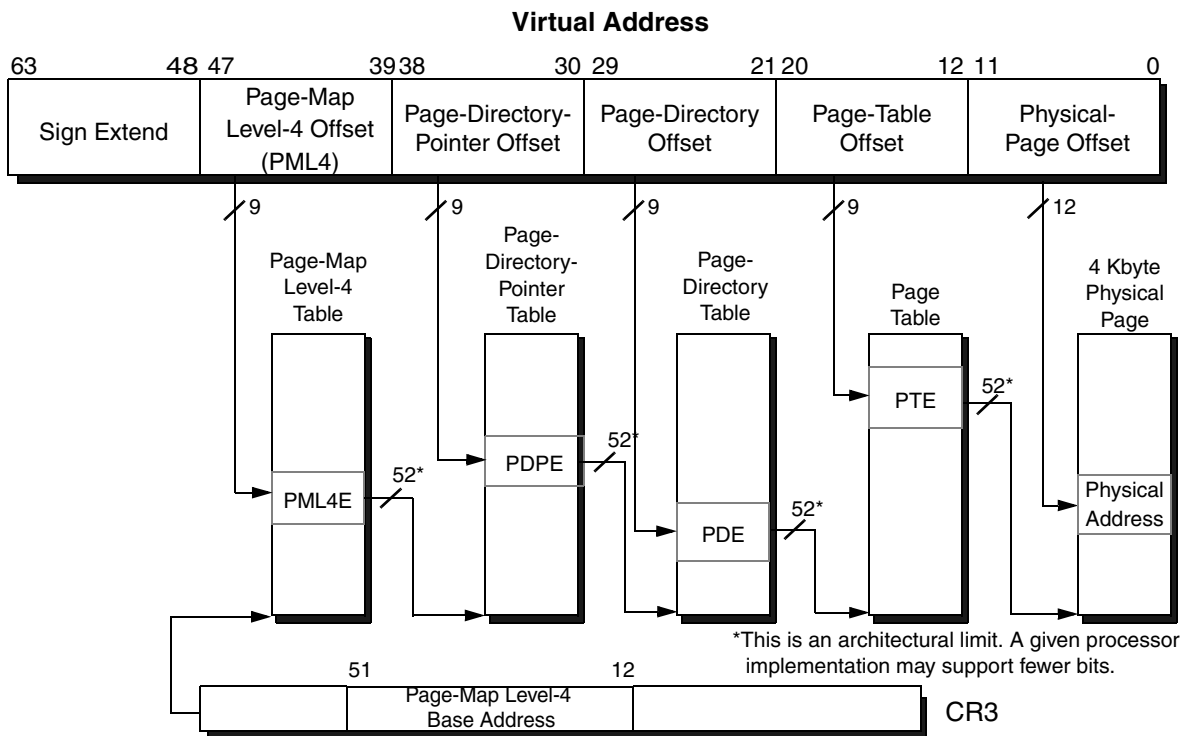

Figure 5-17. 4-Kbyte Page Translation—Long Mode

Figures 5-18 through 5-20 on page 131 and Figure 5-21 on page 131 show the long-mode 4-Kbyte translation-table formats:

- Figure 5-18 on page 131 shows the PML4E (page-map level-4 entry) format.
- Figure 5-19 on page 131 shows the PDPE (page-directory-pointer entry) format.
- Figure 5-20 on page 131 shows the PDE (page-directory entry) format.
- Figure 5-21 on page 131 shows the PTE (page-table entry) format.

The fields within these table entries are described in “Page-Translation-Table Entry Fields” on page 135.

Figure 5-20 on page 131 shows the PDE.PS bit (bit 7) cleared to 0, indicating a 4-Kbyte physical-page translation.

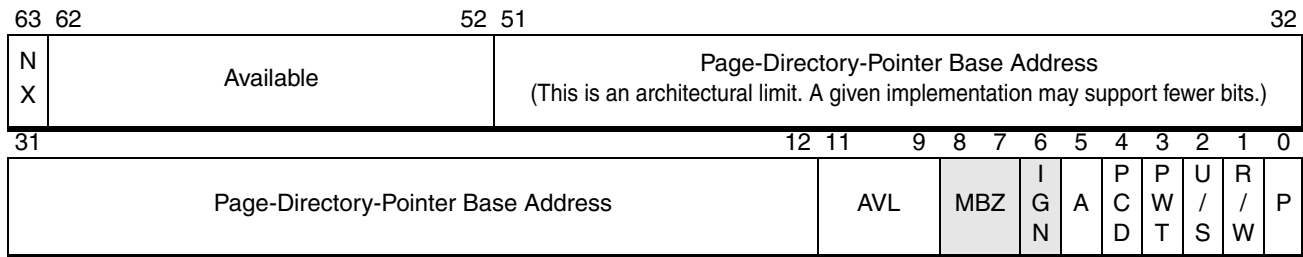

Figure 5-18. 4-Kbyte PML4E—Long Mode

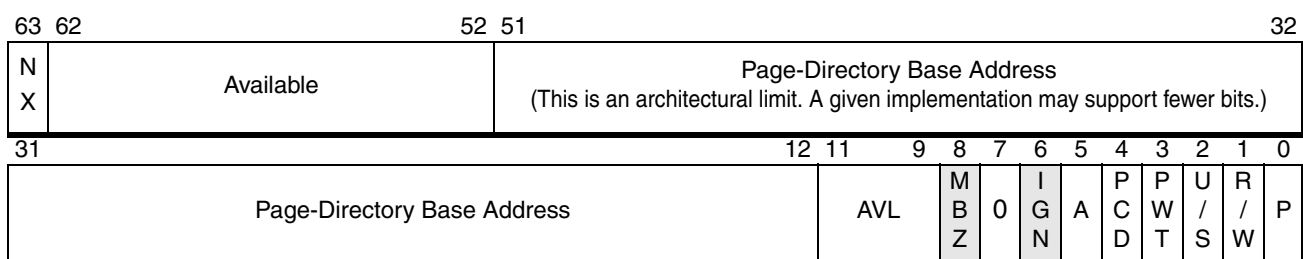

Figure 5-19. 4-Kbyte PDPE—Long Mode

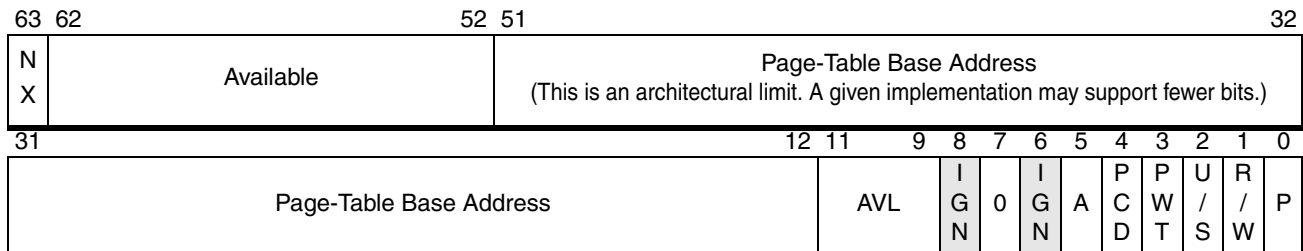

Figure 5-20. 4-Kbyte PDE—Long Mode

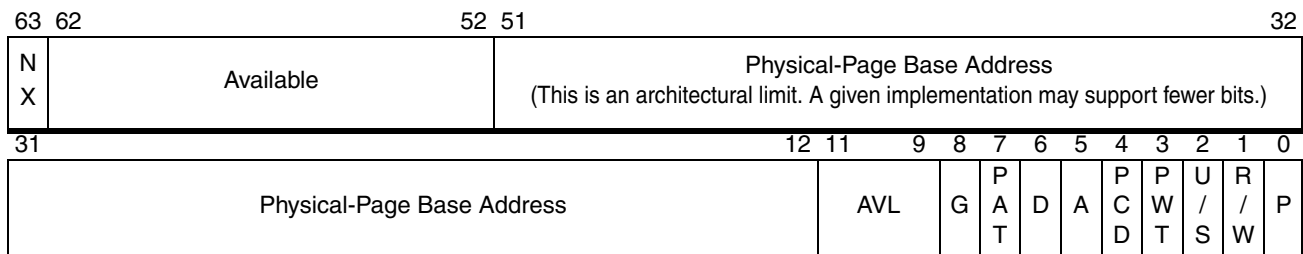

Figure 5-21. 4-Kbyte PTE—Long Mode

5.3.4 2-Mbyte Page Translation

In long mode, 2-Mbyte physical-page translation is performed by dividing the virtual address into five fields. Three of the fields are used as indices into the level page-translation hierarchy. The virtual-address fields are described as follows, and are shown in Figure 5-22:

- Bits 63–48 are a sign extension of bit 47 as required for canonical address forms.
- Bits 47–39 index into the 512-entry page-map level-4 table.
- Bits 38–30 index into the 512-entry page-directory-pointer table.
- Bits 29–21 index into the 512-entry page-directory table.
- Bits 20–0 provide the byte offset into the physical page.

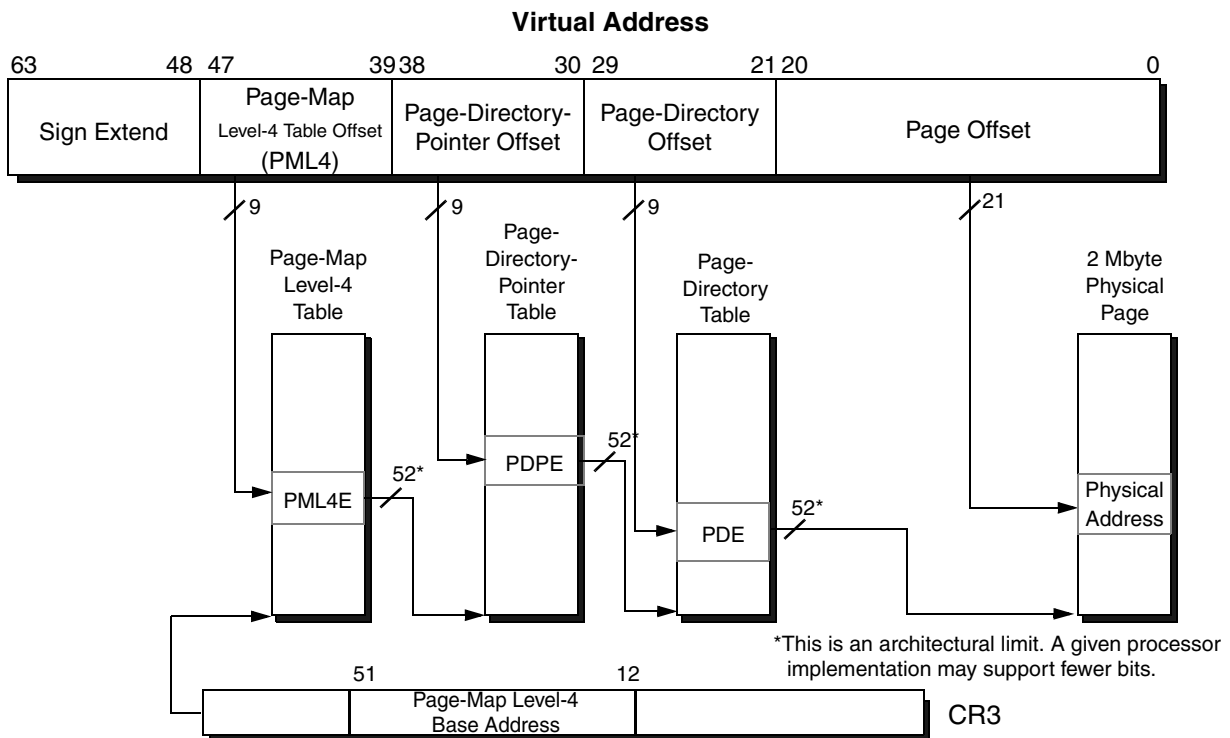

Figure 5-22. 2-Mbyte Page Translation—Long Mode

Figures 5-23 through 5-25 on page 133 show the long-mode 2-Mbyte translation-table formats (the PML4 and PDPT formats are identical to those used for 4-Kbyte page translations and are repeated here for clarity):

- Figure 5-23 on page 133 shows the PML4E (page-map level-4 entry) format.
- Figure 5-24 on page 133 shows the PDPE (page-directory-pointer entry) format.
- Figure 5-25 on page 133 shows the PDE (page-directory entry) format.

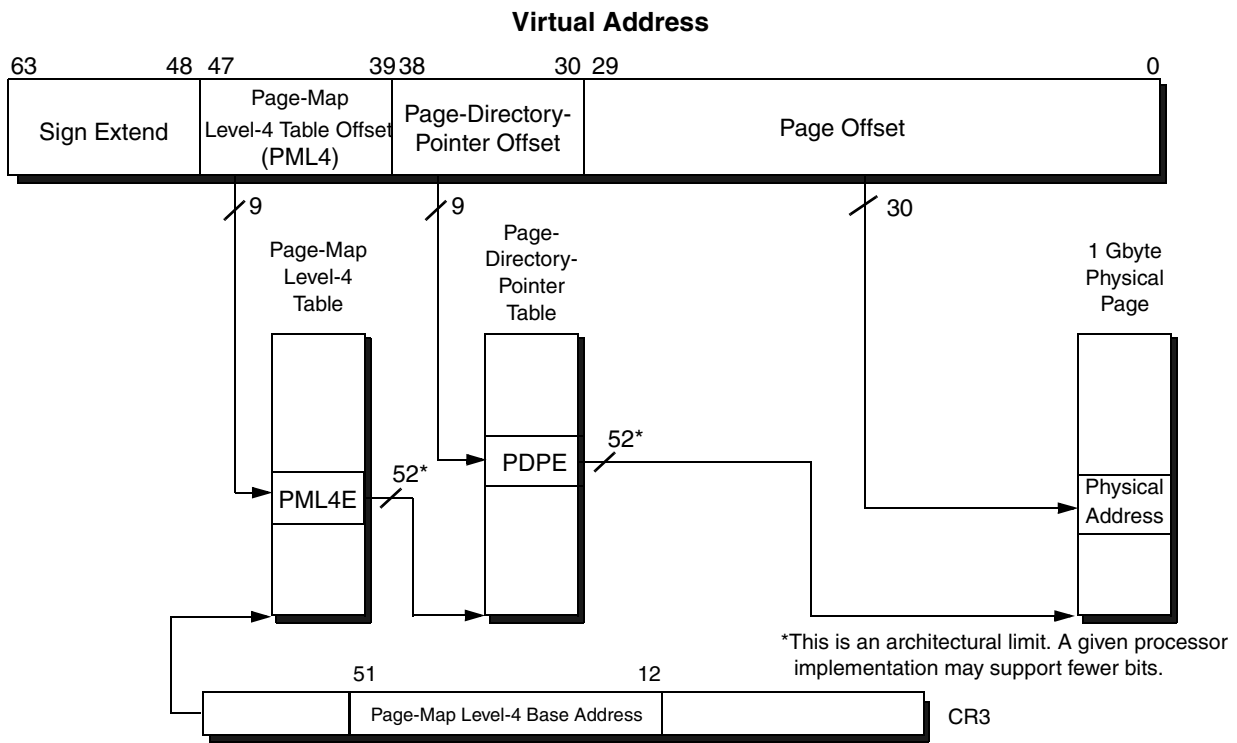

Figure 5-26. 1-Gbyte Page Translation—Long Mode

Figure 5-27 and Figure 5-28 on page 135 show the long mode 1-Gbyte translation-table formats (the PML4 format is identical to the one used for 4-Kbyte page translations and is repeated here for clarity):

- Figure 5-27 shows the PML4E (page-map level-4 entry) format.
- Figure 5-28 shows the PDPE (page-directory-pointer entry) format.

The fields within these table entries are described in “Page-Translation-Table Entry Fields” on page 135 in the current volume. PTEs and PDEs are not used in 1-Gbyte page translations.

Figure 5-28 on page 135 shows the PDPE.PS bit (bit 7) set to 1, indicating a 1-Gbyte physical-page translation.

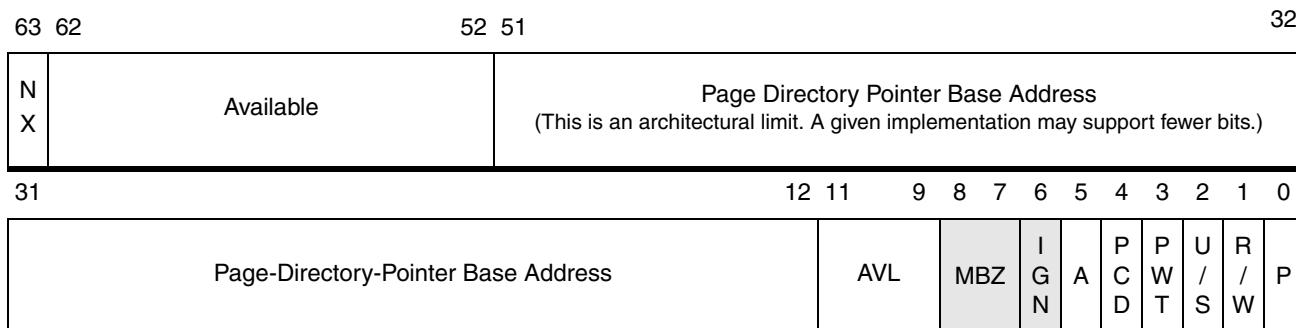

Figure 5-27. 1-Gbyte PML4E—Long Mode

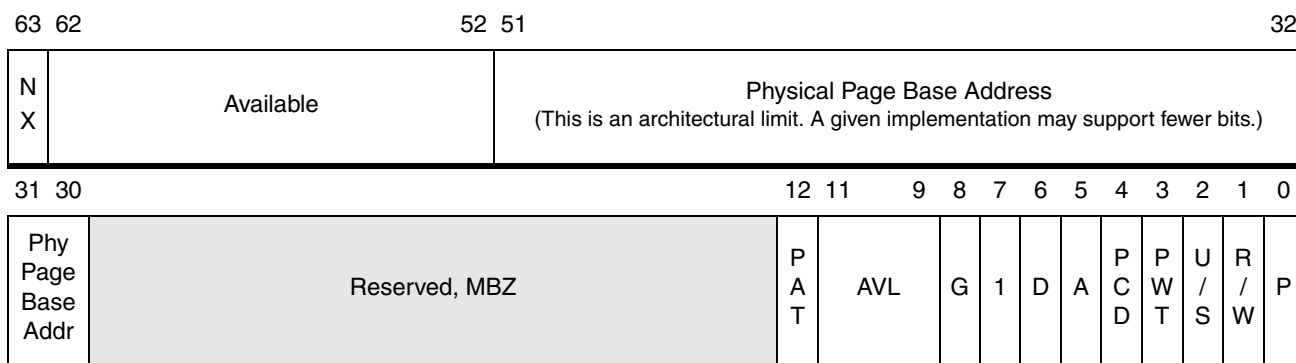

Figure 5-28. 1-Gbyte PDPE—Long Mode

1-Gbyte Paging Feature Identification. EDX bit 26 as returned by CPUID function 8000_0001h indicates 1-Gbyte page support. The EAX register as returned by CPUID function 8000_0019h reports the number of 1-Gbyte L1 TLB entries supported and EBX reports the number of 1-Gbyte L2 TLB entries. See the *CPUID Specification*, order# 25481, for details.

5.4 Page-Translation-Table Entry Fields

The page-translation-table entries contain control and informational fields used in the management of the virtual-memory environment. Most fields are common across all translation table entries and modes and occupy the same bit locations. However, some fields are located in different bit positions depending on the page translation hierarchical level, and other fields have different sizes depending on which physical-page size, physical-address size, and operating mode are selected. Although these fields can differ in bit position or size, their meaning is consistent across all levels of the page translation hierarchy and in all operating modes.

5.4.1 Field Definitions

The following sections describe each field within the page-translation table entries.

Translation-Table Base Address Field. The translation-table base-address field points to the physical base address of the next-lower-level table in the page-translation hierarchy. Page data-structure tables are always aligned on 4-Kbyte boundaries, so only the address bits above bit 11 are stored in the translation-table base-address field. Bits 11–0 are assumed to be 0. The size of the field depends on the mode:

- In normal (non-PAE) paging (CR4.PAE=0), this field specifies a 32-bit physical address.
- In PAE paging (CR4.PAE=1), this field specifies a 52-bit physical address.

52 bits correspond to the maximum physical-address size allowed by the AMD64 architecture. If a processor implementation supports fewer than the full 52-bit physical address, software must clear the unimplemented high-order translation-table base-address bits to 0. For example, if a processor implementation supports a 40-bit physical-address size, software must clear bits 51–40 when writing a translation-table base-address field in a page data-structure entry.

Physical-Page Base Address Field. The physical-page base-address field points to the base address of the translated physical page. This field is found only in the lowest level of the page-translation hierarchy. The size of the field depends on the mode:

- In normal (non-PAE) paging (CR4.PAE=0), this field specifies a 32-bit base address for a physical page.
- In PAE paging (CR4.PAE=1), this field specifies a 52-bit base address for a physical page.

Physical pages can be 4 Kbytes, 2 Mbytes, 4 Mbytes, or 1-Gbyte and they are always aligned on an address boundary corresponding to the physical-page length. For example, a 2-Mbyte physical page is always aligned on a 2-Mbyte address boundary. Because of this alignment, the low-order address bits are assumed to be 0, as follows:

- 4-Kbyte pages, bits 11–0 are assumed 0.
- 2-Mbyte pages, bits 20–0 are assumed 0.
- 4-Mbyte pages, bits 21–0 are assumed 0.
- 1-Gbyte pages, bits 29–0 are assumed 0.

Present (P) Bit. Bit 0. This bit indicates whether the page-translation table or physical page is loaded in physical memory. When the P bit is cleared to 0, the table or physical page is not loaded in physical memory. When the P bit is set to 1, the table or physical page is loaded in physical memory.

Software clears this bit to 0 to indicate a page table or physical page is not loaded in physical memory. A page-fault exception (#PF) occurs if an attempt is made to access a table or page when the P bit is 0. System software is responsible for loading the missing table or page into memory and setting the P bit to 1.

When the P bit is 0, indicating a not-present page, all remaining bits in the page data-structure entry are available to software.

Entries with P cleared to 0 are never cached in TLB nor will the processor set the Accessed or Dirty bit for the table entry.

Read/Write (R/W) Bit. Bit 1. This bit controls read/write access to all physical pages mapped by the table entry. For example, a page-map level-4 R/W bit controls read/write access to all 128M ($512 \times 512 \times 512$) physical pages it maps through the lower-level translation tables. When the R/W bit is cleared to 0, access is restricted to read-only. When the R/W bit is set to 1, both read and write access is allowed. See “Page-Protection Checks” on page 142 for a description of the paging read/write protection mechanism.

User/Supervisor (U/S) Bit. Bit 2. This bit controls user (CPL 3) access to all physical pages mapped by the table entry. For example, a page-map level-4 U/S bit controls the access allowed to all 128M ($512 \times 512 \times 512$) physical pages it maps through the lower-level translation tables. When the U/S bit is cleared to 0, access is restricted to supervisor level (CPL 0, 1, 2). When the U/S bit is set to 1, both user and supervisor access is allowed. See “Page-Protection Checks” on page 142 for a description of the paging user/supervisor protection mechanism.

Page-Level Writethrough (PWT) Bit. Bit 3. This bit indicates whether the page-translation table or physical page to which this entry points has a writeback or writethrough caching policy. When the PWT bit is cleared to 0, the table or physical page has a writeback caching policy. When the PWT bit is set to 1, the table or physical page has a writethrough caching policy. See “Memory Caches” on page 176 for additional information on caching.

Page-Level Cache Disable (PCD) Bit. Bit 4. This bit indicates whether the page-translation table or physical page to which this entry points is cacheable. When the PCD bit is cleared to 0, the table or physical page is cacheable. When the PCD bit is set to 1, the table or physical page is not cacheable. See “Memory Caches” on page 176 for additional information on caching.

Accessed (A) Bit. Bit 5. This bit indicates whether the page-translation table or physical page to which this entry points has been accessed. The A bit is set to 1 by the processor the first time the table or physical page is either read from or written to. The A bit is never cleared by the processor. Instead, software must clear this bit to 0 when it needs to track the frequency of table or physical-page accesses.

Dirty (D) Bit. Bit 6. This bit is only present in the lowest level of the page-translation hierarchy. It indicates whether the page-translation table or physical page to which this entry points has been written. The D bit is set to 1 by the processor the first time there is a write to the physical page. The D bit is never cleared by the processor. Instead, software must clear this bit to 0 when it needs to track the frequency of physical-page writes.

Page Size (PS) Bit. Bit 7. This bit is present in page-directory entries and long-mode page-directory-pointer entries. When the PS bit is set in the page-directory-pointer entry (PDPE) or page-directory entry (PDE), that entry is the lowest level of the page-translation hierarchy. When the PS bit is cleared

to 0 in all levels, the lowest level of the page-translation hierarchy is the page-table entry (PTE), and the physical-page size is 4 Kbytes. The physical-page size is determined as follows:

- If `EFER.LMA=1` and `PDPE.PS=1`, the physical-page size is 1 Gbyte.
- If `CR4.PAE=0` and `PDE.PSE=1`, the physical-page size is 4 Mbytes.
- If `CR4.PAE=1` and `PDE.PSE=1`, the physical-page size is 2 Mbytes.

See Table 5-1 on page 118 for a description of the relationship between the PS bit, PAE, physical-page sizes, and page-translation hierarchy.

Global Page (G) Bit. Bit 8. This bit is only present in the lowest level of the page-translation hierarchy. It indicates the physical page is a global page. The TLB entry for a global page (`G=1`) is not invalidated when `CR3` is loaded either explicitly by a `MOV CRn` instruction or implicitly during a task switch. Use of the G bit requires the page-global enable bit in `CR4` to be set to 1 (`CR4.PGE=1`). See “Global Pages” on page 140 for more information on the global-page mechanism.

Available to Software (AVL) Bit. These bits are not interpreted by the processor and are available for use by system software.

Page-Attribute Table (PAT) Bit. This bit is only present in the lowest level of the page-translation hierarchy, as follows:

- If the lowest level is a PTE (`PDE.PS=0`), PAT occupies bit 7.
- If the lowest level is a PDE (`PDE.PS=1`) or PDPE (`PDPE.PS=1`), PAT occupies bit 12.

The PAT bit is the high-order bit of a 3-bit index into the PAT register (Figure 7-10 on page 193). The other two bits involved in forming the index are the PCD and PWT bits. Not all processors support the PAT bit by implementing the PAT registers. See “Page-Attribute Table Mechanism” on page 193 for a description of the PAT mechanism and how it is used.

No Execute (NX) Bit. Bit 63. This bit is present in the translation-table entries defined for PAE paging, with the exception that the legacy-mode PDPE does not contain this bit. This bit is not supported by non-PAE paging.

The NX bit can only be set when the no-execute page-protection feature is enabled by setting `EFER.NXE` to 1 (see “Extended Feature Enable Register (EFER)” on page 54). If `EFER.NXE=0`, the NX bit is treated as reserved. In this case, a page-fault exception (`#PF`) occurs if the NX bit is not cleared to 0.

This bit controls the ability to execute code from all physical pages mapped by the table entry. For example, a page-map level-4 NX bit controls the ability to execute code from all 128M ($512 \times 512 \times 512$) physical pages it maps through the lower-level translation tables. When the NX bit is cleared to 0, code can be executed from the mapped physical pages. When the NX bit is set to 1, code cannot be executed from the mapped physical pages. See “No Execute (NX) Bit” on page 143 for a description of the no-execute page-protection mechanism.

Reserved Bits. Software should clear all reserved bits to 0. If the processor is in long mode, or if page-size and physical-address extensions are enabled in legacy mode, a page-fault exception (#PF) occurs if reserved bits are not cleared to 0.

5.4.2 Notes on Access and Dirty Bits

The processor never sets the Accessed bit or the Dirty bit for a not present page ($P = 0$). The ordering of Accessed and Dirty bit updates with respect to surrounding loads and stores is discussed below.

Accessed (A) bit. The Accessed bit can be set for instructions that are speculatively executed by the processor.

For example, the Accessed bit may be set by instructions in a mispredicted branch path even though those instructions are never retired. Thus, software must not assume that the TLB entry has not been cached in the TLB, just because no instruction that accessed the page was successfully retired. Nevertheless, a table entry is never cached in the TLB without its Accessed bit being set at the same time.

The processor does not order Accessed bit updates with respect to loads done by other instructions.

Dirty (D) bit. The Dirty bit is not updated speculatively. For instructions with multiple writes, the D bit may be set for any writes completed up to the point of a fault. In rare cases, the Dirty bit may be set even if a write was not actually performed, including MASKMOVQ with a mask of zero and certain x87 floating point instructions that cause an exception. Thus software can not assume that the page has actually been written even where PTE.D is set to 1.

If PTE.D is cleared to 0, software can rely on the fact that the page has not been written.

Dirty bit updates are ordered with respect to other loads and stores. However, to ensure compatibility with future processors, a serializing operation should be inserted before reading the D bit.

5.5 Translation-Lookaside Buffer (TLB)

When paging is enabled, every memory access has its virtual address automatically translated into a physical address using the page-translation hierarchy. *Translation-lookaside buffers* (TLBs), also known as *page-translation caches*, nearly eliminate the performance penalty associated with page translation. TLBs are special on-chip caches that hold the most-recently used virtual-to-physical address translations. Each memory reference (instruction and data) is checked by the TLB. If the translation is present in the TLB, it is immediately provided to the processor, thus avoiding external memory references for accessing page tables.

TLBs take advantage of the *principle of locality*. That is, if a memory address is referenced, it is likely that nearby memory addresses will be referenced in the near future. In the context of paging, the proximity of memory addresses required for locality can be broad—it is equal to the page size. Thus, it is possible for a large number of addresses to be translated by a small number of page translations. This high degree of locality means that almost all translations are performed using the on-chip TLBs.

System software is responsible for managing the TLBs when updates are made to the linear-to-physical mapping of addresses. A change to any paging data-structure entry is not automatically reflected in the TLB, and hardware snooping of TLBs during memory-reference cycles is not performed. Software must invalidate the TLB entry of a modified translation-table entry so that the change is reflected in subsequent address translations. TLB invalidation is described in “TLB Management” on page 140. Only privileged software running at CPL=0 can manage the TLBs.

5.5.1 Global Pages

The processor invalidates the TLB whenever CR3 is loaded either explicitly or implicitly. After the TLB is invalidated, subsequent address references can consume many clock cycles until their translations are cached as new entries in the TLB. Invalidation of TLB entries for frequently-used or critical pages can be avoided by specifying the translations for those pages as *global*. TLB entries for global pages are not invalidated as a result of a CR3 load. Global pages are invalidated using the INVLPG instruction.

Global-page extensions are controlled by setting and clearing the PGE bit in CR4 (bit 7). When CR4.PGE is set to 1, global-page extensions are enabled. When CR4.PGE is cleared to 0, global-page extensions are disabled. When CR4.PGE=1, setting the global (G) bit in the translation-table entry marks the page as global.

The INVLPG instruction ignores the G bit and can be used to invalidate individual global-page entries in the TLB. To invalidate all entries, including global-page entries, disable global-page extensions (CR4.PGE=0).

5.5.2 TLB Management

Generally, unless system software modifies the linear-to-physical address mapping, the processor manages the TLB transparently to software. This includes allocating entries and replacing old entries with new entries. Software changes made to paging-data structures are not automatically reflected in the TLB. In these situations, it is necessary for software to invalidate TLB entries so that these changes are immediately propagated to the page-translation mechanism.

TLB entries can be explicitly invalidated using operations intended for that purpose or implicitly invalidated as a result of another operation. TLB invalidation has no effect on the associated page-translation tables in memory.

Explicit Invalidations. Three mechanisms are provided to explicitly invalidate the TLB:

- The *invalidate TLB entry* instruction (INVLPG) can be used to invalidate specific entries within the TLB. This instruction invalidates a page, regardless of whether it is marked as global or not. The Invalidate TLB entry in a Specified ASID (INVLPGA) operates similarly, but operates on the specified ASID. See “Invalidate Page, Alternate ASID” on page 390.
- Updates to the CR3 register cause the entire TLB to be invalidated *except* for global pages. The CR3 register can be updated with the MOV CR3 instruction. CR3 is also updated during a task switch, with the updated CR3 value read from the TSS of the new task.

- The TLB_CONTROL field of a VMCB can request specific flushes of the TLB to occur when the VMRUN instruction is executed on that VMCB. See “TLB Flush” on page 390.

Implicit Invalidations. The following operations cause the entire TLB to be invalidated, including global pages:

- Modifying the CR0.PG bit (paging enable).
- Modifying the CR4.PAE bit (physical-address extensions), the CR4.PSE bit (page-size extensions), or the CR4.PGE bit (page-global enable).
- Entering SMM as a result of an SMI interrupt.
- Executing the RSM instruction to return from SMM.
- Updating a memory-type range register (MTRR) with the WRMSR instruction.
- External initialization of the processor.
- External masking of the A20 address bit (asserting the A20M# input signal).
- Writes to certain model-specific registers with the WRMSR instruction; see the BIOS and Kernel Developer's Guide for the processor implementation for more information

Speculative Caching of Address Translations. For performance reasons, AMD64 processors may speculatively load valid address translations into the TLB on false execution paths. Such translations are not based on references that a program makes from an “architectural state” perspective, but which the processor may make in speculatively following an instruction path which turns out to be mispredicted. This may occur for both instruction fetches and data references. Such entries remain cached in the TLBs and may be used in subsequent translations. Loading a translation speculatively does not set the A bit.

Caching of Upper Level Translation Table Entries. Similarly, to improve the performance of table walks on TLB misses, AMD64 processors may save upper level translation table entries in special table walk caching structures which are kept coherent with the tables in memory via the same mechanisms as the TLBs—by means of the INVLPG instruction, moves to CR3, and modification of paging control bits in CR0 and CR4. Like address translations in the TLB, these upper level entries may also be cached speculatively and by false-path execution. These entries are never cached if their P (present) bits are set to 0.

Under certain circumstances, an upper-level table entry that cannot ultimately lead to a valid translation (because there are no valid entries in the lower level table to which it points) may also be cached. This can happen while executing down a false path, when an in-progress table walk gets cancelled by the branch mispredict before the low level table entry that would cause a fault is encountered. Said another way, the fact that a page table has no valid entries does not guarantee that upper level table entries won't be accessed and cached in the processor, as long as those upper level entries are marked as present. For this reason, it is not safe to modify an upper level entry, even if no valid lower-level entries exist, without first clearing its present bit, followed by an INVLPG instruction.

Use of Cached Entries When Reporting a Page Fault Exception. On current AMD64 processors, when any type of page fault exception is encountered by the MMU, any cached upper-level entries that lead to the faulting entry are flushed (along with the TLB entry, if already cached) and the table walk is repeated to confirm the page fault using the table entries in memory. This is done because a table entry is allowed to be upgraded (by marking it as present, or by removing its write, execute or supervisor restrictions) without explicitly maintaining TLB coherency. Such an upgrade will be found when the table is re-walked, which resolves the fault. If the fault is confirmed on the re-walk however, a page fault exception is reported, and upper level entries that may have been cached on the re-walk are flushed.

Handling of D-Bit Updates. When the processor needs to set the D bit in the PTE for a TLB entry that is already marked as writable at all cached TLB levels, the table walk that is performed to access the PTE in memory uses cached upper level table entries. This differs from the fault situation previously described, in which cached entries aren't used to confirm the fault during the table walk.

Invalidation of Cached Upper-level Entries by INVLPG. Current AMD64 processors invalidate all cached upper-level entries (in addition to the targeted TLB entry) on any INVLPG instruction. Future implementations may however invalidate only those upper-level entries that are on the table walk path of the address targeted by the INVLPG. Because existing memory management software may rely on the current behavior, a more selective approach that may be implemented in the future will be implemented as a software-visible feature that must be explicitly enabled.

Handling of PDPT Entries in PAE Mode. When 32-bit PAE mode is enabled on AMD64 processors (CR4.PAE is set to 1) a third level of the address translation table hierarchy, the page directory pointer table (PDPT), is enabled. This table contains four entries. On current AMD64 processors, in native mode, these four entries are unconditionally loaded into the table walk cache whenever CR3 is written with the PDPT base address, and remain locked in. At this point they are also checked for reserved bit violations, and if such violations are present a general protection fault occurs.

Under SVM, however, when the processor is in guest mode with PAE enabled, the guest PDPT entries are not cached or validated at this point, but instead are loaded and checked on demand in the normal course of address translation, just like page directory and page table entries. Any reserved bit violations are detected at the point of use, and result in a page fault (#PF) exception rather than a general protection (#GP) fault. The cached PDPT entries are subject to displacement from the table walk cache and reloading from the PDPT, hence software must assume that the PDPT entries may be read by the processor at any point while those tables are active. Future AMD processors may implement this same behavior in native mode as well, rather than pre-loading the PDPT entries.

5.6 Page-Protection Checks

Two forms of page-level memory protection are provided by the legacy architecture. The first form of protection prevents non-privileged (user) code and data from accessing privileged (supervisor) code and data. The second form of protection prevents writes into read-only address spaces. The AMD64 architecture introduces a third form of protection that prevents software from attempting to execute

data pages as instructions. All of these forms of protection are available at all levels of the page-translation hierarchy.

The processor checks a page for execute permission only when the page translation is loaded into the instruction TLB as a result of a page-table walk. The remaining protection checks are performed when a virtual address is translated into a physical address. For those checks, the processor examines the page-level memory-protection bits in the translation tables to determine if the access is allowed. The bits involved in these checks are:

- *User/Supervisor (U/S)*—The U/S bit is introduced in “User/Supervisor (U/S) Bit” on page 137.
- *Read/Write (R/W)*—The R/W bit is introduced in “Read/Write (R/W) Bit” on page 137.
- *Write-Protect Enable (CR0.WP)*—The CR0.WP bit is introduced in “Write Protect (WP) Bit” on page 44.

5.6.1 No Execute (NX) Bit

The NX bit in the page-translation tables specifies whether instructions can be executed from the page. This bit is not checked during every instruction fetch. Instead, the NX bits in the page-translation-table entries are checked by the processor when the instruction TLB is loaded with a page translation. The processor attempts to load the translation into the instruction TLB when an instruction fetch misses the TLB. If a set NX bit is detected (indicating the page is not executable), a page-fault exception (#PF) occurs.

The no-execute protection check applies to all privilege levels. It does not distinguish between supervisor and user-level accesses.

The no-execute protection feature is supported only in PAE-paging mode. It is enabled by setting the NXE bit in the EFER register to 1 (see “Extended Feature Enable Register (EFER)” on page 54). Before setting this bit, system software must verify the processor supports the NX feature by checking the CPUID extended-feature flags (see the *CPUID Specification*, order# 25481).

5.6.2 User/Supervisor (U/S) Bit

The U/S bit in the page-translation tables determines the privilege level required to access the page. Conceptually, user (non-privileged) pages correspond to a current privilege-level (CPL) of 3, or least-privileged. Supervisor (privileged) pages correspond to a CPL of 0, 1, or 2, all of which are jointly regarded as most-privileged.

When the processor is running at a CPL of 0, 1, or 2, it can access both user and supervisor pages. However, when the processor is running at a CPL of 3, it can only access user pages. If an attempt is made to access a supervisor page while the processor is running at CPL=3, a page-fault exception (#PF) occurs.

See “Segment-Protection Overview” on page 93 for more information on the protection-ring concept and CPL.

5.6.3 Read/Write (R/W) Bit

The R/W bit in the page-translation tables specifies the access type allowed for the page. If R/W=1, the page is read/write. If R/W=0, the page is read-only. A page-fault exception (#PF) occurs if an attempt is made by user software to write to a read-only page. If supervisor software attempts to write a read-only page, the outcome depends on the value of the CR0.WP bit (described below).

5.6.4 Write Protect (CR0.WP) Bit

The ability to write to read-only pages is governed by the processor mode and whether write protection is enabled. If write protection is *not* enabled, a processor running at CPL 0, 1, or 2 can write to any physical page, even if it is marked as read-only. Enabling write protection prevents supervisor code from writing into read-only pages, including read-only user-level pages.

A page-fault exception (#PF) occurs if software attempts to write (at any privilege level) into a read-only page while write protection is enabled.

5.7 Protection Across Paging Hierarchy

The privilege level and access type specified at each level of the page-translation hierarchy have a combined effect on the protection of the translated physical page. Enabling and disabling write protection further qualifies the protection effect on the physical page.

Table 5-2 shows the overall effect that privilege level and access type have on physical-page protection when write protection is disabled (CR0.WP=0). In this case, when *any* translation-table entry is specified as supervisor level, the physical page is a supervisor page and can only be accessed by software running at CPL 0, 1, or 2. Such a page allows read/write access even if all levels of the page-translation hierarchy specify read-only access.

Table 5-2. Physical-Page Protection, CR0.WP=0

Page-Map Level-4 Entry		Page-Directory-Pointer Entry		Page-Directory Entry		Page-Table Entry		Effective Result on Physical Page	
U/S	R/W	U/S	R/W	U/S	R/W	U/S	R/W	U/S	R/W
S	—	—	—	—	—	—	—	S	R/W
—	—	S	—	—	—	—	—		
—	—	—	—	S	—	—	—		
—	—	—	—	—	—	S	—		
Note: S = Supervisor Level (CPL=0, 1, or 2), U = User Level (CPL = 3), R = Read-Only Access, R/W = Read/Write Access, — = Don't Care.									
Note: 1. Supervisor-level programs can access these pages as R/W.									

Table 5-2. Physical-Page Protection, CR0.WP=0 (continued)

Page-Map Level-4 Entry		Page-Directory-Pointer Entry		Page-Directory Entry		Page-Table Entry		Effective Result on Physical Page	
U/S	R/W	U/S	R/W	U/S	R/W	U/S	R/W	U/S	R/W
U	R	U	—	U	—	U	—	U	R ¹
U	—	U	R	U	—	U	—		
U	—	U	—	U	R	U	—		
U	—	U	—	U	—	U	R		
U	R/W	U	R/W	U	R/W	U	R/W	U	R/W

Note:
S = Supervisor Level (CPL=0, 1, or 2), U = User Level (CPL = 3), R = Read-Only Access, R/W = Read/Write Access, — = Don't Care.

Note:
 1. *Supervisor-level programs can access these pages as R/W.*

If *all* table entries in the translation hierarchy are specified as user level the physical page is a user page, and both supervisor and user software can access it. In this case the physical page is read-only if any table entry in the translation hierarchy specifies read-only access. All table entries in the translation hierarchy must specify read/write access for the physical page to be read/write.

Table 5-3 shows the overall effect that privilege level and access type have on physical-page access when write protection is enabled (CR0.WP=1). When any translation-table entry is specified as supervisor level, the physical page is a supervisor page and can only be accessed by supervisor software. In this case, the physical page is read-only if any table entry in the translation hierarchy specifies read-only access. All table entries in the translation hierarchy must specify read/write access for the supervisor page to be read/write.

Table 5-3. Effect of CR0.WP=1 on Supervisor Page Access

Page-Map Level-4 Entry	Page Directory-Pointer Entry	Page Directory Entry	Page Table Entry	Physical Page
R/W	R/W	R/W	R/W	R/W
R	—	—	—	R
—	R	—	—	
—	—	R	—	
—	—	—	R	
W	W	W	W	W

Note:
R = Read-Only Access Type, W = Read/Write Access Type, — = Don't Care.
Physical page is in supervisor mode, as determined by U/S settings in Table 5-2.

5.7.1 Access to User Pages when CR0.WP=1

As shown in Table 5-2 on page 144, read/write access to user-level pages behaves the same as when write protection is disabled (CR0.WP=0), with one critical difference. When write protection is enabled, supervisor programs cannot write into read-only user pages.

5.8 Effects of Segment Protection

Segment-protection and page-protection checks are performed serially by the processor, with segment-privilege checks performed first, followed by page-protection checks. Page-protection checks are not performed if a segment-protection violation is found. If a violation is found during either segment-protection or page-protection checking, an exception occurs and no memory access is performed. Segment-protection violations cause either a general-protection exception (#GP) or a stack exception (#SS) to occur. Page-protection violations cause a page-fault exception (#PF) to occur.

6 System-Management Instructions

System-management instructions provide control over the resources used to manage the processor operating environment. This includes memory management, memory protection, task management, interrupt and exception handling, system-management mode, software debug and performance analysis, and model-specific features. Most instructions used to access these resources are privileged and can only be executed while the processor is running at CPL=0, although some instructions can be executed at any privilege level.

Table 6-1 summarizes the instructions used for system management. These include all privileged instructions, instructions whose privilege requirement is under the control of system software, non-privileged instructions that are used primarily by system software, and instructions used to transfer control to system software. Most of the instructions listed in Table 6-1 are summarized in this chapter, although a few are introduced elsewhere in this manual, as indicated in the *Reference* column of Table 6-1.

For details on individual system instructions, see “System Instruction Reference” in Volume 3.

Table 6-1. System Management Instructions

Mnemonic	Name	Privilege			Reference
		CPL=0	O/S ¹	Any	
ARPL	Adjust Requestor Privilege Level			X	“Adjusting Access Rights” on page 156
CLI	Clear Interrupt Flag		X		“CLI and STI Instructions” on page 154
CLTS	Clear Task-Switched Flag in CR0	X			“CLTS Instruction” on page 153
HLT	Halt	X			“Processor Halt” on page 156
INT3	Interrupt to Debug Vector			X	“Breakpoint Instruction (INT3)” on page 340
INVD	Invalidate Caches	X			“Cache Management” on page 157
INVLPG	Invalidate TLB Entry	X			“TLB Invalidation” on page 157
IRET _x	Interrupt Return (all forms)			X	“Returning From Interrupt Procedures” on page 238
LAR	Load Access-Rights Byte			X	“Checking Access Rights” on page 156
LGDT	Load Global-Descriptor-Table Register	X			“LGDT and LIDT Instructions” on page 155
LIDT	Load Interrupt-Descriptor-Table Register	X			
Note:					
1. The operating system controls the privilege required to use the instruction.					

Table 6-1. System Management Instructions (continued)

Mnemonic	Name	Privilege			Reference
		CPL=0	O/S ¹	Any	
LLDT	Load Local-Descriptor-Table Register	X			“LLDT and LTR Instructions” on page 155
LMSW	Load Machine-Status Word	X			“LMSW and SMSW Instructions” on page 153
LSL	Load Segment Limit			X	“Checking Segment Limits” on page 156
LTR	Load Task Register	X			“LLDT and LTR Instructions” on page 155
MOV CR _n	Move to/from Control Registers	X			“MOV CR _n Instructions” on page 153
MOV DR _n	Move to/from Debug Registers	X			“Accessing Debug Registers” on page 154
RDMSR	Read Model-Specific Register	X			“RDMSR and WRMSR Instructions” on page 154
RDPMC	Read Performance-Monitor Counter		X		“RDPMC Instruction” on page 154
RDTS	Read Time-Stamp Counter		X		“RDTS Instruction” on page 154
RDTSR	Read Time-Stamp Counter and Processor ID		X		“RDTSR Instruction” on page 154
RSM	Return from System-Management Mode			X	“Leaving SMM” on page 286
SGDT	Store Global-Descriptor-Table Register			X	“SGDT and SIDT Instructions” on page 155
SIDT	Store Interrupt-Descriptor-Table Register			X	
SLDT	Store Local-Descriptor-Table Register			X	“SLDT and STR Instructions” on page 155
SMSW	Store Machine-Status Word			X	“LMSW and SMSW Instructions” on page 153
STI	Set Interrupt Flag		X		“CLI and STI Instructions” on page 154
STR	Store Task Register			X	“SLDT and STR Instructions” on page 155
SWAPGS	Swap GS and KernelGSbase Registers	X			“SWAPGS Instruction” on page 152
SYSCALL	Fast System Call			X	“SYSCALL and SYSRET” on page 150

Note:
1. The operating system controls the privilege required to use the instruction.

Table 6-1. System Management Instructions (continued)

Mnemonic	Name	Privilege			Reference
		CPL=0	O/S ¹	Any	
SYSENTER	System Call			X	“SYSENTER and SYSEXIT (Legacy Mode Only)” on page 152
SYSEXIT	System Return	X			
SYSRET	Fast System Return	X			“SYSCALL and SYSRET” on page 150
UD2	Undefined Operation			X	“System Instruction Reference” in Volume 3
VERR	Verify Segment for Reads			X	“Checking Read/Write Rights” on page 156
VERW	Verify Segment for Writes			X	
WBINVD	Writeback and Invalidate Caches	X			“Cache Management” on page 157
WRMSR	Write Model-Specific Register	X			“RDMSR and WRMSR Instructions” on page 154
Note:					
1. The operating system controls the privilege required to use the instruction.					

The following instructions are summarized in this chapter but are not categorized as system instructions, because of their importance to application programming:

- The CPUID instruction returns information critical to system software in initializing the operating environment. It is fully described in “Processor Feature Identification” on page 61.
- The PUSHF and POPF instructions set and clear certain RFLAGS bits depending on the processor operating mode and privilege level. These dependencies are described in “POPF and PUSHF Instructions” on page 154.
- The MOV, PUSH, and POP instructions can be used to load and store segment registers, as described in “MOV, POP, and PUSH Instructions” on page 155.

6.1 Fast System Call and Return

Operating systems can use both paging and segmentation to implement protected memory models. Segment descriptors provide the necessary memory protection and privilege checking for segment accesses. By setting segment-descriptor fields appropriately, operating systems can enforce access restrictions as needed.

A disadvantage of segment-based protection and privilege checking is the overhead associated with loading a new segment selector (and its corresponding descriptor) into a segment register. Even when using the flat-memory model, this overhead still occurs when switching between privilege levels because code segments (CS) and stack segments (SS) are reloaded with different segment descriptors.

To initiate a call to the operating system, an application transfers control to the operating system through a gate descriptor (call, interrupt, trap, or task gate). In the past, control was transferred using

either a far CALL instruction or a software interrupt. Transferring control through one of these gates is slowed by the segmentation-related overhead, as is the later return using a far RET or IRET instruction. The following checks are performed when control is transferred in this manner:

- Selectors, gate descriptors, and segment descriptors are in the proper form.
- Descriptors lie within the bounds of the descriptor tables.
- Gate descriptors reference the appropriate segment descriptors.
- The caller, gate, and target privileges all allow the control transfer to take place.
- The stack created by the call has sufficient properties to allow the transfer to take place.

In addition to these call-gate checks, other checks are made involving the task-state segment when a task switch occurs.

6.1.1 SYSCALL and SYSRET

SYSCALL and SYSRET Instructions. SYSCALL and SYSRET are low-latency system call and return instructions. These instructions assume the operating system implements a flat-memory model, which greatly simplifies calls to and returns from the operating system. This simplification comes from eliminating unneeded checks, and by loading pre-determined values into the CS and SS segment registers (both visible and hidden portions). As a result, SYSCALL and SYSRET can take fewer than one-fourth the number of internal clock cycles to complete than the legacy CALL and RET instructions. SYSCALL and SYSRET are particularly well-suited for use in 64-bit mode, which requires implementation of a paged, flat-memory model.

SYSCALL and SYSRET require that the code-segment base, limit, and attributes (except for CPL) are consistent for all application and system processes. Only the CPL is allowed to vary. The processor assumes (but does not check) that the SYSCALL target CS has CPL=0 and the SYSRET target CS has CPL=3.

For details on the SYSCALL and SYSRET instructions, see “System Instruction Reference” in Volume 3.

SYSCALL and SYSRET MSRs. The STAR, LSTAR, and CSTAR registers are model-specific registers (MSRs) used to specify the target address of a SYSCALL instruction as well as the CS and SS selectors of the called and returned procedures. The SFMASK register is used in long mode to specify how rFLAGS is handled by these instructions. Figure 6-1 on page 151 shows the STAR, LSTAR, CSTAR, and SFMASK register formats.

		63	48	47	32	31	0
STAR	C000_0081h	SYSRET CS and SS		SYSCALL CS and SS		32-bit SYSCALL Target EIP	
LSTAR	C000_0082h	Target RIP for 64-Bit-Mode Calling Software					
CSTAR	C000_0083h	Target RIP for Compatibility-Mode Calling Software					
SFMASK	C000_0084h	Reserved, RAZ			SYSCALL Flag Mask		

Figure 6-1. STAR, LSTAR, CSTAR, and MASK MSRs

- **STAR**—The STAR register has the following fields (unless otherwise noted, all bits are read/write):
 - **SYSRET CS and SS Selectors**—**Bits 63–48**. This field is used to specify both the CS and SS selectors loaded into CS and SS during SYSRET. If SYSRET is returning to 32-bit mode (either legacy or compatibility), this field is copied directly into the CS selector field. If SYSRET is returning to 64-bit mode, the CS selector is set to this field + 16. SS.Sel is set to this field + 8, regardless of the target mode. Because SYSRET always returns to CPL 3, the RPL bits 49–48 should be initialized to 11b.
 - **SYSCALL CS and SS Selectors**—**Bits 47–32**. This field is used to specify both the CS and SS selectors loaded into CS and SS during SYSCALL. This field is copied directly into CS.Sel. SS.Sel is set to this field + 8. Because SYSCALL always switches to CPL 0, the RPL bits 33–32 should be initialized to 00b.
 - **32-bit SYSCALL Target EIP**—**Bits 31–0**. This is the target EIP of the called procedure.

The legacy STAR register is not expanded in long mode to provide a 64-bit target RIP address. Instead, long mode provides two new STAR registers—long STAR (LSTAR) and compatibility STAR (CSTAR)—that hold a 64-bit target RIP.
- **LSTAR and CSTAR**—The LSTAR register holds the target RIP of the called procedure in long mode when the calling software is in 64-bit mode. The CSTAR register holds the target RIP of the called procedure in long mode when the calling software is in compatibility mode. The WRMSR instruction is used to load the target RIP into the LSTAR and CSTAR registers. If the RIP written to either of the MSRs is not in canonical form, a #GP fault is generated on the WRMSR instruction.
- **SFMASK**—The SFMASK register is used to specify which RFLAGS bits are cleared during a SYSCALL. In long mode, SFMASK is used to specify which RFLAGS bits are cleared when SYSCALL is executed. If a bit in SFMASK is *set to 1*, the corresponding bit in RFLAGS is *cleared to 0*. If a bit in SFMASK is cleared to 0, the corresponding rFLAGS bit is not modified.

6.1.2 SYSENTER and SYSEXIT (Legacy Mode Only)

SYSENTER and SYSEXIT Instructions. Like SYSCALL and SYSRET, SYSENTER and SYSEXIT are low-latency system call and return instructions designed for use by system and application software implementing a flat-memory model. However, *these instructions are illegal in long mode and result in an undefined opcode exception (#UD) if software attempts to use them.* Software should use the SYSCALL and SYSRET instructions when running in long mode.

SYSENTER and SYSEXIT MSRs. Three model-specific registers (MSRs) are used to specify the target address and stack pointers for the SYSENTER instruction as well as the CS and SS selectors of the called and returned procedures. The register fields are:

- *SYSENTER Target CS*—Holds the CS selector of the called procedure.
- *SYSENTER Target ESP*—Holds the called-procedure stack pointer. The SS selector is updated automatically to point to the next descriptor entry after the SYSENTER Target CS, and ESP is the offset into that stack segment.
- *SYSENTER Target EIP*—Holds the offset into the CS of the called procedure.

Figure 6-2 shows the register formats and their corresponding MSR IDs.

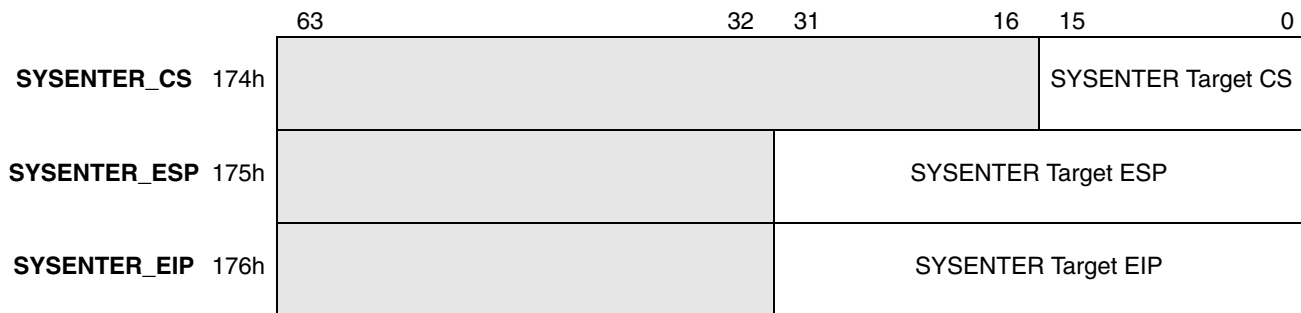

Figure 6-2. SYSENTER_CS, SYSENTER_ESP, SYSENTER_EIP MSRs

6.1.3 SWAPGS Instruction

The SWAPGS instruction provides a fast method for system software to load a pointer to system data structures. SWAPGS can be used upon entering system-software routines as a result of a SYSCALL instruction or as a result of an interrupt or exception. Before returning to application software, SWAPGS can restore an application data-structure pointer that was replaced by the system data-structure pointer.

SWAPGS exchanges the base-address value located in the KernelGSbase model-specific register (MSR address C000_0102h) with the base-address value located in the hidden portion of the GS selector register (GS.base). This exchange allows the system-kernel software to quickly access kernel data structures by using the GS segment-override prefix during memory references.

The need for SwapGS arises from the requirement that, upon entry to the OS kernel, the kernel needs to obtain a 64-bit pointer to its essential data structures. When using SYSCALL to implement system

calls, no kernel stack exists at the OS entry point. Neither is there a straightforward method to obtain a pointer to kernel structures, from which the kernel stack pointer could be read. Thus, the kernel cannot save GPRs or reference memory. SwapGS does not require any GPR or memory operands, so no registers need to be saved before using it. Similarly, when the OS kernel is entered via an interrupt or exception (where the kernel stack is already set up), SwapGS can be used to quickly get a pointer to the kernel data structures.

See “FS and GS Registers in 64-Bit Mode” on page 70 for more information on using the GS.base register in 64-bit mode.

6.2 System Status and Control

System-status and system-control instructions are used to determine the features supported by a processor, gather information about the current execution state, and control the processor operating modes.

6.2.1 Processor Feature Identification (CPUID)

CPUID Instruction. The CPUID instruction provides complete information about the processor implementation and its capabilities. Software operating at any privilege level can execute the CPUID instruction to collect this information. System software normally uses the CPUID instruction to determine which optional features are available so the system can be configured appropriately. The optional features identified by the CPUID instruction are described in “CPUID” in Volume 3.

6.2.2 Accessing Control Registers

MOV CR_n Instructions. The MOV CR_n instructions can be used to copy data between the control registers and the general-purpose registers. These instructions are privileged and cause a general-protection exception (#GP) if non-privileged software attempts to execute them.

LMSW and SMSW Instructions. The machine status word is located in CR0 register bits 15–0. The *load machine status word* (LMSW) instruction writes only the least-significant four status-word bits (CR0[3:0]). All remaining status-word bits (CR0[15:4]) are left unmodified by the instruction. The instruction is privileged and causes a #GP to occur if non-privileged software attempts to execute it.

The *store machine status word* (SMSW) instruction stores all 16 status-word bits (CR0[15:0]) into the target GPR or memory location. The instruction is not privileged and can be executed by all software.

CLTS Instruction. The *clear task-switched bit* instruction (CLTS) clears CR0.TS to 0. The CR0.TS bit is set to 1 by the processor every time a task switch takes place. The bit is useful to system software in determining when the x87 and multimedia register state should be saved or restored. See “Task Switched (TS) Bit” on page 44 for more information on using CR0.TS to manage x87-instruction state. The CLTS instruction is privileged and causes a #GP to occur if non-privileged software attempts to execute it.

6.2.3 Accessing the RFLAGS Register

The RFLAGS register contains both application and system bits. This section describes the instructions used to read and write system bits. Descriptions of instruction effects on application flags can be found in “Flags Register” in Volume 1 and “Instruction Effects on RFLAGS” in Volume 3.

POPF and PUSHF Instructions. The *pop and push RFLAGS* instructions are used for moving data between the rFLAGS register and the stack. They are not system-management instructions, but their behavior is mode-dependent.

CLI and STI Instructions. The *clear interrupt (CLI)* and *set interrupt (STI)* instructions modify only the RFLAGS.IF bit or RFLAGS.VIF bit. Clearing rFLAGS.IF to 0 causes the processor to ignore maskable interrupts. Setting RFLAGS.IF to 1 causes the processor to allow maskable interrupts.

See “Virtual Interrupts” on page 247 for more information on the operation of these instructions when virtual-8086 mode extensions are enabled (CR4.VME=1).

6.2.4 Accessing Debug Registers

The MOV DR n instructions are used to copy data between the debug registers and the general-purpose registers. These instructions are privileged and cause a general-protection exception (#GP) if non-privileged software attempts to execute them. See “Debug Registers” on page 328 for a detailed description of the debug registers.

6.2.5 Accessing Model-Specific Registers

RDMSR and WRMSR Instructions. The *read/write model-specific register* instructions (RDMSR and WRMSR) can be used by privileged software to access the 64-bit MSRs. See “Model-Specific Registers (MSRs)” on page 56 for details about the MSRs.

RDPMC Instruction. The *read performance-monitoring counter* instruction, RDPMC, is used to read the model-specific performance-monitor registers, PerfCTR[3:0].

RDTSC Instruction. The *read time-stamp counter* instruction, RDTSC, is used to read the model-specific time-stamp counter (TSC) register.

RDTSCP Instruction. The *read time-stamp counter and processor ID* instruction, RDTSCP, is used to read the model-specific time-stamp counter (TSC) register, as well as the low 32 bits of the TSC_AUX register (MSR C000_0103h).

6.3 Segment Register and Descriptor Register Access

The AMD64 architecture supports the legacy instructions that load and store segment registers and descriptor registers. In some cases the instruction capabilities are expanded to support long mode.

6.3.1 Accessing Segment Registers

MOV, POP, and PUSH Instructions. The MOV and POP instructions can be used to load a selector into a segment register from a general-purpose register or memory (MOV) or from the stack (POP). Any segment register, except the CS register, can be loaded with the MOV and POP instructions. The CS register must be loaded with a far-transfer instruction.

All segment register selectors can be stored in a general-purpose register or memory using the MOV instruction or pushed onto the stack using the PUSH instruction.

When a selector is loaded into a segment register, the processor automatically loads the corresponding descriptor-table entry into the hidden portion of the selector register. The hidden portion contains the base address, limit, and segment attributes.

Segment-load and segment-store instructions work normally in 64-bit mode. The appropriate entry is read from the system descriptor table (GDT or LDT) and is loaded into the hidden portion of the segment descriptor register. However, the contents of data-segment and stack-segment descriptor registers are ignored, except in the case of the FS and GS segment-register base fields—see “FS and GS Registers in 64-Bit Mode” on page 70 for more information.

The ability to use segment-load instructions allows a 64-bit operating system to set up segment registers for a compatibility-mode application before switching to compatibility mode.

6.3.2 Accessing Descriptor-Table Registers

LGDT and LIDT Instructions. The *load GDTR* (LGDT) and *load IDTR* (LIDT) instructions load a *pseudo-descriptor* from memory into the GDTR or IDTR registers, respectively.

LLDT and LTR Instructions. The *load LDTR* (LLDT) and *load TR* (LTR) instructions load a system-segment descriptor from the GDT into the LDTR and TR segment-descriptor registers (hidden portion), respectively.

SGDT and SIDT Instructions. The *store GDTR* (SGDT) and *store IDTR* (SIDT) instructions reverse the operation of the LGDT and LIDT instructions. SGDT and SIDT store a pseudo-descriptor from the GDTR or IDTR register into memory.

SLDT and STR Instructions. In all modes, the *store LDTR* (SLDT) and *store TR* (STR) instructions store the LDT or task selector from the visible portion of the LDTR or TR register into a general-purpose register or memory, respectively. The hidden portion of the LDTR or TR register is not stored.

6.4 Protection Checking

Several instructions are provided to allow software to determine the outcome of a protection check before performing a memory access that could result in a protection violation. By performing the checks before a memory access, software can avoid violations that result in a general-protection exception (#GP).

6.4.1 Checking Access Rights

LAR Instruction. The *load access-rights* (LAR) instruction can be used to determine if access to a segment is allowed, based on privilege checks and type checks. The LAR instruction uses a segment-selector in the source operand to reference a descriptor in the GDT or LDT. LAR performs a set of access-rights checks and, if successful, loads the segment-descriptor access rights into the destination register. Software can further examine the access-rights bits to determine if access into the segment is allowed.

6.4.2 Checking Segment Limits

LSL Instruction. The *load segment-limit* (LSL) instruction uses a segment-selector in the source operand to reference a descriptor in the GDT or LDT. LSL performs a set of preliminary access-rights checks and, if successful, loads the segment-descriptor limit field into the destination register. Software can use the limit value in comparisons with pointer offsets to prevent segment limit violations.

6.4.3 Checking Read/Write Rights

VERR and VERW Instructions. The *verify read-rights* (VERR) and *verify write-rights* (VERW) can be used to determine if a target code or data segment (not a system segment) can be read or written from the current privilege level (CPL). The source operand for these instructions is a pointer to the segment selector to be tested. If the tested segment (code or data) is readable from the current CPL, the VERR instruction sets RFLAGS.ZF to 1; otherwise, it is cleared to zero. Likewise, if the tested data segment is writable, the VERW instruction sets the RFLAGS.ZF to 1. A code segment cannot be tested for writability.

6.4.4 Adjusting Access Rights

ARPL Instruction. The *adjust RPL-field* (ARPL) instruction can be used by system software to prevent access into privileged-data segments by lower-privileged software. This can happen if an application passes a selector to system software and the selector RPL is less than (has greater privilege than) the calling-application CPL. To prevent this surrogate access, system software executes ARPL with the following operands:

- The destination operand is the data-segment selector passed to system software by the application.
- The source operand is the application code-segment selector (available on the system-software stack as a result of the CALL into system software by the application).

ARPL is not supported in 64-bit mode.

6.5 Processor Halt

The *processor halt* instruction (HLT) halts instruction execution, leaving the processor in the halt state. No registers or machine state are modified as a result of executing the HLT instruction. The processor remains in the halt state until one of the following occurs:

- A non-maskable interrupt (NMI).
- An enabled, maskable interrupt (INTR).
- Processor reset (RESET).
- Processor initialization (INIT).
- System-management interrupt (SMI).

6.6 Cache and TLB Management

Cache-management instructions are used by system software to maintain coherency within the memory hierarchy. Memory coherency and caches are discussed in Chapter 7, “Memory System.” Similarly, TLB-management instructions are used to maintain coherency between page translations cached in the TLB and the translation tables maintained by system software in memory. See “Translation-Lookaside Buffer (TLB)” on page 139 for more information.

6.6.1 Cache Management

WBINVD Instruction. The *writeback and invalidate* (WBINVD) instruction is used to write all modified cache lines to memory so that memory contains the most recent copy of data. After the writes are complete, the instruction invalidates all cache lines. This instruction operates on all caches in the memory hierarchy, including caches that are external to the processor.

INVD Instruction. The *invalidate* (INVD) instruction is used to invalidate all cache lines in all caches in the memory hierarchy. Unlike the WBINVD instruction, no modified cache lines are written to memory. The INVD instruction should only be used in situations where memory coherency is not required.

6.6.2 TLB Invalidation

INVLPG Instruction. The *invalidate TLB entry* (INVLPG) instruction can be used to invalidate specific entries within the TLB. The source operand is a virtual-memory address that specifies the TLB entry to be invalidated. Invalidating a TLB entry does not remove the associated page-table entry from the data cache. See “Translation-Lookaside Buffer (TLB)” on page 139 for more information.

7 Memory System

This chapter describes:

- Cache coherency mechanisms
- Cache control mechanisms
- Memory typing
- Memory mapped I/O
- Memory ordering rules
- Serializing instructions

Figure 7-1 on page 160 shows a conceptual picture of a processor and memory system, and how data and instructions flow between the various components. This diagram is not intended to represent a specific microarchitectural implementation but instead is used to illustrate the major memory-system components covered by this chapter.

- *L1 Data Cache*—The L1 (level-1) data cache holds the data most recently read or written by the software running on the processor.
- *L1 Instruction Cache*—The L1 instruction cache is similar to the L1 data cache except that it holds only the instructions executed most frequently. In some processor implementations, the L1 instruction cache can be combined with the L1 data cache to form a unified L1 cache.
- *L2 Cache*—The L2 (level-2) cache is usually several times larger than the L1 caches, but it is also slower. It is common for L2 caches to be implemented as a unified cache containing both instructions and data. Recently used instructions and data that do not fit within the L1 caches can reside in the L2 cache. The L2 cache can be exclusive, meaning it does not cache information contained in the L1 cache. Conversely, inclusive L2 caches contain a copy of the L1-cached information.

Memory-read operations from cacheable memory first check the cache to see if the requested information is available. A *read hit* occurs if the information is available in the cache, and a *read miss* occurs if the information is not available. Likewise, a *write hit* occurs if the memory write can be stored in the cache, and a *write miss* occurs if it cannot be stored in the cache.

Caches are divided into fixed-size blocks called *cache lines*. The cache allocates lines to correspond to regions in memory of the same size as the cache line, aligned on an address boundary equal to the cache-line size. For example, in a cache with 32-byte lines, the cache lines are aligned on 32-byte boundaries and byte addresses 0007h and 001Eh are both located in the same cache line. The size of a cache line is implementation dependent. Most implementations have either 32-byte or 64-byte cache lines.

The process of loading data into a cache is a *cache-line fill*. Even if only a single byte is requested, all bytes in a cache line are loaded from memory. Typically, a cache-line fill must remove (evict) an existing cache line to make room for the new line loaded from memory. This process is called *cache-line replacement*. If the existing cache line was modified before the replacement, the processor performs a cache-line *writeback* to main memory when it performs the cache-line fill.

Cache-line writebacks help maintain *coherency* (consistency) between the caches and main memory. Internally, the processor can also maintain cache coherency by *internally probing* (checking) the other caches and write buffers for a more recent version of the requested data. External devices can also check processor caches for more recent versions of data by *externally probing* the processor. Throughout this document, the term *probe* is used to refer to external probes, while internal probes are always qualified with the word *internal*.

Write buffers temporarily hold data writes when main memory or the caches are busy with other memory accesses. The existence of write buffers is implementation dependent.

Implementations of the architecture can use *write-combining buffers* if the order and size of non-cacheable writes to main memory is not important to the operation of software. These buffers can combine multiple, individual writes to main memory and transfer the data in fewer bus transactions.

7.1 Single-Processor Memory Access Ordering

The flexibility in which memory accesses can be ordered is closely related to the flexibility in which a processor implementation can *execute* and *retire* instructions. Instruction execution *creates* results and status and determines whether or not the instruction causes an exception. Instruction retirement *commits* the results of instruction execution, in program order, to software-visible resources such as memory, caches, write-combining buffers, and registers, or it causes an exception to occur if instruction execution created one.

Implementations of the AMD64 architecture retire instructions in program order, but implementations can execute instructions in any order, subject only to data dependencies. Implementations can also *speculatively execute* instructions—executing instructions before knowing they are needed. Internally, implementations manage data reads and writes so that instructions complete in order. However, because implementations can execute instructions out of order and speculatively, the sequence of memory accesses performed by the hardware can appear to be out of program order. The following sections describe the rules governing memory accesses to which processor implementations adhere. These rules may be further restricted, depending on the memory type being accessed. Further, these rules govern single processor operation; see “Multiprocessor Memory Access Ordering” on page 164 for multiprocessor ordering rules.

7.1.1 Read Ordering

Generally, reads do not affect program order because they do not affect the state of software-visible resources other than register contents. However, some system devices might be sensitive to reads. In such a situation software can map a read-sensitive device to a memory type that enforces strong read-ordering, or use read/write barrier instructions to force strong read-ordering.

For cacheable memory types, the following rules govern read ordering:

- Out-of-order reads are allowed to the extent that they can be performed transparently to software, such that the appearance of in-order execution is maintained. Out-of-order reads can occur as a result of out-of-order instruction execution or speculative execution. The processor can read memory and perform cache refills out-of-order to allow out-of-order execution to proceed.
- Speculative reads are allowed. A speculative read occurs when the processor begins executing a memory-read instruction before it knows the instruction will actually complete. For example, the processor can predict a branch will occur and begin executing instructions following the predicted branch before it knows whether the prediction is valid. When one of the speculative instructions reads data from memory, the read itself is speculative. Cache refills may also be performed speculatively.
- Reads can be reordered ahead of writes. Reads are generally given a higher priority by the processor than writes because instruction execution stalls if the read data required by an instruction is not immediately available. Allowing reads ahead of writes usually maximizes software performance.
- A read *cannot* be reordered ahead of a prior write if the read is from the same location as the prior write. In this case, the read instruction stalls until the write instruction completes execution. The

read instruction requires the result of the write instruction for proper software operation. For cacheable memory types, the write data can be forwarded to the read instruction before it is actually written to memory.

7.1.2 Write Ordering

Writes affect program order because they affect the state of software-visible resources. The following rules govern write ordering:

- Generally, out-of-order writes are *not* allowed. Write instructions executed out of order cannot commit (write) their result to memory until all previous instructions have completed in program order. The processor can, however, hold the result of an out-of-order write instruction in a private buffer (not visible to software) until that result can be committed to memory.
- It is possible for writes to *write-combining* memory types to appear to complete out of order, relative to writes into other memory types. See “Memory Types” on page 170 and “Write Combining” on page 175 for additional information.
- Speculative writes are *not* allowed. As with out-of-order writes, speculative write instructions cannot commit their result to memory until all previous instructions have completed in program order. Processors can hold the result in a private buffer (not visible to software) until the result can be committed.
- Write buffering is allowed. When a write instruction completes and commits its result, that result can be buffered before actually writing the result into a memory location in program order. Although the write buffer itself is not directly accessible by software, the results in the buffer are accessible during memory accesses to the locations that are buffered. For cacheable memory types, the write buffer can be read out-of-order and speculatively read, just like memory.
- Write combining is allowed. In some situations software can relax the write-ordering rules and allow several writes to be combined into fewer writes to memory. When write-combining is used, it is possible for writes to other memory types to proceed ahead of (out-of-order) memory-combining writes, unless the writes are to the same address. Write-combining should be used only when the order of writes does not affect program order (for example, writes to a graphics frame buffer).

7.1.3 Read/Write Barriers

When the order of memory accesses must be strictly enforced, software can use read/write barrier instructions to force reads and writes to proceed in program order. Read/write barrier instructions force all prior reads or writes to complete before subsequent reads or writes are executed. The LFENCE, SFENCE, and MFENCE instructions are provided as dedicated read, write, and read/write barrier instructions (respectively). Serializing instructions, I/O instructions, and locked instructions can also be used as read/write barriers. Barrier instructions are useful for controlling ordering between differing memory types as well as within one memory type; see section 7.3.1 for details.

Table 7-1 on page 171 summarizes the memory-access ordering possible for each memory type supported by the AMD64 architecture.

7.2 Multiprocessor Memory Access Ordering

The term memory ordering refers to the sequence in which memory accesses are performed by the memory system, as observed by all processors or programs.

To improve performance of applications, AMD64 processors can speculatively execute instructions out of program order and temporarily hold out-of-order results. However, certain rules are followed with regard to normal cacheable accesses on naturally aligned boundaries to WB memory.

From the point of view of a program, in ascending order of priority:

- All loads, stores and I/O operations from a single processor appear to occur in program order to the code running on that processor and all instructions appear to execute in program order.

In this context:

- Loads do not pass previous loads (loads are not re-ordered). Stores do not pass previous stores (stores are not re-ordered)

In the examples below all memory values are initialized to zero.

Processor 0	Processor 1
Store A ← 1	Load B
Store B ← 1	Load A

Load A cannot read 0 when Load B reads 1. (This rule may be violated in the case of loads as part of a string operation, in which one iteration of the string reads 0 for Load A while another iteration reads 1 for Load B.)

- Stores do not pass loads

Processor 0	Processor 1
Load A	Load B
Store B ← 1	Store A ← 1

Load A and Load B cannot both read 1.

- Stores from a processor appear to be committed to the memory system in program order; however, stores can be delayed arbitrarily by store buffering while the processor continues operation. For the code example below, both load A in processor 1 and load B in processor 0 can read 1 from the first store in each processor. Therefore, stores from a processor may not appear to be sequentially consistent.

Processor 0	Processor 1
Store A ← 1	Store B ← 1
...	...
Store A ← 2	Store B ← 2
...	...
Load B	Load A

- Non-overlapping Loads may pass stores.

Processor 0	Processor 1
Store A ← 1	Store B ← 1
Load B	Load A

All combinations of Load A and Load B values are allowed. Where sequential consistency is needed (for example in Dekker's algorithm for mutual exclusion), an MFENCE instruction should be used between the store and the subsequent load, or a locked access, such as LOCK XCHG, should be used for the store.

Processor 0	Processor 1
Store A ← 1	Store B ← 1
MFENCE	MFENCE
Load B	Load A

Load A and Load B cannot both read 0.

- Stores to different locations in memory observed from two (or more) processors may be interleaved in different ways for different observers. In the code example,

Processor 0	Processor 1	Processor X	Processor Y
Store A ← 1	Store B ← 1		
		Load A (1)	Load B (1)
		Load B (0)	Load A (0)

processor X may see the store A from processor 0 before the store B from processor 1, while processor Y may see the store B from processor 1 before the store A from processor 0.

To provide a single point of global visibility, to enable processors X and Y to see the stores from processors 0 and 1 in the same order, locked accesses, which atomically load and store shared data (and provide sequential consistency), must be used for the stores, as follows.

Processor 0	Processor 1	Processor X	Processor Y
LOCK XCHG A, 1	LOCK XCHG B, 1		
		Load A (1)	Load B (1)
		Load B (0)	Load A (0)

The illustrated case—in which processor X may see LOCK XCHG A from processor 0 before LOCK XCHG B from processor 1, while processor Y may see LOCK XCHG B from processor 1 before LOCK XCHG A from processor 0—is *not* allowed.

- Dependent stores between different processors appear to occur in program order, as shown in the code example below.

Processor 0	Processor 1	Processor 2
Store A ← 1		
	Load A (1)	
	Store B ← 1	
		Load B (1)
		Load A (1)

If processor 1 reads a value from A (written by processor 0) before carrying out a store to B, and if processor 2 reads the updated value from B, a subsequent read of A must also be the updated value. A globally consistent ordering is maintained for such causally-related stores.

- There can be different points of visibility for a memory operation, including local (within a processor), non-local (within a subset of processors) and global (across the system). Using a data bypass, a local load can read the result of a local store in a store buffer, before the store becomes non-locally visible. Program order is still maintained when using such bypasses.

Processor 0	Processor 1
Store A ← 1	Store B ← 1
Load r1 A	Load r3 B
Load r2 B	Load r4 A

Load A in processor 0 can read 1 using the data bypass, while Load A in processor 1 can read 0. Similarly, Load B in processor 1 can read 1 while Load B in processor 0 can read 0. Therefore result r1 = 1, r2 = 0, r3 = 1 and r4 = 0 is allowed. There are no constraints on the relative order of Store A and Load A in processor 0, and store B and Load B in processor 1.

If a very strong memory ordering model is required that does not allow local store-load bypasses, an MFENCE instruction should be used between the store and the subsequent load or a synchronizing instruction such as LOCK XCHG should be used for the store. This memory ordering is stronger than total store ordering.

Processor 0	Processor 1
Store A ← 1	Store B ← 1
MFENCE	MFENCE
Load r1 A	Load r3 B
Load r2 B	Load r4 A

The MFENCE instruction ensures that any buffered stores are globally visible before the loads are allowed to execute, so the result $r1 = 1$, $r2 = 0$, $r3 = 1$ and $r4 = 0$ is not allowed. Similarly, a LOCK XCHG would ensure the loads don't execute until its store operation is globally visible.

7.3 Memory Coherency and Protocol

Implementations that support caching support a cache-coherency protocol for maintaining coherency between main memory and the caches. The cache-coherency protocol is also used to maintain coherency between all processors in a multiprocessor system. The cache-coherency protocol supported by the AMD64 architecture is the *MOESI* (modified, owned, exclusive, shared, invalid) protocol. The states of the MOESI protocol are:

- *Invalid*—A cache line in the invalid state does not hold a valid copy of the data. Valid copies of the data can be either in main memory or another processor cache.
- *Exclusive*—A cache line in the exclusive state holds the most recent, correct copy of the data. The copy in main memory is also the most recent, correct copy of the data. No other processor holds a copy of the data.
- *Shared*—A cache line in the shared state holds the most recent, correct copy of the data. Other processors in the system may hold copies of the data in the shared state, as well. If no other processor holds it in the *owned* state, then the copy in main memory is also the most recent.
- *Modified*—A cache line in the modified state holds the most recent, correct copy of the data. The copy in main memory is stale (incorrect), and no other processor holds a copy.
- *Owned*—A cache line in the owned state holds the most recent, correct copy of the data. The owned state is similar to the shared state in that other processors can hold a copy of the most recent, correct data. Unlike the shared state, however, the copy in main memory can be stale (incorrect). Only one processor can hold the data in the owned state—all other processors must hold the data in the shared state.

Figure 7-2 on page 168 shows the general MOESI state transitions possible with various types of memory accesses. This is a logical software view, not a hardware view, of how cache-line state transitions. Instruction-execution activity and external-bus transactions can both be used to modify the cache MOESI state in multiprocessing or multi-mastering systems.

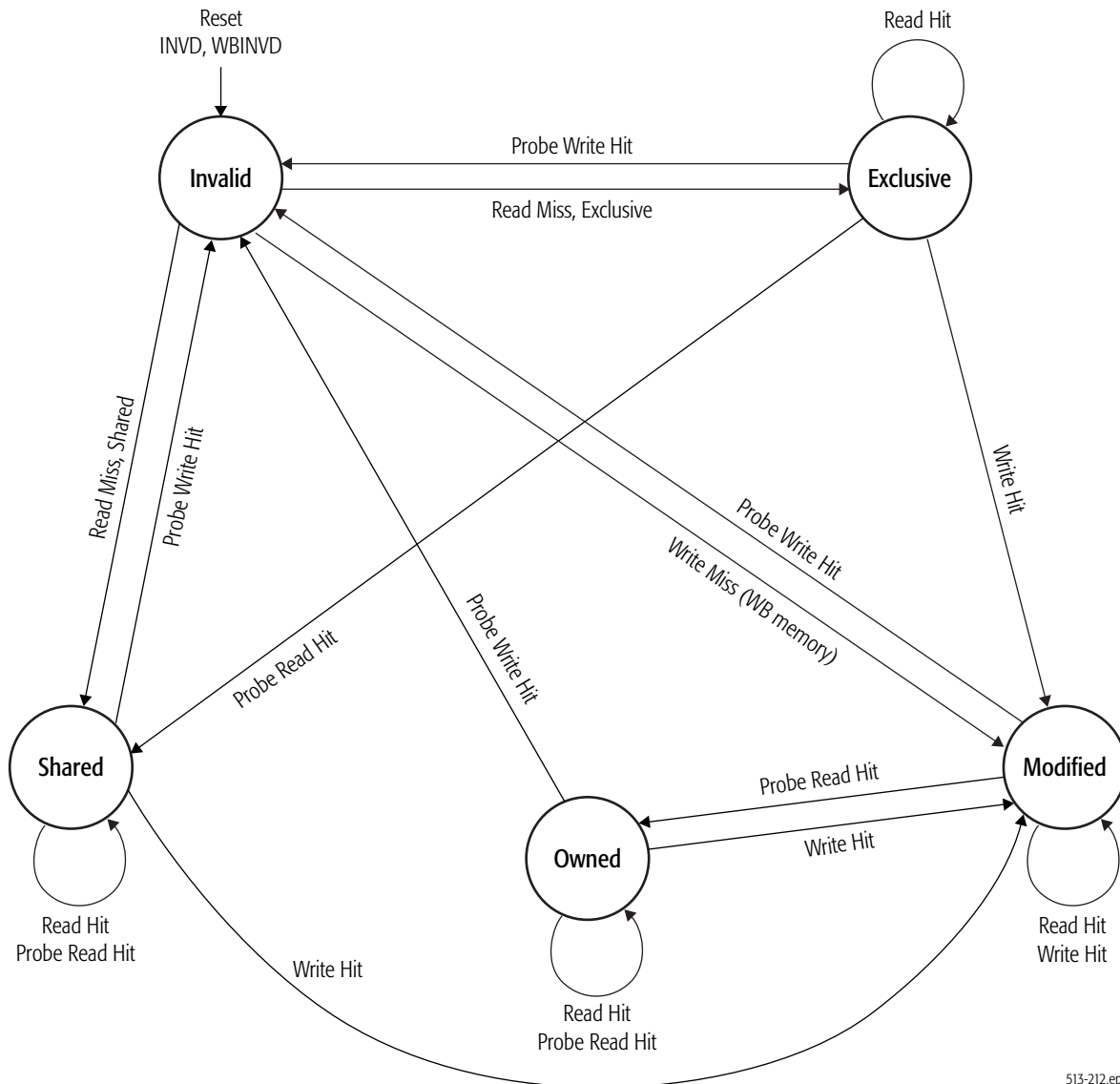

513-212.eps

Figure 7-2. MOESI State Transitions

To maintain memory coherency, external bus masters (typically other processors with their own internal caches) need to acquire the most recent copy of data before caching it internally. That copy can be in main memory or in the internal caches of other bus-mastering devices. When an external master has a cache read-miss or write-miss, it *probes* the other mastering devices to determine whether the most recent copy of data is held in any of their caches. If one of the other mastering devices holds the most recent copy, it provides it to the requesting device. Otherwise, the most recent copy is provided by main memory.

There are two general types of bus-master probes:

- Read probes indicate the external master is requesting the data for read purposes.
- Write probes indicate the external master is requesting the data for the purpose of modifying it.

Referring back to Figure 7-2 on page 168, the state transitions involving probes are initiated by other processors and external bus masters into the processor. Some read probes are initiated by devices that intend to cache the data. Others, such as those initiated by I/O devices, do not intend to cache the data. Some processor implementations do not change the data MOESI state if the read probe is initiated by a device that does not intend to cache the data.

State transitions involving read misses and write misses can cause the processor to generate probes into external bus masters and to read main memory.

Read hits do not cause a MOESI-state change. Write hits generally cause a MOESI-state change into the modified state. If the cache line is already in the modified state, a write hit does not change its state.

The specific operation of external-bus signals and transactions and how they influence a cache MOESI state are implementation dependent. For example, an implementation could convert a write miss to a WB memory type into two separate MOESI-state changes. The first would be a read-miss placing the cache line in the exclusive state. This would be followed by a write hit into the exclusive cache line, changing the cache-line state to modified.

7.3.1 Special Coherency Considerations

In some cases, data can be modified in a manner that is impossible for the memory-coherency protocol to handle due to the effects of instruction prefetching. In such situations software must use serializing instructions and/or cache-invalidation instructions to guarantee subsequent data accesses are coherent.

An example of this type of a situation is a page-table update followed by accesses to the physical pages referenced by the updated page tables. The following sequence of events shows what can happen when software changes the translation of virtual-page *A* from physical-page *M* to physical-page *N*:

1. Software invalidates the TLB entry. The tables that translate virtual-page *A* to physical-page *M* are now held only in main memory. They are not cached by the TLB.
2. Software changes the page-table entry for virtual-page *A* in main memory to point to physical-page *N* rather than physical-page *M*.
3. Software accesses data in virtual-page *A*.

During Step 3, software expects the processor to access the data from physical-page *N*. However, it is possible for the processor to prefetch the data from physical-page *M* before the page table for virtual-page *A* is updated in Step 2. This is because the physical-memory references for the *page tables* are different than the physical-memory references for the *data*. Because the physical-memory references are different, the processor does not recognize them as requiring coherency checking and believes it is safe to prefetch the data from virtual-page *A*, which is translated into a read from physical page *M*. Similar behavior can occur when instructions are prefetched from beyond the page table update instruction.

To prevent this problem, software must use an INVLPG or MOV CR3 instruction immediately after the page-table update to ensure that subsequent instruction fetches and data accesses use the correct virtual-page-to-physical-page translation. It is not necessary to perform a TLB invalidation operation preceding the table update.

7.4 Memory Types

The AMD64 architecture defines the following memory types:

- *Uncacheable (UC)*—Reads from, and writes to, UC memory are not cacheable. Reads from UC memory cannot be speculative. Write-combining to UC memory is not allowed. Reads from UC memory cause the write buffers to be written to memory and invalidated.

The UC memory type is useful for memory-mapped I/O devices where strict ordering of reads and writes is important.

- *Cache Disable (CD)*—The CD memory type is a form of uncacheable memory type that occurs when caches are disabled (CR0.CD=1). With CD memory, it is possible for the address to be cached due to an earlier cacheable access, or due to two virtual-addresses aliasing to a single physical address.

For the L1 data cache and the L2 cache, reads from, and writes to, CD memory that hit the cache cause the cache line to be invalidated before accessing main memory. If the cache line is in the modified state, the line is written to main memory and then invalidated.

For the L1 instruction cache, reads from CD memory that hit the cache read the cached instructions rather than access main memory. Reads that miss the cache access main memory and do not cause cache-line replacement.

- *Write-Combining (WC)*—Reads from, and writes to, WC memory are not cacheable. Reads from WC memory can be speculative.

Writes to this memory type can be combined internally by the processor and written to memory as a single write operation to reduce memory accesses. For example, four word writes to consecutive addresses can be combined by the processor into a single quadword write, resulting in one memory access instead of four.

The WC memory type is useful for graphics-display memory buffers where the order of writes is not important.

- *Write-Protect (WP)*—Reads from WP memory are cacheable and allocate cache lines on a read miss. Reads from WP memory can be speculative.

Writes to WP memory that hit in the cache do not update the cache. Instead, all writes update memory (write to memory), and writes that hit in the cache invalidate the cache line. Write buffering of WP memory is allowed.

The WP memory type is useful for shadowed-ROM memory where updates must be immediately visible to all devices that read the shadow locations.

- *Writethrough (WT)*—Reads from WT memory are cacheable and allocate cache lines on a read miss. Reads from WT memory can be speculative.

All writes to WT memory update main memory, and writes that hit in the cache update the cache line (cache lines remain in the same state after a write that hits a cache line). Writes that miss the cache do not allocate a cache line. Write buffering of WT memory is allowed.

- *Writeback (WB)*—Reads from WB memory are cacheable and allocate cache lines on a read miss. Cache lines can be allocated in the shared, exclusive, or modified states. Reads from WB memory can be speculative.

All writes that hit in the cache update the cache line and place the cache line in the modified state. Writes that miss the cache allocate a new cache line and place the cache line in the modified state. Writes to main memory only take place during writeback operations. Write buffering of WB memory is allowed.

The WB memory type provides the highest-possible performance and is useful for most software and data stored in system memory (DRAM).

Table 7-1 shows the memory access ordering possible for each memory type supported by the AMD64 architecture. Table 7-3 on page 173 shows the ordering behavior of various operations on various memory types in greater detail. Table 7-2 on page 172 shows the caching policy for the same memory types.

Table 7-1. Memory Access by Memory Type

Memory Access Allowed		Memory Type				
		UC/CD	WC	WP	WT	WB
Read	Out-of-Order	no	yes	yes	yes	yes
	Speculative	no	yes	yes	yes	yes
	Reorder Before Write	no	yes	yes	yes	yes
Write	Out-of-Order	no	yes	no	no	no
	Speculative	no	no	no	no	no
	Buffering	no	yes	yes	yes	yes
	Combining ¹	no	yes	no	yes	yes

Note:
1. Write-combining buffers are separate from write buffers.

Table 7-2. Caching Policy by Memory Type

Caching Policy	Memory Type					
	UC	CD	WC	WP	WT	WB
Read Cacheable	no	no	no	yes	yes	yes
Write Cacheable	no	no	no	no	yes	yes
Read Allocate	no	no	no	yes	yes	yes
Write Allocate	no	no	no	no	no	yes
Write Hits Update Memory	yes ²	yes ¹	yes ²	yes ³	yes	no

Note:

1. For the L1 data cache and the L2 cache, if an access hits the cache, the cache line is invalidated. If the cache line is in the modified state, the line is written to main memory and then invalidated. For the L1 instruction cache, read hits access the cache rather than main memory.
2. The data is not cached, so a cache write hit cannot occur. However, memory is updated.
3. Write hits update memory and invalidate the cache line.

7.4.1 Memory Barrier Interaction with Memory Types

Memory types other than WB may allow weaker ordering in certain respects. When the ordering of memory accesses to differing memory types must be strictly enforced, software can use the LFENCE, MFENCE or SFENCE barrier instructions to force loads and stores to proceed in program order. Table 7-3 on page 173 summarizes the cases where a memory barrier must be inserted between two memory operations.

The table is read as follows: the ROW is the first memory operation in program order, followed by the COLUMN, which is the second memory operation in program order. The footnotes indicate the rules for memory ordering.

Table 7-3. Memory Access Ordering Rules

First Memory Operation	Second Memory Operation								
	Load (wp, wt, wb)	Load (uc)	Load (wc, wc+)	Store (wp, wt, wb)	Store (uc)	Store (wc, wc+, non-temporal)	Load/Store (io)	Lock (atomic)	Serialize instructions/Interrupts/Exceptions
Load (wp, wt, wb)	a	a	b (lf)	c	c	c	d	d	d
Load (uc)	a	a	b (lf)	c	c	c	d	d	d
Load (wc, wc+)	a	a	b (lf)	c	c	c	d	d	d
Store (wp, wt, wb)	e (mf)	f	e (mf)	g	g	h (sf)	d	d	d
Store (uc)	i	f	i	g	g	h (sf)	d	d	d
Store (wc, wc+, non-temporal)	e (mf)	f	e (mf)	j (sf)	j (sf)	h (sf)	d	d	d
Load/Store (io)	k	k	k	k	k	l	d, k	d, k	d, k
Lock (atomic)	k	k	k	k	k	k	d, k	d, k	d, k
Serialize instruction/Interrupts/Exceptions	l	l	l	l	l	l	d, l	d, l	d, l

- a — A load (wp,wt,wb,wc,wc+) may pass a previous non-conflicting store (wp,wt,wb,wc,wc+).
- b — A load (wc,wc+) may pass a previous load (wp,wt,wb,uc,wc,wc+). To ensure memory order, an LFENCE instruction must be inserted between the two loads.
- c — A store (wp,wt,wb,uc,wc,wc+) may not pass a previous load (wp,wt,wb,uc,wc,wc+).
- d — All previous loads and stores complete to memory or I/O space before a memory access for an I/O, locked or serializing instruction is issued.
- e — A load (wp,wt,wb,wc,wc+) may pass a previous non-conflicting store (wp,wt,wb,wc,wc+). To ensure memory order, an MFENCE instruction must be inserted between the store and the load.
- f — A load (uc) does not pass a previous store (wp,wt,wb,uc,wc,wc+).
- g — A store (wp,wt,wb,uc) does not pass a previous store (wp,wt,wb,uc).
- h — A store (wc,wc+) may pass a previous store (wp,wt,wb,uc) or non-conflicting store (wc,wc+). To ensure memory order, an SFENCE instruction must be inserted between these two stores. A store (wc,wc+) does not pass a previous conflicting store (wc,wc+).
- i — A load (wp,wt,wb,wc,wc+) does not pass a previous store (uc).
- j — A store (wp,wt,wb,uc) may pass a previous store (wc,wc+). To ensure memory order, an SFENCE instruction must be inserted between these two stores.
- k — All loads and stores associated with the I/O and locked instructions complete to memory (no buffered stores) before a load or store from a subsequent instruction is issued.
- l — All loads and stores complete to memory for the serializing instruction before the subsequent instruction fetch is issued.

7.5 Buffering and Combining Memory Writes

7.5.1 Write Buffering

Writes to memory (main memory and caches) can be stored internally by the processor in *write buffers* (also known as store buffers) before actually writing the data into a memory location. System performance can be improved by buffering writes, as shown in the following examples:

- When higher-priority memory transactions, such as reads, compete for memory access with writes, writes can be delayed in favor of reads, which minimizes or eliminates an instruction-execution stall due to a memory-operand read.
- When the memory is busy, buffering writes while the memory is busy removes the writes from the instruction-execution pipeline, which frees instruction-execution resources.

The processor manages the write buffer so that it is transparent to software. Memory accesses check the write buffer, and the processor completes writes into memory from the buffer in program order. Also, the processor completely empties the write buffer by writing the contents to memory as a result of performing any of the following operations:

- *SFENCE Instruction*—Executing a store-fence (SFENCE) instruction forces all memory writes before the SFENCE (in program order) to be written into memory (or, for WB type, the cache) before memory writes that follow the SFENCE instruction. The memory-fence (MFENCE) instruction has a similar effect, but it forces the ordering of loads in addition to stores.
- *Serializing Instructions*—Executing a serializing instruction forces the processor to retire the serializing instruction (complete both instruction execution and result writeback) before the next instruction is fetched from memory.
- *I/O instructions*—Before completing an I/O instruction, all previous reads and writes must be written to memory, and the I/O instruction must complete before completing subsequent reads or writes. Writes to I/O-address space (OUT instruction) are never buffered.
- *Locked Instructions*—A locked instruction (an instruction executed using the LOCK prefix) must complete *after* all previous reads and writes and *before* subsequent reads and writes. Locked writes are never buffered, although locked reads and writes are cacheable.
- *Interrupts and Exceptions*—Interrupts and exceptions are serializing events that force the processor to write all results from the write buffer to memory before fetching the first instruction from the interrupt or exception service routine.
- *UC-Memory Reads*—UC-memory reads are not reordered ahead of writes.

Write buffers can behave similarly to *write-combining buffers* because multiple writes may be collected internally before transferring the data to caches or main memory. See the following section for a description of write combining.

7.5.2 Write Combining

Write-combining memory uses a different buffering scheme than write buffering described above. Writes to write-combining (WC) memory can be combined internally by the processor in a buffer for more efficient transfer to main memory at a later time. For example, 16 doubleword writes to consecutive memory addresses can be combined in the WC buffers and transferred to main memory as a single burst operation rather than as individual memory writes.

The following instructions perform writes to WC memory:

- MASKMOVDQU
- MASKMOVQ
- MOVNTDQ
- MOVNTI
- MOVNTPD
- MOVNTPS
- MOVNTQ
- MOVNTSD
- MOVNTSS

WC memory is not cacheable. A WC buffer writes its contents only to main memory.

The size and number of WC buffers available is implementation dependent. The processor assigns an address range to an empty WC buffer when a WC-memory write occurs. The size and alignment of this address range is equal to the buffer size. All subsequent writes to WC memory that fall within this address range can be stored by the processor in the WC-buffer entry until an event occurs that causes the processor to write the WC buffer to main memory. After the WC buffer is written to main memory, the processor can assign a new address range on a subsequent WC-memory write.

Writes to consecutive addresses in WC memory are not required for the processor to combine them. The processor combines any WC memory write that falls within the active-address range for a buffer. Multiple writes to the same address overwrite each other (in program order) until the WC buffer is written to main memory.

It is possible for writes to proceed out of program order when WC memory is used. For example, a write to cacheable memory that follows a write to WC memory can be written into the cache before the WC buffer is written to main memory. For this reason, and the reasons listed in the previous paragraph, software that is sensitive to the order of memory writes should avoid using WC memory.

WC buffers are written to main memory under the same conditions as the write buffers, namely when:

- Executing a store-fence (SFENCE) instruction.
- Executing a serializing instruction.
- Executing an I/O instruction.
- Executing a locked instruction (an instruction executed using the LOCK prefix).

- An interrupt or exception occurs.

WC buffers are also written to main memory when:

- A subsequent non-write-combining operation has a write address that matches the WC-buffer active-address range.
- A write to WC memory falls outside the WC-buffer active-address range. The existing buffer contents are written to main memory, and a new address range is established for the latest WC write.

7.6 Memory Caches

The AMD64 architecture supports the use of internal and external caches. The size, organization, coherency mechanism, and replacement algorithm for each cache is implementation dependent. Generally, the existence of the caches is transparent to both application and system software. In some cases, however, software can use cache-structure information to optimize memory accesses or manage memory coherency. Such software can use the extended-feature functions of the CPUID instruction to gather information on the caching subsystem supported by the processor. For more information on using CPUID in this manner, see the *CPUID Specification*, order# 25481.

7.6.1 Cache Organization and Operation

Although the detailed organization of a processor cache depends on the implementation, the general constructs are similar. L1 caches—data and instruction, or unified—and L2 caches usually are implemented as n-way set-associative caches. Figure 7-3 on page 177 shows a typical *logical* organization of an n-way set-associative cache. The physical implementation of the cache can be quite different.

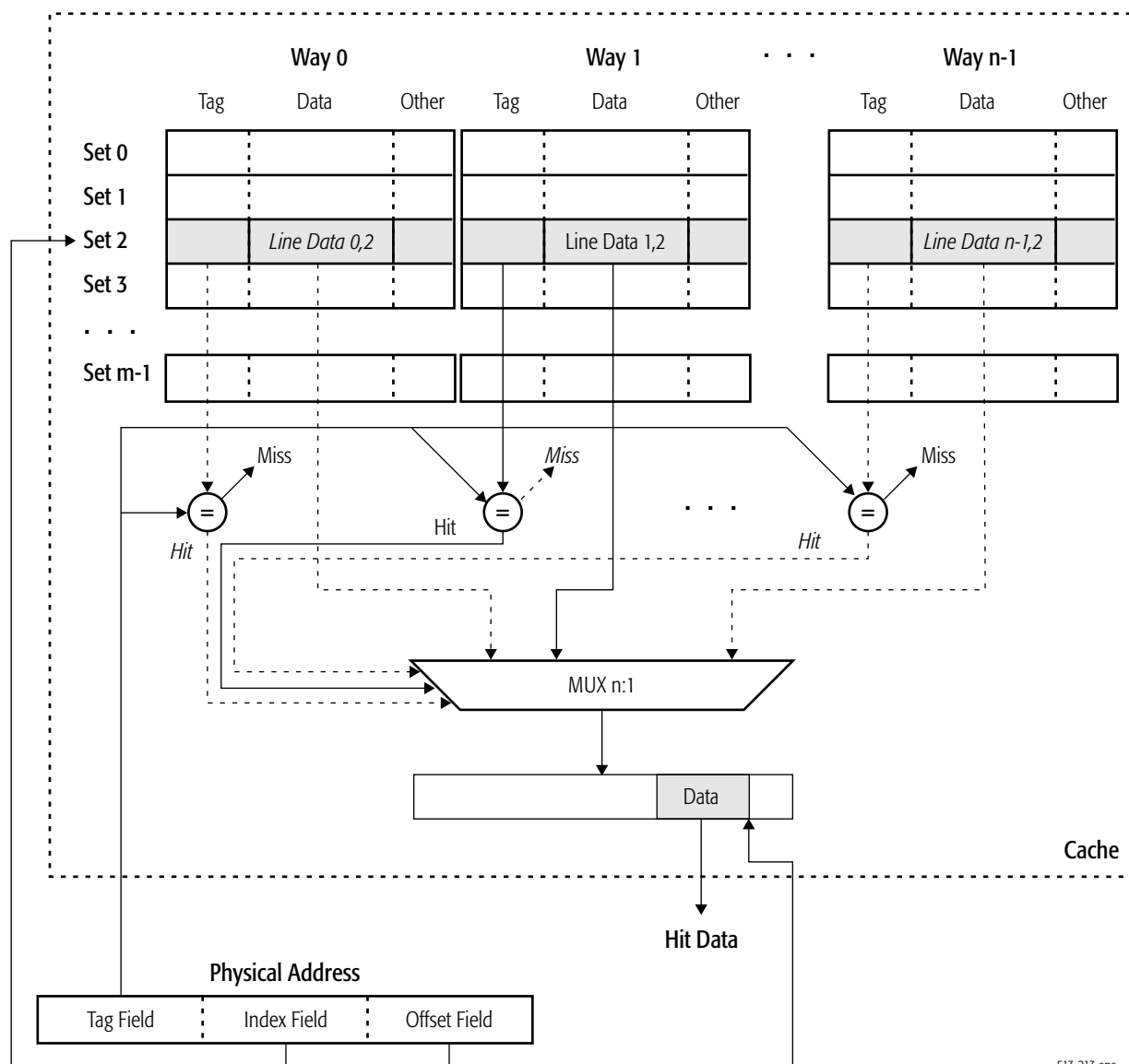

513-213.eps

Figure 7-3. Cache Organization Example

As shown in Figure 7-3, the cache is organized as an array of cache lines. Each cache line consists of three parts: a cache-data line (a fixed-size copy of a memory block), a tag, and other information. Rows of cache lines in the cache array are *sets*, and columns of cache lines are *ways*. In an n-way set-associative cache, each set is a collection of n lines. For example, in a four-way set-associative cache, each set is a collection of four cache lines, one from each way.

The cache is accessed using the physical address of the data or instruction being referenced. To access data within a cache line, the physical address is used to select the set, way, and byte from the cache. This is accomplished by dividing the physical address into the following three fields:

- *Index*—The *index field* selects the cache set (row) to be examined for a hit. All cache lines within the set (one from each way) are selected by the index field.
- *Tag*—The *tag field* is used to select a specific cache line from the cache set. The physical-address tag field is compared with each cache-line tag in the set. If a match is found, a cache hit is signalled, and the appropriate cache line is selected from the set. If a match is not found, a cache miss is signalled.
- *Offset*—The *offset field* points to the first byte in the cache line corresponding to the memory reference. The referenced data or instruction value is read from (or written to, in the case of memory writes) the selected cache line starting at the location selected by the offset field.

In Figure 7-3 on page 177, the physical-address index field is shown selecting Set 2 from the cache. The tag entry for each cache line in the set is compared with the physical-address tag field. The tag entry for Way 1 matches the physical-address tag field, so the cache-line data for Set 2, Way 1 is selected using the n:1 multiplexor. Finally, the physical-address offset field is used to point to the first byte of the referenced data (or instruction) in the selected cache line.

Cache lines can contain other information in addition to the data and tags, as shown in Figure 7-3 on page 177. MOESI state and the state bits associated with the cache-replacement algorithm are typical pieces of information kept with the cache line. Instruction caches can also contain pre-decode or branch-prediction information. The type of information stored with the cache line is implementation dependent.

Self-Modifying Code. Software that writes into the code segment from which it was fetched is classified as self-modifying code. To avoid cache-coherency problems due to self-modifying code, a check is made during data writes to see whether the data-memory location corresponds to a code-segment memory location. If it does, implementations of the AMD64 architecture invalidate the corresponding *instruction-cache* line(s) during the data-memory write. Entries in the data cache are not invalidated, and it is possible for the modified instruction to be cached by the data cache following the memory write. A subsequent fetch of the modified instruction goes to main memory to get the coherent version of the instruction. If the data cache holds the most recent copy of the instruction rather than main memory, it provides that copy.

The processor determines whether a write is in a code segment by internally probing the instruction cache and prefetched instructions. If the internal probe returns a hit, the instruction-cache line and prefetched instructions are invalidated. The internal probes into the instruction cache and prefetch hardware are always performed using the *physical address* of an instruction in order to avoid potential aliasing problems associated with using virtual (linear) addresses.

Software that stores into a code segment running simultaneously on another processor with the intent that the other processor execute the written data as code is classified as cross-modifying code. To avoid cache-coherency issues when using cross-modifying code, the processor doing the store should

provide synchronization between the processors using locked semaphores. Synchronization for cross-modifying code is *not* required for code that resides within the naturally aligned quadword.

7.6.2 Cache Control Mechanisms

The AMD64 architecture provides a number of mechanisms for controlling the cacheability of memory. These are described in the following sections.

Cache Disable. Bit 30 of the CR0 register is the cache-disable bit, CR0.CD. Caching is enabled when CR0.CD is cleared to 0, and caching is disabled when CR0.CD is set to 1. When caching is disabled, reads and writes access main memory.

Software can disable the cache while the cache still holds valid data (or instructions). If a read or write hits the L1 data cache or the L2 cache when CR0.CD=1, the processor does the following:

1. Writes the cache line back if it is in the modified or owned state.
2. Invalidates the cache line.
3. Performs a non-cacheable main-memory access to read or write the data.

If an instruction fetch hits the L1 instruction cache when CR0.CD=1, the processor reads the cached instructions rather than access main memory.

The processor also responds to cache probes when CR0.CD=1. Probes that hit the cache cause the processor to perform Step 1. Step 2 (cache-line invalidation) is performed only if the probe is performed on behalf of a memory write or an exclusive read.

Writethrough Disable. Bit 29 of the CR0 register is the *not writethrough* disable bit, CR0.NW. In early x86 processors, CR0.NW is used to control cache writethrough behavior, and the combination of CR0.NW and CR0.CD determines the cache operating mode.

In early x86 processors, clearing CR0.NW to 0 enables writeback caching for main memory, effectively disabling writethrough caching for main memory. When CR0.NW=0, software can disable writeback caching for specific memory pages or regions by using other cache control mechanisms. When software sets CR0.NW to 1, writeback caching is disabled for main memory, while writethrough caching is enabled.

In implementations of the AMD64 architecture, CR0.NW is not used to qualify the cache operating mode established by CR0.CD. Table 7-4 shows the effects of CR0.NW and CR0.CD on the AMD64 architecture cache-operating modes.

Table 7-4. AMD64 Architecture Cache-Operating Modes

CR0.CD	CR0.NW	Cache Operating Mode
0	0	Cache enabled with a writeback-caching policy.
0	1	Invalid setting—causes a general-protection exception (#GP).
1	0	Cache disabled. See “Cache Disable” on page 179.
1	1	

Page-Level Cache Disable. Bit 4 of all paging data-structure entries controls page-level cache disable (PCD). When a data-structure-entry PCD bit is cleared to 0, the page table or physical page pointed to by that entry is cacheable, as determined by the CR0.CD bit. When the PCD bit is set to 1, the page table or physical page is not cacheable. The PCD bit in the paging data-structure base-register (bit 4 in CR3) controls the cacheability of the highest-level page table in the page-translation hierarchy.

Page-Level Writethrough Enable. Bit 3 of all paging data-structure entries is the page-level writethrough enable control (PWT). When a data-structure-entry PWT bit is cleared to 0, the page table or physical page pointed to by that entry has a writeback caching policy. When the PWT bit is set to 1, the page table or physical page has a writethrough caching policy. The PWT bit in the paging data-structure base-register (bit 3 in CR3) controls the caching policy of the highest-level page table in the page-translation hierarchy.

The corresponding PCD bit must be cleared to 0 (page caching enabled) for the PWT bit to have an effect.

Memory Typing. Two mechanisms are provided for software to control access to and cacheability of specific memory regions:

- The memory-type range registers (MTRRs) control cacheability based on physical addresses. See “MTRRs” on page 184 for more information on the use of MTRRs.
- The page-attribute table (PAT) mechanism controls cacheability based on virtual addresses. PAT extends the capabilities provided by the PCD and PWT page-level cache controls. See “Page-Attribute Table Mechanism” on page 193 for more information on the use of the PAT mechanism.

System software can combine the use of both the MTRRs and PAT mechanisms to maximize control over memory cacheability.

If the MTRRs are disabled in implementations that support the MTRR mechanism, the default memory type is set to uncacheable (UC). Memory accesses are not cached even if the caches are enabled by clearing CR0.CD to 0. Cacheable memory types must be established using the MTRRs in order for memory accesses to be cached.

Cache Control Precedence. The cache-control mechanisms are used to define the memory type and cacheability of main memory and regions of main memory. Taken together, the most restrictive memory type takes precedence in defining the caching policy of memory. The order of precedence is:

1. Uncacheable (UC)
2. Write-combining (WC)
3. Write-protected (WP)
4. Writethrough (WT)
5. Writeback (WB)

For example, assume a large memory region is designated a writethrough type using the MTRRs. Individual pages within that region can have caching disabled by setting the appropriate page-table

PCD bits. However, no pages within that region can have a writeback caching policy, regardless of the page-table PWT values.

7.6.3 Cache and Memory Management Instructions

Data Prefetch. The prefetch instructions are used by software as a hint to the processor that the referenced data is likely to be used in the near future. The processor can preload the cache line containing the data in anticipation of its use. PREFETCH provides a hint that the data is to be read. PREFETCHW provides a hint that the data is to be written. The processor can mark the line as modified if it is preloaded using PREFETCHW.

Memory Ordering. Instructions are provided for software to enforce memory ordering (serialization) in weakly-ordered memory types. These instructions are:

- *SFENCE* (*store fence*)—forces all memory writes (stores) preceding the SFENCE (in program order) to be written into memory before memory writes following the SFENCE.
- *LFENCE* (*load fence*)—forces all memory reads (loads) preceding the LFENCE (in program order) to be read from memory before memory reads following the LFENCE.
- *MFENCE* (*memory fence*)—forces all memory accesses (reads and writes) preceding the MFENCE (in program order) to be written into or read from memory before memory accesses following the MFENCE.

Cache Line Flush. The CLFLUSH instruction (writeback, if modified, and invalidate) takes the byte memory-address operand (a linear address), and checks to see if the address is cached. If the address is cached, the entire cache line containing the address is invalidated. If any portion of the cache line is dirty (in the modified or owned state), the entire line is written to main memory before it is invalidated. CLFLUSH affects *all caches* in the memory hierarchy—internal and external to the processor. The checking and invalidation process continues until the address has been invalidated in all caches.

In most cases, the underlying memory type assigned to the address has no effect on the behavior of this instruction. However, when the underlying memory type for the address is UC or WC (as defined by the MTRRs), the processor does not proceed with checking all caches to see if the address is cached. In both cases, the address is uncacheable, and invalidation is unnecessary. Write-combining buffers are written back to memory if the corresponding physical address falls within the buffer active-address range.

Cache Writeback and Invalidate. Unlike the CLFLUSH instruction, the WBINVD instruction operates on the entire cache, rather than a single cache line. The WBINVD instruction first writes back all cache lines that are dirty (in the modified or owned state) to main memory. After writeback is complete, the instruction invalidates all cache lines. The checking and invalidation process continues until all internal caches are invalidated. A special bus cycle is transmitted to higher-level external caches directing them to perform a writeback-and-invalidate operation.

Cache Invalidate. The INVD instruction is used to invalidate all cache lines. Unlike the WBINVD instruction, dirty cache lines are not written to main memory. The process continues until all internal caches have been invalidated. A special bus cycle is transmitted to higher-level external caches directing them to perform an invalidation.

The INVD instruction should only be used in situations where memory coherency is not required.

7.6.4 Serializing Instructions

Serializing instructions force the processor to retire the serializing instruction and all previous instructions before the next instruction is fetched. A serializing instruction is retired when the following operations are complete:

- The instruction has executed.
- All registers modified by the instruction are updated.
- All memory updates performed by the instruction are complete.
- All data held in the write buffers have been written to memory.

Serializing instructions can be used as a barrier between memory accesses to force strong ordering of memory operations. Care should be exercised in using serializing instructions because they modify processor state and affect program flow. The instructions also force execution serialization, which can significantly degrade performance. When strongly-ordered memory accesses are required, but execution serialization is not, it is recommended that software use the memory-ordering instructions described on page 181.

The following are serializing instructions:

- *Non-Privileged Instructions*
 - CPUID
 - IRET
 - RSM
- *Privileged Instructions*
 - MOV CR_n
 - MOV DR_n
 - LGDT, LIDT, LLDT, LTR
 - SWAPGS
 - WRMSR
 - WBINVD, INVD
 - INVLPG

7.7 Memory-Type Range Registers

The AMD64 architecture supports three mechanisms for software access-control and cacheability-control over memory regions. These mechanisms can be used in place of similar capabilities provided by external chipsets used with early x86 processors.

This section describes a control mechanism that uses a set of programmable model-specific registers (MSRs) called the *memory-type-range registers* (MTRRs). The MTRR mechanism provides system software with the ability to manage hardware-device memory mapping. System software can characterize physical-memory regions by type (e.g., ROM, flash, memory-mapped I/O) and assign hardware devices to the appropriate physical-memory type.

Another control mechanism is implemented as an extension to the page-translation capability and is called the *page attribute table* (PAT). It is described in “Page-Attribute Table Mechanism” on page 193. Like the MTRRs, PAT provides system software with the ability to manage hardware-device memory mapping. With PAT, however, system software can characterize physical pages and assign virtually-mapped devices to those physical pages using the page-translation mechanism. PAT may be used in conjunction with the MTRR mechanism to maximize flexibility in memory control.

Finally, control mechanisms are provided for managing memory-mapped I/O. These mechanisms employ extensions to the MTRRs and a separate feature called the *top-of-memory registers*. The MTRR extensions include additional MTRR type-field encodings for fixed-range MTRRs and variable-range I/O range registers (IORRs). These mechanisms are described in “Memory-Mapped I/O” on page 197.

7.7.1 MTRR Type Fields

The MTRR mechanism provides a means for associating a physical-address range with a memory type (see “Memory Types” on page 170). The MTRRs contain a type field used to specify the memory type in effect for a given physical-address range.

There are two variants of the memory type-field encodings: standard and extended. Both the standard and extended encodings use type-field bits 2–0 to specify the memory type. For the standard encodings, bits 7–3 are reserved and must be zero. For the extended encodings, bits 7–5 are reserved, but bits 4–3 are defined as the RdMem and WrMem bits. “Extended Fixed-Range MTRR Type-Field Encodings” on page 197 describes the function of these extended bits and how software enables them. Only the fixed-range MTRRs support the extended type-field encodings. Variable-range MTRRs use the standard encodings.

Table 7-5 on page 184 shows the memory types supported by the MTRR mechanism and their encoding in the MTRR type fields referenced throughout this section. Unless the extended type-field encodings are explicitly enabled, the processor uses the type values shown in Table 7-5.

Table 7-5. MTRR Type Field Encodings

Type Value	Type Name	Type Description
00h	UC—Uncacheable	All accesses are uncacheable. Write combining is not allowed. Speculative accesses are not allowed
01h	WC—Write-Combining	All accesses are uncacheable. Write combining is allowed. Speculative reads are allowed
04h	WT—Writethrough	Reads allocate cache lines on a cache miss. Cache lines are not allocated on a write miss. Write hits update the cache and main memory.
05h	WP—Write-Protect	Reads allocate cache lines on a cache miss. All writes update main memory. Cache lines are not allocated on a write miss. Write hits invalidate the cache line and update main memory.
06h	WB—Writeback	Reads allocate cache lines on a cache miss, and can allocate to either the shared, exclusive, or modified state. Writes allocate to the modified state on a cache miss.

If the MTRRs are disabled in implementations that support the MTRR mechanism, the default memory type is set to uncacheable (UC). *Memory accesses are not cached even if the caches are enabled by clearing CR0.CD to 0.* Cacheable memory types must be established using the MTRRs to enable memory accesses to be cached.

7.7.2 MTRRs

Both fixed-size and variable-size address ranges are supported by the MTRR mechanism. The fixed-size ranges are restricted to the lower 1 Mbyte of physical-address space, while the variable-size ranges can be located anywhere in the physical-address space.

Figure 7-4 on page 185 shows an example mapping of physical memory using the fixed-size and variable-size MTRRs. The areas shaded gray are not mapped by the MTRRs. Unmapped areas are set to the software-selected default memory type.

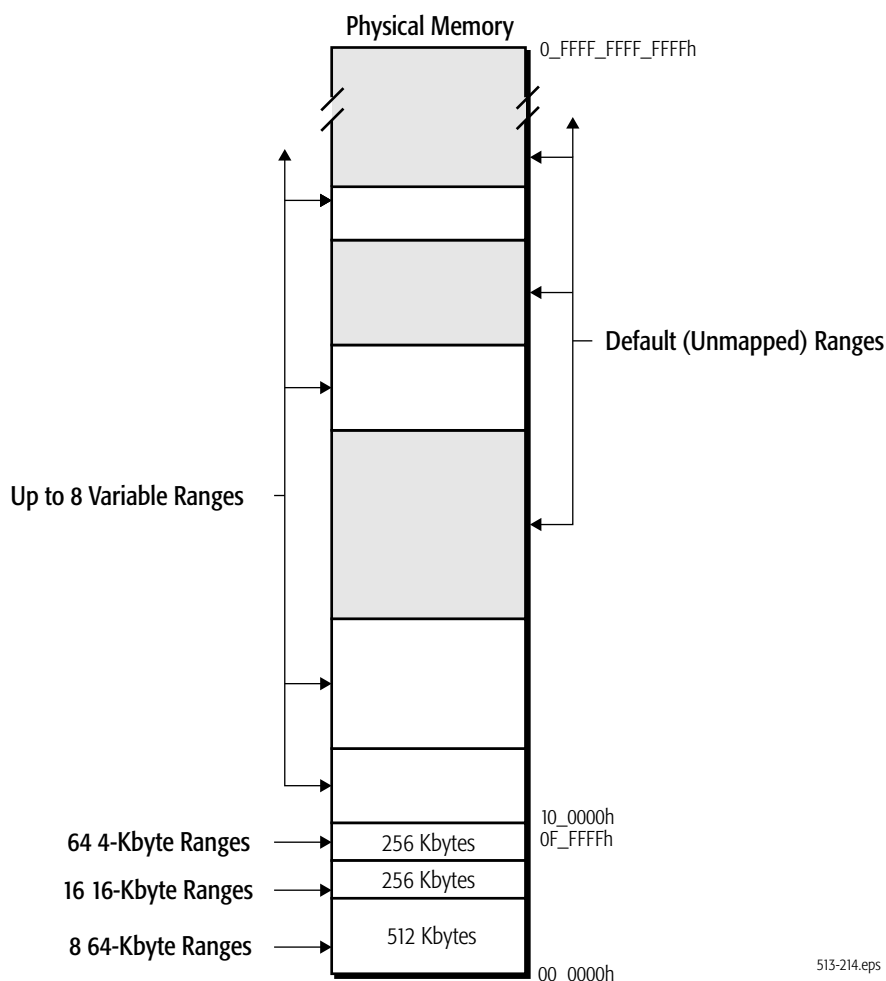

Figure 7-4. MTRR Mapping of Physical Memory

MTRRs are 64-bit model-specific registers (MSRs). They are read using the RDMSR instruction and written using the WRMSR instruction. See “Memory-Typing MSRs” on page 464 for a listing of the MTRR MSR numbers. The following sections describe the types of MTRRs and their function.

Fixed-Range MTRRs. The fixed-range MTRRs are used to characterize the first 1 Mbyte of physical memory. Each fixed-range MTRR contains eight type fields for characterizing a total of eight memory ranges. Fixed-range MTRRs support extended type-field encodings as described in “Extended Fixed-Range MTRR Type-Field Encodings” on page 197. The extended type field allows a fixed-range MTRR to be used as a fixed-range IORR. Figure 7-5 on page 186 shows the format of a fixed-range MTRR.

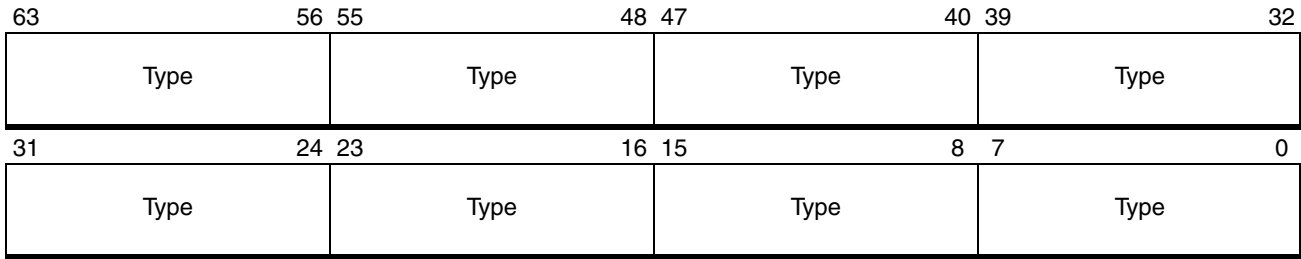

Figure 7-5. Fixed-Range MTRR

For the purposes of memory characterization, the first 1 Mbyte of physical memory is segmented into a total of 88 non-overlapping memory ranges, as follows:

- The 512 Kbytes of memory spanning addresses 00_0000h to 07_FFFFh are segmented into eight 64-Kbyte ranges. A single MTRR is used to characterize this address space.
- The 256 Kbytes of memory spanning addresses 08_0000h to 0B_FFFFh are segmented into 16 16-Kbyte ranges. Two MTRRs are used to characterize this address space.
- The 256 Kbytes of memory spanning addresses 0C_0000h to 0F_FFFFh are segmented into 64 4-Kbyte ranges. Eight MTRRs are used to characterize this address space.

Table 7-6 shows the address ranges corresponding to the type fields within each fixed-range MTRR. The gray-shaded heading boxes represent the bit ranges for each type field in a fixed-range MTRR. See Table 7-5 on page 184 for the type-field encodings.

Table 7-6. Fixed-Range MTRR Address Ranges

Physical Address Range (in hexadecimal)								Register Name
63–56	55–48	47–40	39–32	31–24	23–16	15–8	7–0	
7000–7FFFF	6000–6FFFF	50000–5FFFF	40000–4FFFF	30000–3FFFF	20000–2FFFF	10000–1FFFF	00000–0FFFF	MTRRfix64K_00000
9C000–9FFFF	98000–9BFFF	94000–97FFF	90000–93FFF	8C000–8FFFF	88000–8BFFF	84000–87FFF	80000–83FFF	MTRRfix16K_80000
BC000–BFFFF	B8000–BBFFF	B4000–B7FFF	B0000–B3FFF	AC000–AFFFF	A8000–ABFFF	A4000–A7FFF	A0000–A3FFF	MTRRfix16K_A0000
C7000–C7FFF	C6000–C6FFF	C5000–C5FFF	C4000–C4FFF	C3000–C3FFF	C2000–C2FFF	C1000–C1FFF	C0000–C0FFF	MTRRfix4K_C0000
CF000–CFFFF	CE000–CEFFF	CD000–CDFFF	CC000–CCFFF	CB000–CBFFF	CA000–CAFFF	C9000–C9FFF	C8000–C8FFF	MTRRfix4K_C8000
D7000–D7FFF	D6000–D6FFF	D5000–D5FFF	D4000–D4FFF	D3000–D3FFF	D2000–D2FFF	D1000–D1FFF	D0000–D0FFF	MTRRfix4K_D0000
DF000–DFFFF	DE000–DEFFF	DD000–DDFFF	DC000–DCFFF	DB000–DBFFF	DA000–DAFFF	D9000–D9FFF	D8000–D8FFF	MTRRfix4K_D8000
E7000–E7FFF	E6000–E6FFF	E5000–E5FFF	E4000–E4FFF	E3000–E3FFF	E2000–E2FFF	E1000–E1FFF	E0000–E0FFF	MTRRfix4K_E0000

Table 7-6. Fixed-Range MTRR Address Ranges (continued)

Physical Address Range (in hexadecimal)								Register Name
63–56	55–48	47–40	39–32	31–24	23–16	15–8	7–0	
EF000– EFFFF	EE000– EEFFF	ED000– EDFFF	EC000– ECFFF	EB000– EBFFF	EA000– EAFFF	E9000– E9FFF	E8000– E8FFF	MTRRfix4K_E8000
F7000– F7FFF	F6000– F6FFF	F5000– F5FFF	F4000– F4FFF	F3000– F3FFF	F2000– F2FFF	F1000– F1FFF	F0000– F0FFF	MTRRfix4K_F0000
FF000– FFFFFF	FE000– FEFFF	FD000– FDFFF	FC000– FCFFF	FB000– FBFFF	FA000– FAFFF	F9000– F9FFF	F8000– F8FFF	MTRRfix4K_F8000

Variable-Range MTRRs. The variable-range MTRRs can be used to characterize any address range within the physical-memory space, including all of physical memory. Up to eight address ranges of varying sizes can be characterized using the MTRR. Two variable-range MTRRs are used to characterize each address range: *MTRRphysBasen* and *MTRRphysMaskn* (*n* is the address-range number from 0 to 7). For example, address-range 3 is characterized using the *MTRRphysBase3* and *MTRRphysMask3* register pair.

Figure 7-6 shows the format of the *MTRRphysBasen* register and Figure 7-7 on page 188 shows the format of the *MTRRphysMaskn* register. The fields within the register pair are read/write.

MTRRphysBasen Registers. The fields in these variable-range MTRRs, shown in Figure 7-6, are:

- *Type*—Bits 7–0. The memory type used to characterize the memory range. See Table 7-5 on page 184 for the type-field encodings. Variable-range MTRRs do not support the extended type-field encodings.
- *Range Physical Base-Address (PhysBase)*—Bits 51–12. The memory-range base-address in physical-address space. *PhysBase* is aligned on a 4-Kbyte (or greater) address in the 52-bit physical-address space supported by the AMD64 architecture. *PhysBase* represents the most-significant 40-address bits of the physical address. Physical-address bits 11–0 are assumed to be 0.

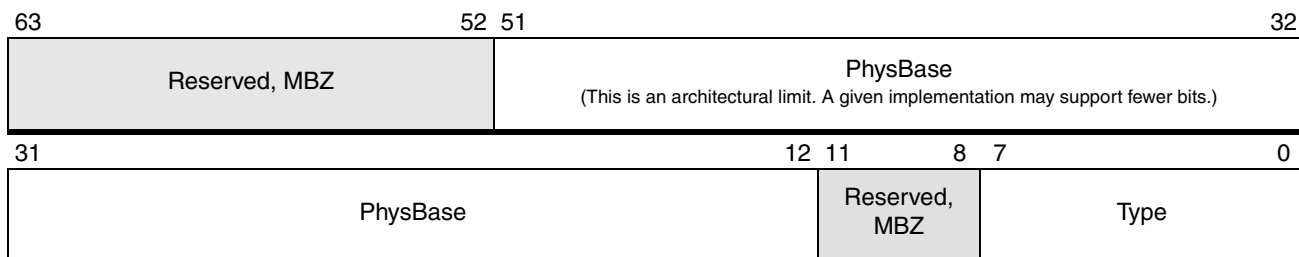

Bits	Mnemonic	Description	R/W
63-52	Reserved	Reserved, Must be Zero	
51-12	PhysBase	Range Physical Base Address	R/W
11-8	Reserved	Reserved, Must be Zero	
7-0	Type	Default Memory Type	R/W

Figure 7-6. MTRRphysBasen Register

MTRRphysMaskn Registers. The fields in these variable-range MTRRs, shown in Figure 7-7, are:

- *Valid (V)*—Bit 11. Indicates that the MTRR pair is valid (enabled) when set to 1. When the valid bit is cleared to 0 the register pair is not used.
- *Range Physical Mask (PhysMask)*—Bits 51–12. The mask value used to specify the memory range. Like PhysBase, PhysMask is aligned on a 4-Kbyte physical-address boundary. Bits 11–0 of PhysMask are assumed to be 0.

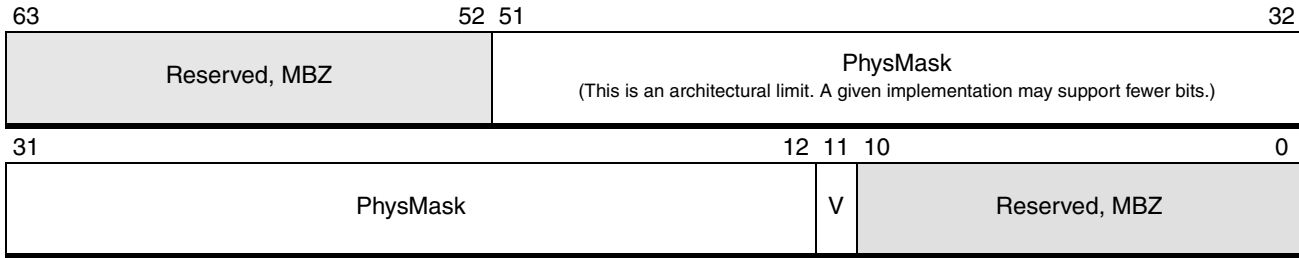

Bits	Mnemonic	Description	R/W
63-52	Reserved	Reserved, Must be Zero	
51-12	PhysMask	Range Physical Mask	R/W
11	V	MTRR Pair Enable (Valid)	R/W
10-0	Reserved	Reserved, Must be Zero	

Figure 7-7. MTRRphysMaskn Register

PhysMask and PhysBase are used together to determine whether a target physical-address falls within the specified address range. PhysMask is logically ANDed with PhysBase and separately ANDed with the upper 40 bits of the target physical-address. If the results of the two operations are identical, the target physical-address falls within the specified memory range. The pseudo-code for the operation is:

```
MaskBase = PhysMask AND PhysBase
MaskTarget = PhysMask AND Target_Address[51:12]
if MaskBase = MaskTarget
    then Target_Address_In_Range
    else Target_Address_Not_In_Range
```

Variable Range Size and Alignment. The size and alignment of variable memory-ranges (MTRRs) and I/O ranges (IORRs) are restricted as follows:

- The boundary on which a variable range is aligned must be equal to the range size. For example, a memory range of 16 Mbytes must be aligned on a 16-Mbyte boundary.
- The range size must be a power of 2 (2^n , $52 > n > 11$), with a minimum allowable size of 4 Kbytes. For example, 4 Mbytes and 8 Mbytes are allowable memory range sizes, but 6 Mbytes is not allowable.

PhysMask and PhysBase Values. Software can calculate the PhysMask value using the following procedure:

1. Subtract the memory-range physical base-address from the upper physical-address of the memory range.
2. Subtract the value calculated in Step 1 from the physical memory size.
3. Truncate the lower 12 bits of the result in Step 2 to create the PhysMask value to be loaded into the MTRRphysMask n register. Truncation is performed by right-shifting the value 12 bits.

For example, assume a 32-Mbyte memory range is specified within the 52-bit physical address space, starting at address 200_0000h. The upper address of the range is 3FF_FFFFh. Following the process outlined above yields:

1. 3FF_FFFFh–200_0000h = 1FF_FFFFh
2. F_FFFF_FFFF_FFFF–1FF_FFFFh = F_FFFF_FE00_0000h
3. Right shift (F_FFFF_FE00_0000h) by 12 = FF_FFFF_E000h

In this example, the 40-bit value loaded into the PhysMask field is FF_FFFF_E000h.

Software must also truncate the lower 12 bits of the physical base-address before loading it into the PhysBase field. In the example above, the 40-bit PhysBase field is 00_0000_2000h.

Default-Range MTRRs. Physical addresses that are not within ranges established by fixed-range and variable-range MTRRs are set to a default memory-type using the MTRRdefType register. The format of this register is shown in Figure 7-8.

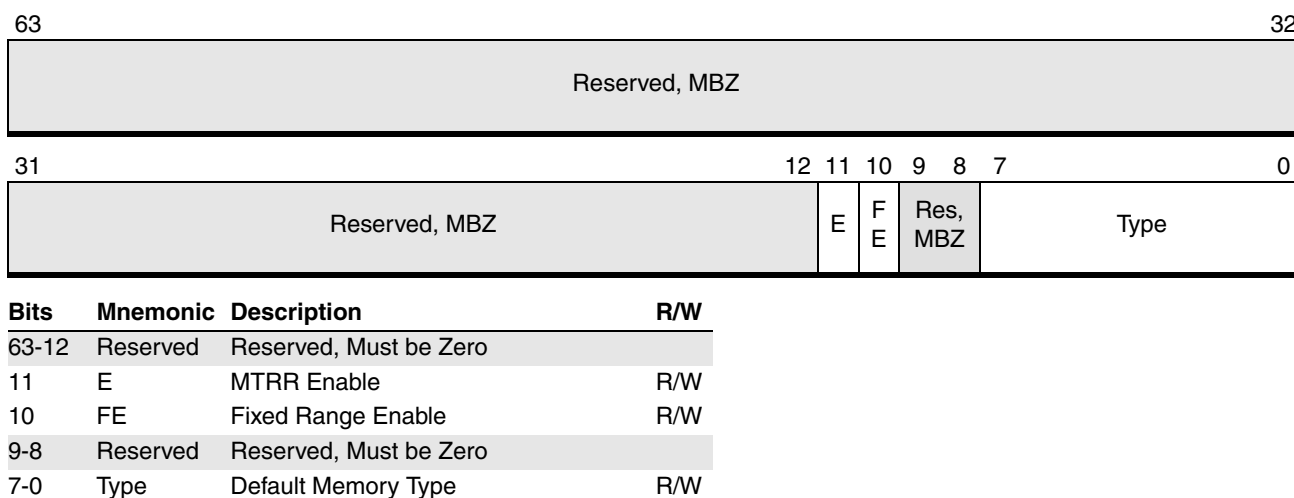

Figure 7-8. MTRR defType Register Format

The fields within the MTRRdefType register are read/write. These fields are:

- *Type*—Bits 7–0. The default memory-type used to characterize physical-memory space. See Table 7-5 on page 184 for the type-field encodings. The extended type-field encodings are not supported by this register.
- *Fixed-Range Enable (FE)*—Bit 10. All fixed-range MTRRs are enabled when FE is set to 1. Clearing FE to 0 disables all fixed-range MTRRs. Setting and clearing FE has no effect on the variable-range MTRRs. The FE bit has no effect unless the E bit is set to 1 (see below).
- *MTRR Enable (E)*—Bit 11. This is the MTRR enable bit. All fixed-range and variable-range MTRRs are enabled when E is set to 1. Clearing E to 0 disables all fixed-range and variable-range MTRRs and sets the default memory-type to uncacheable (UC) regardless of the value of the Type field.

7.7.3 Using MTRRs

Identifying MTRR Features. Software determines whether a processor supports the MTRR mechanism by executing the CPUID instruction with either function 1 or function 8000_0001h. If MTRRs are supported, bit 12 in the EDX register is set to 1 by CPUID. See “Processor Feature Identification” on page 61 for more information on the CPUID instruction.

The MTRR capability register (MTRRcap) is a read-only register containing information describing the level of MTRR support provided by the processor. Figure 7-9 shows the format of this register. If MTRRs are supported, software can read MTRRcap using the RDMSR instruction. Attempting to write to the MTRRcap register causes a general-protection exception (#GP).

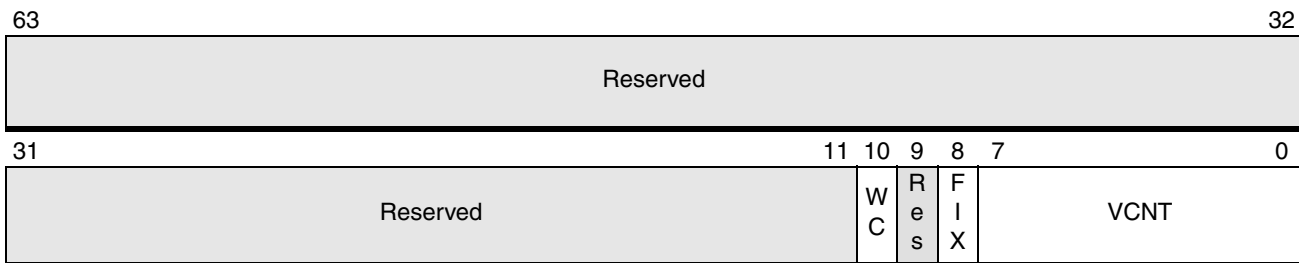

Bits	Mnemonic	Description	R/W
63-11	Reserved	Reserved	
10	WC	Write Combining	R
9	Reserved	Reserved	
8	FIX	Fixed-Range Registers	R
7-0	VCNT	Variable-Range Register Count	R

Figure 7-9. MTRR Capability Register Format

The MTRRcap register field are:

- *Variable-Range Register Count (VCNT)*—Bits 7–0. The VCNT field contains the number of variable-range register pairs supported by the processor. For example, a processor supporting eight register pairs returns a 08h in this field.
- *Fixed-Range Registers (FIX)*—Bit 8. The FIX bit indicates whether or not the fixed-range registers are supported. If the processor returns a 1 in this bit, *all* fixed-range registers are supported. If the processor returns a 0 in this bit, *no* fixed-range registers are supported.
- *Write-Combining (WC)*—Bit 10. The WC bit indicates whether or not the write-combining memory type is supported. If the processor returns a 1 in this bit, WC memory is supported, otherwise it is not supported.

7.7.4 MTRRs and Page Cache Controls

When paging and the MTRRs are both enabled, the address ranges defined by the MTRR registers can span multiple pages, each of which can characterize memory with different types (using the PCD and PWT page bits). When caching is enabled (CR0.CD=0 and CR0.NW=0), the *effective memory-type* is determined as follows:

1. If the page is defined as cacheable and writeback (PCD=0 and PWT=0), then the MTRR defines the effective memory-type.
2. If the page is defined as not cacheable (PCD=1), then UC is the effective memory-type.
3. If the page is defined as cacheable and writethrough (PCD=0 and PWT=1), then the MTRR defines the effective memory-type *unless* the MTRR specifies WB memory, in which case WT is the effective memory-type.

Table 7-7 lists the MTRR and page-level cache-control combinations and their combined effect on the final memory-type, if the PAT register holds the default settings.

Table 7-7. Combined MTRR and Page-Level Memory Type with Unmodified PAT MSR

MTRR Memory Type	Page PCD Bit	Page PWT Bit	Effective Memory-Type
UC	—	—	UC
WC	0	—	WC
	1	0	WC ¹
	1	1	UC
WP	0	—	WP
	1	—	UC

Note:
1. The effective memory-type resulting from the combination of PCD=1, PWT=0, and an MTRR WC memory type is implementation dependent.

Table 7-7. Combined MTRR and Page-Level Memory Type with Unmodified PAT MSR (continued)

MTRR Memory Type	Page PCD Bit	Page PWT Bit	Effective Memory-Type
WT	0	—	WT
	1	—	UC
WB	0	0	WB
	0	1	WT
	1	—	UC
Note:			
1. The effective memory-type resulting from the combination of PCD=1, PWT=0, and an MTRR WC memory type is implementation dependent.			

Large Page Sizes. When paging is enabled, software can use large page sizes (2 Mbytes and 4 Mbytes) in addition to the more typical 4-Kbyte page size. When large page sizes are used, it is possible for multiple MTRRs to span the memory range within a single large page. Each MTRR can characterize the regions within the page with different memory types. If this occurs, the effective memory-type used by the processor within the large page is undefined.

Software can avoid the undefined behavior in one of the following ways:

- Avoid using multiple MTRRs to characterize a single large page.
- Use multiple 4-Kbyte pages rather than a single large page.
- If multiple MTRRs must be used within a single large page, software can set the MTRR type fields to the same value.
- If the multiple MTRRs must have different type-field values, software can set the large page PCD and PWT bits to the most restrictive memory type defined by the multiple MTRRs.

Overlapping MTRR Registers. If the address ranges of two or more MTRRs overlap, the following rules are applied to determine the memory type used to characterize the overlapping address range:

1. Fixed-range MTRRs, which characterize only the first 1 Mbyte of physical memory, have precedence over variable-range MTRRs.
2. If two or more variable-range MTRRs overlap, the following rules apply:
 - a. If the memory types are identical, then that memory type is used.
 - b. If at least one of the memory types is UC, the UC memory type is used.
 - c. If at least one of the memory types is WT, and the only other memory type is WB, then the WT memory type is used.
 - d. If the combination of memory types is not listed Steps A through C immediately above, then the memory type used is undefined.

7.7.5 MTRRs in Multi-Processing Environments

In multi-processing environments, the MTRRs located in all processors must characterize memory in the same way. Generally, this means that identical values are written to the MTRRs used by the processors. This also means that values CR0.CD and the PAT must be consistent across processors. Failure to do so may result in coherency violations or loss of atomicity. Processor implementations *do not* check the MTRR settings in other processors to ensure consistency. It is the responsibility of system software to initialize and maintain MTRR consistency across all processors.

7.8 Page-Attribute Table Mechanism

The page-attribute table (PAT) mechanism extends the page-table entry format and enhances the capabilities provided by the PCD and PWT page-level cache controls. PAT (and PCD, PWT) allow memory-type characterization based on the virtual (linear) address. The PAT mechanism provides the same memory-typing capabilities as the MTRRs but with the added flexibility of the paging mechanism. Software can use both the PAT and MTRR mechanisms to maximize flexibility in memory-type control.

7.8.1 PAT Register

Like the MTRRs, the PAT register is a 64-bit model-specific register (MSR). The format of the PAT registers is shown in Figure 7-10. See “Memory-Typing MSRs” on page 464 for more information on the PAT MSR number and reset value.

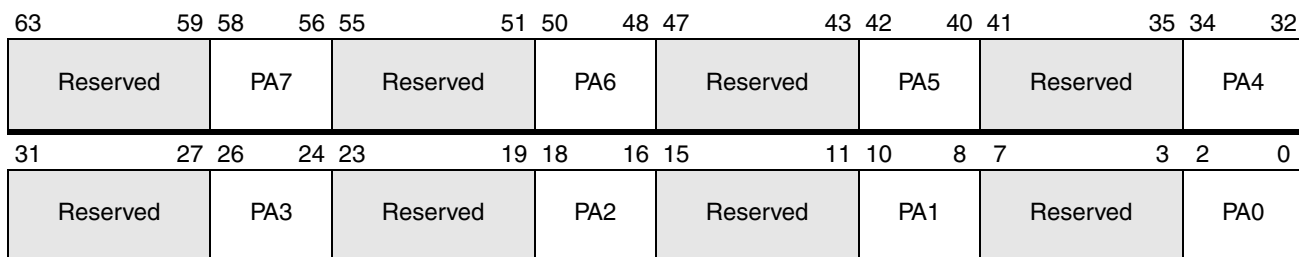

Figure 7-10. PAT Register

The PAT register contains eight page-attribute (PA) fields, numbered from PA0 to PA7. The PA fields hold the encoding of a memory type, as found in Table 7-8 on page 194. The PAT type-encodings match the MTRR type-encodings, with the exception that PAT adds the 07h encoding. The 07h encoding corresponds to a UC- type. The UC- type (07h) is identical to the UC type (00h) except it can be overridden by an MTRR type of WC.

Software can write any supported memory-type encoding into any of the eight PA fields. An attempt to write anything but zeros into the reserved fields causes a general-protection exception (#GP). An attempt to write an unsupported type encoding into a PA field also causes a #GP exception.

The PAT register fields are initiated at processor reset to the default values shown in Table 7-9 on page 195.

Table 7-8. PAT Type Encodings

Type Value	Type Name	Type Description
00h	UC—Uncacheable	All accesses are uncacheable. Write combining is not allowed. Speculative accesses are not allowed.
01h	WC—Write-Combining	All accesses are uncacheable. Write combining is allowed. Speculative reads are allowed.
04h	WT—Writethrough	Reads allocate cache lines on a cache miss, but only to the shared state. Cache lines are not allocated on a write miss. Write hits update the cache and main memory.
05h	WP—Write-Protect	Reads allocate cache lines on a cache miss, but only to the shared state. All writes update main memory. Cache lines are not allocated on a write miss. Write hits invalidate the cache line and update main memory.
06h	WB—Writeback	Reads allocate cache lines on a cache miss, and can allocate to either the shared or exclusive state. Writes allocate to the modified state on a cache miss.
07h	UC— (UC minus)	All accesses are uncacheable. Write combining is not allowed. Speculative accesses are not allowed. Can be overridden by an MTRR with the WC type.

7.8.2 PAT Indexing

PA fields in the PAT register are selected using three bits from the page-table entries. These bits are:

- *PAT (page attribute table)*—The PAT bit is bit 7 in 4-Kbyte PTEs; it is bit 12 in 2-Mbyte and 4-Mbyte PDEs. Page-table entries that don't have a PAT bit (PML4 entries, for example) assume PAT = 0.
- *PCD (page cache disable)*—The PCD bit is bit 4 in all page-table entries. The PCD from the PTE or PDE is selected depending on the paging mode.
- *PWT (page writethrough)*—The PWT bit is bit 3 in all page-table entries. The PWT from the PTE or PDE is selected depending on the paging mode.

Table 7-9 on page 195 shows the various combinations of the PAT, PCD, and PWT bits used to select a PA field within the PAT register. Table 7-9 also shows the default memory-type values established in the PAT register by the processor after a reset. The default values correspond to the memory types established by the PCD and PWT bits alone in processor implementations that do not support the PAT mechanism. In such implementations, the PAT field in page-table entries is reserved and cleared to 0. See “Page-Translation-Table Entry Fields” on page 135 for more information on the page-table entries.

Table 7-9. PAT-Register PA-Field Indexing

Page-Table Entry Bits			PAT Register Field	Default Memory Type
PAT	PCD	PWT		
0	0	0	PA0	WB
0	0	1	PA1	WT
0	1	0	PA2	UC ⁻¹
0	1	1	PA3	UC
1	0	0	PA4	WB
1	0	1	PA5	WT
1	1	0	PA6	UC ⁻¹
1	1	1	PA7	UC

Note:
1. Can be overridden by WC memory type set by an MTRR.

7.8.3 Identifying PAT Support

Software determines whether a processor supports the PAT mechanism by executing the CPUID instruction with either function 1 or function 8000_0001h. If PAT is supported, bit 16 in the EDX register is set to 1 by CPUID. See “Processor Feature Identification” on page 61 for more information on the CPUID instruction.

If PAT is supported by a processor implementation, it is *always enabled*. The PAT mechanism cannot be disabled by software. Software can effectively avoid using PAT by:

- Not setting PAT bits in page-table entries to 1.
- Not modifying the reset values of the PA fields in the PAT register.

In this case, memory is characterized using the same types that are used by implementations that do not support PAT.

7.8.4 PAT Accesses

In implementations that support the PAT mechanism, all memory accesses that are translated through the paging mechanism use the PAT index bits to specify a PA field in the PAT register. The memory type stored in the specified PA field is applied to the memory access. The process is summarized as:

1. A virtual address is calculated as a result of a memory access.
2. The virtual address is translated to a physical address using the page-translation mechanism.
3. The PAT, PCD and PWT bits are read from the corresponding page-table entry during the virtual-address to physical-address translation.
4. The PAT, PCD and PWT bits are used to select a PA field from the PAT register.
5. The memory type is read from the appropriate PA field.
6. The memory type is applied to the physical-memory access using the translated physical address.

Page-Translation Table Access. The PAT bit exists only in the PTE (4-K paging) or PDEs (2/4 Mbyte paging). In the remaining upper levels (PML4 PDP, 4K PDEs), only the PWT and PCD bits are used to index into the first 4 entries in the PAT register. The resulting memory type is used for the next lower paging level.

7.8.5 Combined Effect of MTRRs and PAT

The memory types established by the PAT mechanism can be combined with MTRR-established memory types to form an effective memory-type. The combined effect of MTRR and PAT memory types are shown in Figure 7-10. In the AMD64 architecture, reserved and undefined combinations of MTRR and PAT memory types result in undefined behavior. If the MTRRs are disabled in implementations that support the MTRR mechanism, the default memory type is set to uncacheable (UC).

Table 7-10. Combined Effect of MTRR and PAT Memory Types

PAT Memory Type	MTRR Memory Type	Effective Memory Type
UC	UC, WC, WP, WT, WB	UC
UC-	UC	UC
	WC	WC
	WP, WT, WB	UC ¹
WC	—	WC
WP	UC	UC
	WC	UC ¹
	WP	WP
	WT	UC ¹
	WB	WP
WT	UC	UC
	WC, WP	UC ¹
	WT, WB	WT
WB	UC	UC
	WC	WC
	WP	WP
	WT	WT
	WB	WB
Note:		
1. Previously reserved (undefined) combinations are set to the UC memory type by the AMD64 architecture.		

7.8.6 PATs in Multi-Processing Environments

In multi-processing environments, values of CR0.CD and the PAT must be consistent across all processors and the MTRRs located in all processors must characterize memory in the same way (identical values are written to the MTRRs used by the processors). Failure to do so may result in coherency violations or loss of atomicity. Processor implementations *do not* check the MTRR, CR0.CD and PAT values in other processors to ensure consistency. It is the responsibility of system software to initialize and maintain consistency across all processors.

7.9 Memory-Mapped I/O

Processor implementations can independently direct reads and writes to either system memory or memory-mapped I/O. The method used for directing those memory accesses is implementation dependent. In some implementations, separate system-memory and memory-mapped I/O buses can be provided at the processor interface. In other implementations, system memory and memory-mapped I/O share common data and address buses, and system logic uses sideband signals from the processor to route accesses appropriately. Refer to AMD data sheets and application notes for more information about particular hardware implementations of the AMD64 architecture.

The I/O range registers (IORRs), and the top-of-memory registers allow system software to specify where memory accesses are directed for a given address range. The MTRR extensions are described in the following section. “IORRs” on page 199 describes the IORRs and “Top of Memory” on page 201 describes the top-of-memory registers. *In implementations that support these features, the default action taken when the features are disabled is to direct memory accesses to memory-mapped I/O.*

7.9.1 Extended Fixed-Range MTRR Type-Field Encodings

The fixed-range MTRRs support extensions to the type-field encodings that allow system software to direct memory accesses to system memory or memory-mapped I/O. The extended MTRR type-field encodings use previously reserved bits 4–3 to specify whether reads and writes to a physical-address range are to system memory or to memory-mapped I/O. The format for this encoding is shown in Figure 7-11 on page 198. The new bits are:

- *WrMem*—Bit 3. When set to 1, the processor directs write requests for this physical address range to system memory. When cleared to 0, writes are directed to memory-mapped I/O.
- *RdMem*—Bit 4. When set to 1, the processor directs read requests for this physical address range to system memory. When cleared to 0, reads are directed to memory-mapped I/O.

The type subfield (bits 2–0) allows the encodings specified in Table 7-5 on page 184 to be used for memory characterization.

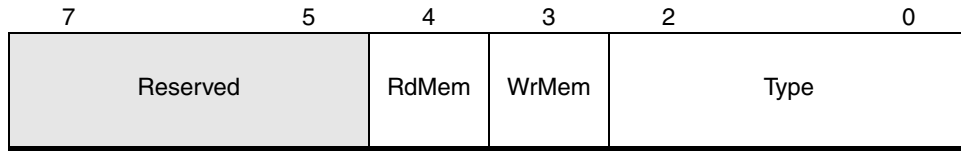

Figure 7-11. Extended MTRR Type-Field Format (Fixed-Range MTRRs)

These extensions are enabled using the following bits in the SYSCFG MSR:

- *MtrrFixDramEn*—Bit 18. When set to 1, RdMem and WrMem attributes are enabled. When cleared to 0, these attributes are disabled. *When disabled, accesses are directed to memory-mapped I/O space.*
- *MtrrFixDramModEn*—Bit 19. When set to 1, software can read and write the RdMem and WrMem bits. When cleared to 0, writes do not modify the RdMem and WrMem bits, and reads return 0.

To use the MTRR extensions, system software must first set *MtrrFixDramModEn*=1 to allow modification to the RdMem and WrMem bits. After the attribute bits are properly initialized in the fixed-range registers, the extensions can be enabled by setting *MtrrFixDramEn*=1.

RdMem and WrMem allow the processor to independently direct reads and writes to either system memory or memory-mapped I/O. The RdMem and WrMem controls are particularly useful when shadowing ROM devices located in memory-mapped I/O space. It is often useful to shadow such devices in RAM system memory to improve access performance, but writes into the RAM location can corrupt the shadowed ROM information. The MTRR extensions solve this problem. System software can create the shadow location by setting *WrMem* = 1 and *RdMem* = 0 for the specified memory range and then copy the ROM location into itself. Reads are directed to the memory-mapped ROM, but writes go to the same physical addresses in system memory. After the copy is complete, system software can change the bit values to *WrMem* = 0 and *RdMem* = 1. Now reads are directed to the faster copy located in system memory, and writes are directed to memory-mapped ROM. The ROM responds as it would normally to a write, which is to ignore it.

Not all combinations of RdMem and WrMem are supported for each memory type encoded by bits 2–0. Table 7-11 on page 199 shows the allowable combinations. The behavior of reserved encoding combinations (shown as gray-shaded cells) is undefined and results in unpredictable behavior.

Table 7-11. Extended Fixed-Range MTRR Type Encodings

RdMem	WrMem	Type	Implication or Potential Use
0	0	0 (UC)	UC I/O
		1 (WC)	WC I/O
		4 (WT)	WT I/O
		5 (WP)	WP I/O
		6 (WB)	Reserved
0	1	0 (UC)	Used while creating a shadowed ROM
		1 (WC)	
		4 (WT)	Reserved
		5 (WP)	
		6 (WB)	
1	0	0 (UC)	Used to access a shadowed ROM
		1 (WC)	Reserved
		4 (WT)	
		5 (WP)	WP Memory (Can be used to access shadowed ROM)
		6 (WB)	Reserved
1	1	0 (UC)	UC Memory
		1 (WC)	WC Memory
		4 (WT)	WT Memory
		5 (WP)	Reserved
		6 (WB)	WB Memory

7.9.2 IORRs

The IORRs operate similarly to the variable-range MTRRs. The IORRs specify whether reads and writes in any physical-address range map to system memory or memory-mapped I/O. Up to two address ranges of varying sizes can be controlled using the IORRs. A pair of IORRs are used to control each address range: $IORRBase_n$ and $IORRMask_n$ (n is the address-range number from 0 to 1).

Figure 7-12 on page 200 shows the format of the $IORRBase_n$ registers and Figure 7-13 on page 201 shows the format of the $IORRMask_n$ registers. The fields within the register pair are read/write.

The intersection of the IORR range with the equivalent effective MTRR range follows the same type encoding table (Table 7-11) as the fixed-range MTRR, where the RdMem/WrMem and memory type are directly tied together.

IORRBase_n Registers. The fields in these IORRs are:

- *WrMem*—Bit 3. When set to 1, the processor directs write requests for this physical address range to system memory. When cleared to 0, writes are directed to memory-mapped I/O.

- *RdMem*—Bit 4. When set to 1, the processor directs read requests for this physical address range to system memory. When cleared to 0, reads are directed to memory-mapped I/O.
- *Range Physical-Base-Address (PhysBase)*—Bits 51–12. The memory-range base-address in physical-address space. PhysBase is aligned on a 4-Kbyte (or greater) address in the 52-bit physical-address space supported by the AMD64 architecture. PhysBase represents the most-significant 40-address bits of the physical address. Physical-address bits 11–0 are assumed to be 0.

The format of these registers is shown in Figure 7-12.

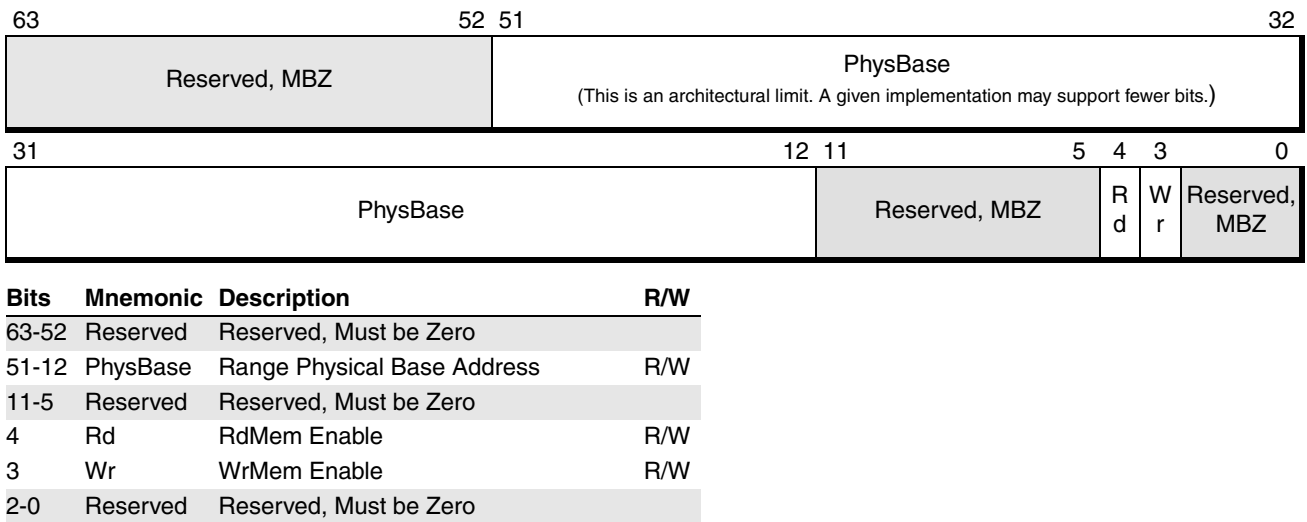
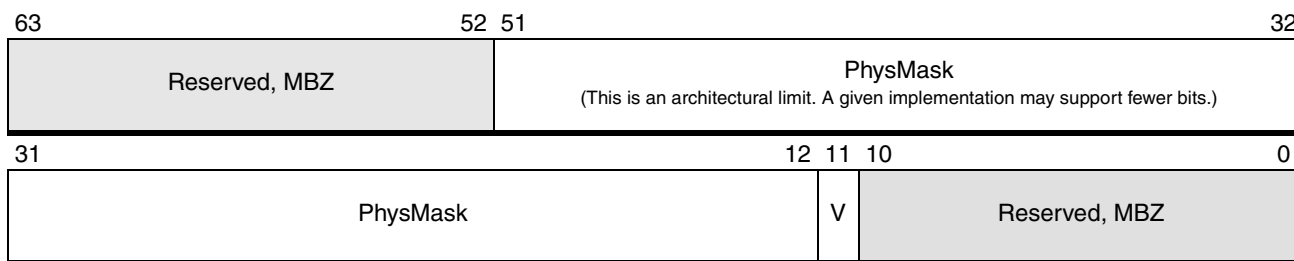

Figure 7-12. IORRBase_n Register

IORRMask_n Registers. The fields in these IORRs are:

- *Valid (V)*—Bit 11. Indicates that the IORR pair is valid (enabled) when set to 1. When the valid bit is cleared to 0 the register pair is not used for memory-mapped I/O control (disabled).
- *Range Physical-Mask (PhysMask)*—Bits 51–12. The mask value used to specify the memory range. Like PhysBase, PhysMask is aligned on a 4-Kbyte physical-address boundary. Bits 11–0 of PhysMask are assumed to be 0.

The format of these registers is shown in Figure 7-13 on page 201.



Bits	Mnemonic	Description	R/W
63-52	Reserved	Reserved, Must be Zero	
51-12	PhysMask	Range Physical Mask	R/W
11	V	I/O Register Pair Enable (Valid)	R/W
10-0	Reserved	Reserved, Must be Zero	

Figure 7-13. IORRMaskn Register

The operation of the PhysMask and PhysBase fields is identical to that of the variable-range MTRRs. See page 188 for a description of this operation.

7.9.3 IORR Overlapping

The use of overlapping IORRs is not recommended. If overlapping IORRs are specified, the resulting behavior is implementation-dependent.

7.9.4 Top of Memory

The *top-of-memory* registers, TOP_MEM and TOP_MEM2, allow system software to specify physical addresses ranges as memory-mapped I/O locations. Processor implementations can direct accesses to memory-mapped I/O differently than system I/O, and the precise method depends on the implementation. System software specifies memory-mapped I/O regions by writing an address into each of the top-of-memory registers. The memory regions specified by the TOP_MEM registers are aligned on 8-Mbyte boundaries as follows:

- Memory accesses from physical address 0 to one less than the value in TOP_MEM are directed to system memory.
- Memory accesses from the physical address specified in TOP_MEM to FFFF_FFFFh are directed to memory-mapped I/O.
- Memory accesses from physical address 1_0000_0000h to one less than the value in TOP_MEM2 are directed to system memory.
- Memory accesses from the physical address specified in TOP_MEM2 to the maximum physical address supported by the system are directed to memory-mapped I/O.

Figure 7-14 on page 202 shows how the top-of-memory registers organize memory into separate system-memory and memory-mapped I/O regions.

The intersection of the top-of-memory range with the equivalent effective MTRR range follows the same type encoding table (Table 7-11 on page 199) as the fixed-range MTRR, where the RdMem/WrMem and memory type are directly tied together.

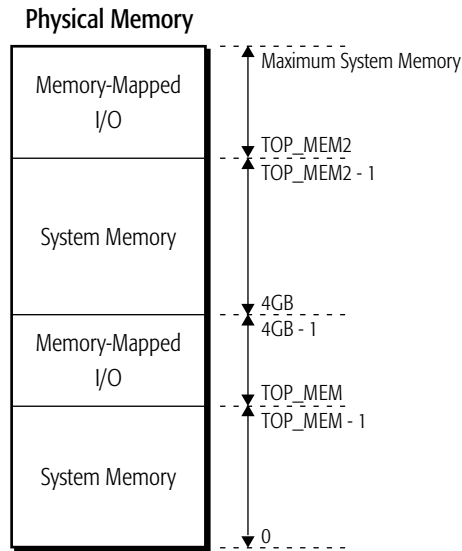

513-269.eps

Figure 7-14. Memory Organization Using Top-of-Memory Registers

Figure 7-15 shows the format of the TOP_MEM and TOP_MEM2 registers. Bits 51–23 specify an 8-Mbyte aligned physical address. All remaining bits are reserved and ignored by the processor. System software should clear those bits to zero to maintain compatibility with possible future extensions to the registers. The TOP_MEM registers are model-specific registers. See “Memory-Typing MSRs” on page 464 for information on the MSR address and reset values for these registers.

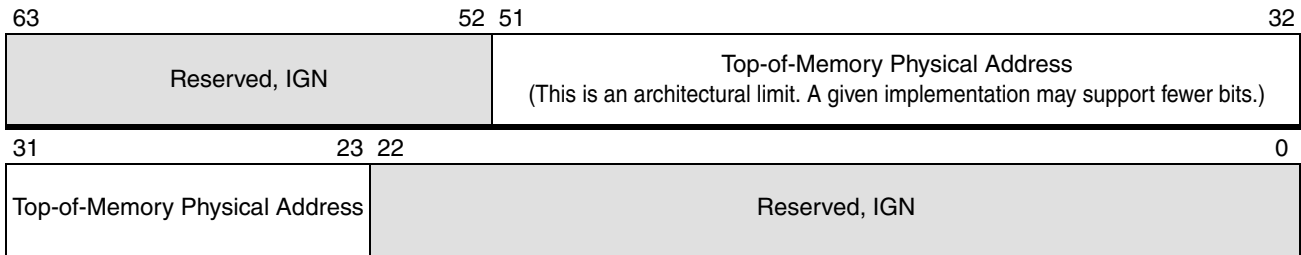

Figure 7-15. Top-of-Memory Registers (TOP_MEM, TOP_MEM2)

The TOP_MEM register is enabled by setting the MtrrVarDramEn bit in the SYSCFG MSR (bit 20) to 1. The TOP_MEM2 register is enabled by setting the MtrrTom2En bit in the SYSCFG MSR (bit 21) to 1. The registers are disabled when their respective enable bits are cleared to 0. When the top-of-memory registers are disabled, memory accesses default to memory-mapped I/O space.

8 Exceptions and Interrupts

Exceptions and interrupts force control transfers from the currently-executing program to a system-software service routine that handles the interrupting event. These routines are referred to as *exception handlers* and *interrupt handlers*, or collectively as *event handlers*. Typically, interrupt events can be handled by the service routine transparently to the interrupted program. During the control transfer to the service routine, the processor stops executing the interrupted program and saves its return pointer. The system-software service routine that handles the exception or interrupt is responsible for saving the state of the interrupted program. This allows the processor to restart the interrupted program after system software has handled the event.

When an exception or interrupt occurs, the processor uses the interrupt-vector number as an index into the interrupt-descriptor table (IDT). An IDT is used in all processor operating modes, including real mode (also called real-address mode), protected mode, and long mode.

Exceptions and interrupts come from three general sources:

- *Exceptions* occur as a result of software execution errors or other internal-processor errors. Exceptions also occur during non-error situations, such as program single stepping or address-breakpoint detection. Exceptions are considered *synchronous* events because they are a direct result of executing the interrupted instruction.
- *Software interrupts* occur as a result of executing interrupt instructions. Unlike exceptions and external interrupts, software interrupts allow intentional triggering of the interrupt-handling mechanism. Like exceptions, software interrupts are synchronous events.
- *External interrupts* are generated by system logic in response to an error or some other event outside the processor. They are reported over the processor bus using external signalling. External interrupts are *asynchronous* events that occur independently of the interrupted instruction.

Throughout this section, the term *masking* can refer to either disabling or delaying an interrupt. For example, masking external interrupts *delays* the interrupt, with the processor holding the interrupt as pending until it is unmasked. With floating-point exceptions (128-bit media and x87), masking *prevents* an interrupt from occurring and causes the processor to perform a default operation on the exception condition.

8.1 General Characteristics

Exceptions and interrupts have several different characteristics that depend on how events are reported and the implications for program restart.

8.1.1 Precision

Precision describes how the exception is related to the interrupted program:

- *Precise* exceptions are reported on a predictable instruction boundary. This boundary is generally the first instruction that has not completed when the event occurs. All previous instructions (in

program order) are allowed to complete before transferring control to the event handler. The pointer to the instruction boundary is saved automatically by the processor. When the event handler completes execution, it returns to the interrupted program and restarts execution at the interrupted-instruction boundary.

- *Imprecise* exceptions are not guaranteed to be reported on a predictable instruction boundary. The boundary can be any instruction that has not completed when the interrupt event occurs. Imprecise events can be considered asynchronous, because the source of the interrupt is not necessarily related to the interrupted instruction. Imprecise exception and interrupt handlers typically collect machine-state information related to the interrupting event for reporting through system-diagnostic software. The interrupted program is not restartable.

8.1.2 Instruction Restart

As mentioned above, precise exceptions are reported on an instruction boundary. The instruction boundary can be reported in one of two locations:

- Most exceptions report the boundary *before* the instruction causing the exception. In this case, all previous instructions (in program order) are allowed to complete, but the interrupted instruction is not. *No program state is updated as a result of partially executing an interrupted instruction.*
- Some exceptions report the boundary *after* the instruction causing the exception. In this case, all previous instructions—including the one executing when the exception occurred—are allowed to complete.

Program state can be updated when the reported boundary is after the instruction causing the exception. This is particularly true when the event occurs as a result of a task switch. In this case, the general registers, segment-selector registers, page-base address register, and LDTR are all updated by the hardware task-switch mechanism. The event handler cannot rely on the state of those registers when it begins execution and must be careful in validating the state of the segment-selector registers before restarting the interrupted task. This is not an issue in long mode, however, because the hardware task-switch mechanism is disabled in long mode.

8.1.3 Types of Exceptions

There are three types of exceptions, depending on whether they are precise and how they affect program restart:

- *Faults* are precise exceptions reported on the boundary before the instruction causing the exception. Generally, faults are caused by an error condition involving the faulted instruction. Any machine-state changes caused by the faulting instruction are discarded so that the instruction can be restarted. The saved RIP points to the faulting instruction.
- *Traps* are precise exceptions reported on the boundary following the instruction causing the exception. The trapped instruction is completed by the processor and all state changes are saved. The saved RIP points to the instruction following the faulting instruction.
- *Aborts* are imprecise exceptions. Because they are imprecise, aborts typically do not allow reliable program restart.

8.1.4 Masking External Interrupts

General Masking Capabilities. Software can *mask* the occurrence of certain exceptions and interrupts. Masking can delay or even prevent triggering of the exception-handling or interrupt-handling mechanism when an interrupt-event occurs. External interrupts are classified as maskable or nonmaskable:

- *Maskable interrupts* trigger the interrupt-handling mechanism only when RFLAGS.IF=1. Otherwise they are held pending for as long as the RFLAGS.IF bit is cleared to 0.
- *Nonmaskable interrupts* (NMI) are unaffected by the value of the rFLAGS.IF bit. However, the occurrence of an NMI masks further NMIs until an IRET instruction is executed.

Masking During Stack Switches. The processor delays recognition of maskable external interrupts and debug exceptions during certain instruction sequences that are often used by software to switch stacks. The typical programming sequence used to switch stacks is:

1. Load a stack selector into the SS register.
2. Load a stack offset into the ESP register.

If an interrupting event occurs after the selector is loaded but before the stack offset is loaded, the interrupted-program stack pointer is invalid during execution of the interrupt handler.

To prevent interrupts from causing stack-pointer problems, the processor does not allow external interrupts or debug exceptions to occur until the instruction immediately following the MOV SS or POP SS instruction completes execution.

The recommended method of performing this sequence is to use the LSS instruction. LSS loads both SS and ESP, and the instruction inhibits interrupts until both registers are updated successfully.

8.1.5 Masking Floating-Point and Media Instructions

Any x87 floating-point exceptions can be masked and reported later using bits in the x87 floating-point status register (FSW) and the x87 floating-point control register (FCW). The floating-point exception-pending exception is used for unmasked x87 floating-point exceptions (see “#MF—x87 Floating-Point Exception-Pending (Vector 16)” on page 220).

The SIMD floating-point exception is used for unmasked 128-bit media floating-point exceptions (see “#XF—SIMD Floating-Point Exception (Vector 19)” on page 223). 128-bit media floating-point exceptions are masked using the MXCSR register. The exception mechanism is not triggered when these exceptions are masked. Instead, the processor handles the exceptions in a default manner.

8.1.6 Disabling Exceptions

Disabling an exception prevents the exception condition from being recognized, unlike masking an exception which prevents triggering the exception mechanism after the exception is recognized. Some exceptions can be disabled by system software running at CPL=0, using bits in the CR0 register or CR4 register:

- Alignment-check exception (see “#AC—Alignment-Check Exception (Vector 17)” on page 221).
- Device-not-available exception (see “#NM—Device-Not-Available Exception (Vector 7)” on page 214).
- Machine-check exception (see “#MC—Machine-Check Exception (Vector 18)” on page 222).

The debug-exception mechanism provides control over when specific breakpoints are enabled and disabled. See “Breakpoints” on page 335 for more information on how breakpoint controls are used for triggering the debug-exception mechanism.

8.2 Vectors

Specific exception and interrupt sources are assigned a fixed vector-identification number (also called an “interrupt vector” or simply “vector”). The interrupt vector is used by the interrupt-handling mechanism to locate the system-software service routine assigned to the exception or interrupt. Up to 256 unique interrupt vectors are available. The first 32 vectors are reserved for predefined exception and interrupt conditions. Software-interrupt sources can trigger an interrupt using any available interrupt vector.

Table 8-1 on page 209 lists the supported interrupt-vector numbers, the corresponding exception or interrupt name, the mnemonic, the source of the interrupt event, and a summary of the possible causes.

Table 8-1. Interrupt-Vector Source and Cause

Vector	Exception/Interrupt	Mnemonic	Cause
0	Divide-by-Zero-Error	#DE	DIV, IDIV, AAM instructions
1	Debug	#DB	Instruction accesses and data accesses
2	Non-Maskable-Interrupt	#NMI	External NMI signal
3	Breakpoint	#BP	INT3 instruction
4	Overflow	#OF	INTO instruction
5	Bound-Range	#BR	BOUND instruction
6	Invalid-Opcode	#UD	Invalid instructions
7	Device-Not-Available	#NM	x87 instructions
8	Double-Fault	#DF	Exception during the handling of another exception or interrupt
9	Coprocessor-Segment-Overrun	—	Unsupported (Reserved)
10	Invalid-TSS	#TS	Task-state segment access and task switch
11	Segment-Not-Present	#NP	Segment register loads
12	Stack	#SS	SS register loads and stack references
13	General-Protection	#GP	Memory accesses and protection checks
14	Page-Fault	#PF	Memory accesses when paging enabled
15	Reserved	—	—
16	x87 Floating-Point Exception-Pending	#MF	x87 floating-point instructions
17	Alignment-Check	#AC	Misaligned memory accesses
18	Machine-Check	#MC	Model specific
19	SIMD Floating-Point	#XF	128-bit media floating-point instructions
20—29	Reserved	—	—
30	Security Exception	#SX	Security-sensitive event in host
31	Reserved	—	—
0—255	External Interrupts (Maskable)	#INTR	External interrupts
0—255	Software Interrupts	—	INT n instruction

Table 8-2 on page 210 shows how each interrupt vector is classified. Reserved interrupt vectors are indicated by the gray-shaded rows.

Table 8-2. Interrupt-Vector Classification

Vector	Interrupt (Exception)	Type	Precise	Class ²
0	Divide-by-Zero-Error	Fault	yes	Contributory
1	Debug	Fault or Trap		
2	Non-Maskable-Interrupt	—	—	Benign
3	Breakpoint	Trap	yes	
4	Overflow			
5	Bound-Range	Fault		
6	Invalid-Opcode			
7	Device-Not-Available			
8	Double-Fault	Abort	no	
9	Coprocessor-Segment-Overrun			
10	Invalid-TSS	Fault	yes	Contributory
11	Segment-Not-Present			
12	Stack			
13	General-Protection			
14	Page-Fault			Benign or Contributory
15	Reserved			
16	x87 Floating-Point Exception-Pending	Fault	no	Benign
17	Alignment-Check		yes	
18	Machine-Check	Abort	no	
19	SIMD Floating-Point	Fault	yes	
20—29	Reserved			
30	Security Exception	—	yes	Contributory
31	Reserved			
0—255	External Interrupts (Maskable)	— ¹	— ¹	Benign
0—255	Software Interrupts			

Note:

- External interrupts are not classified by type or whether or not they are precise.
- See “#DF—Double-Fault Exception (Vector 8)” on page 214 for a definition of benign and contributory classes.

The following sections describe each interrupt in detail. The format of the error code reported by each interrupt is described in “Error Codes” on page 224.

8.2.1 #DE—Divide-by-Zero-Error Exception (Vector 0)

A #DE exception occurs when the denominator of a DIV instruction or an IDIV instruction is 0. A #DE also occurs if the result is too large to be represented in the destination.

#DE cannot be disabled.

Error Code Returned. None.

Program Restart. #DE is a fault-type exception. The saved instruction pointer points to the instruction that caused the #DE.

8.2.2 #DB—Debug Exception (Vector 1)

When the debug-exception mechanism is enabled, a #DB exception can occur under any of the following circumstances:

- Instruction execution.
- Instruction single stepping.
- Data read.
- Data write.
- I/O read.
- I/O write.
- Task switch.
- Debug-register access, or *general detect fault* (debug register access when DR7.GD=1).
- Executing the INT1 instruction (opcode 0F1h).

#DB conditions are enabled and disabled using the debug-control register, DR7 and RFLAGS.TF. Each #DB condition is described in more detail in “Breakpoints” on page 335.

Error Code Returned. None. #DB information is returned in the debug-status register, DR6.

Program Restart. #DB can be either a fault-type or trap-type exception. In the following cases, the saved instruction pointer points to the instruction that caused the #DB:

- Instruction execution.
- Invalid debug-register access, or *general detect*.

In all other cases, the instruction that caused the #DB is completed, and the saved instruction pointer points to the instruction after the one that caused the #DB.

The RFLAGS.RF bit can be used to restart an instruction following an instruction breakpoint resulting in a #DB. In most cases, the processor clears RFLAGS.RF to 0 after every instruction is successfully executed. However, in the case of the IRET, JMP, CALL, and INT n (through a task gate) instructions, RFLAGS.RF is not cleared to 0 until the *next* instruction successfully executes.

When a non-debug exception occurs (or when a string instruction is interrupted), the processor normally sets RFLAGS.RF to 1 in the RFLAGS *image* that is pushed on the interrupt stack. A subsequent IRET back to the interrupted program pops the RFLAGS image off the stack and into the RFLAGS register, with RFLAGS.RF=1. The interrupted instruction executes without causing an instruction breakpoint, after which the processor clears RFLAGS.RF to 0.

However, when a #DB exception occurs, the processor clears RFLAGS.RF to 0 in the RFLAGS image that is pushed on the interrupt stack. The #DB handler has two options:

- Disable the instruction breakpoint completely.
- Set RFLAGS.RF to 1 in the interrupt-stack rFLAGS image. The instruction breakpoint condition is ignored immediately after the IRET, but reoccurs if the instruction address is accessed later, as can occur in a program loop.

8.2.3 NMI—Non-Maskable-Interrupt Exception (Vector 2)

An NMI exception occurs as a result of system logic signalling a non-maskable interrupt to the processor.

Error Code Returned. None.

Program Restart. NMI is an interrupt. The processor recognizes an NMI at an instruction boundary. The saved instruction pointer points to the instruction immediately following the boundary where the NMI was recognized.

Masking. NMI cannot be masked. However, when an NMI is recognized by the processor, recognition of subsequent NMIs are disabled until an IRET instruction is executed.

8.2.4 #BP—Breakpoint Exception (Vector 3)

A #BP exception occurs when an INT3 instruction is executed. The INT3 is normally used by debug software to set instruction breakpoints by replacing instruction-opcode bytes with the INT3 opcode.

#BP cannot be disabled.

Error Code Returned. None.

Program Restart. #BP is a trap-type exception. The saved instruction pointer points to the byte after the INT3 instruction. This location can be the start of the next instruction. However, if the INT3 is used to replace the first opcode bytes of an instruction, the restart location is likely to be in the middle of an instruction. In the latter case, the debug software must replace the INT3 byte with the correct instruction byte. The saved RIP instruction pointer must then be decremented by one before returning to the interrupted program. This allows the program to be restarted correctly on the interrupted-instruction boundary.

8.2.5 #OF—Overflow Exception (Vector 4)

An #OF exception occurs as a result of executing an INTO instruction while the overflow bit in RFLAGS is set to 1 (RFLAGS.OF=1).

#OF cannot be disabled.

Error Code Returned. None.

Program Restart. #OF is a trap-type exception. The saved instruction pointer points to the instruction following the INTO instruction that caused the #OF.

8.2.6 #BR—Bound-Range Exception (Vector 5)

A #BR exception can occur as a result of executing the BOUND instruction. The BOUND instruction compares an array index (first operand) with the lower bounds and upper bounds of an array (second operand). If the array index is not within the array boundary, the #BR occurs.

#BR cannot be disabled.

Error Code Returned. None.

Program Restart. #BR is a fault-type exception. The saved instruction pointer points to the BOUND instruction that caused the #BR.

8.2.7 #UD—Invalid-Opcode Exception (Vector 6)

A #UD exception occurs when an attempt is made to execute an invalid or undefined opcode. The validity of an opcode often depends on the processor operating mode. A #UD occurs under the following conditions:

- Execution of any reserved or undefined opcode in any mode.
- Execution of the UD2 instruction.
- Use of the LOCK prefix on an instruction that cannot be locked.
- Use of the LOCK prefix on a lockable instruction with a non-memory target location.
- Execution of an instruction with an invalid-operand type.
- Execution of the SYSENTER or SYSEXIT instructions in long mode.
- Execution of any of the following instructions in 64-bit mode: AAA, AAD, AAM, AAS, BOUND, CALL (opcode 9A), DAA, DAS, DEC, INC, INTO, JMP (opcode EA), LDS, LES, POP (DS, ES, SS), POPA, PUSH (CS, DS, ES, SS), PUSHA, SALC.
- Execution of the ARPL, LAR, LLDT, LSL, LTR, SLDT, STR, VERR, or VERW instructions when protected mode is not enabled, or when virtual-8086 mode is enabled.
- Execution of any 128-bit media instruction when CR4.OSFXSR is cleared to 0. (For further information, see “FXSAVE/FXRSTOR Support (OSFXSR) Bit” on page 49.

- Execution of any 128-bit media instruction (uses XMM registers), or 64-bit media instruction (uses MMX™ registers) when CR0.EM = 1.
- Execution of any 128-bit media floating-point instruction (uses XMM registers) that causes a numeric exception when CR4.OSXMMEXCPT = 0.
- Use of the DR4 or DR5 debug registers when CR4.DE = 1.
- Execution of RSM when not in SMM mode.

See the specific instruction description (in the other volumes) for additional information on invalid conditions.

#UD cannot be disabled.

Error Code Returned. None.

Program Restart. #UD is a fault-type exception. The saved instruction pointer points to the instruction that caused the #UD.

8.2.8 #NM—Device-Not-Available Exception (Vector 7)

A #NM exception occurs under any of the following conditions:

- An FWAIT/WAIT instruction is executed when CR0.MP=1 and CR0.TS=1.
- Any x87 instruction other than FWAIT is executed when CR0.EM=1.
- Any x87 instruction is executed when CR0.TS=1. The CR0.MP bit controls whether the FWAIT/WAIT instruction causes an #NM exception when TS=1.
- Any 128-bit or 64-bit media instruction when CR0.TS=1.

#NM can be enabled or disabled under the control of the CR0.MP, CR0.EM, and CR0.TS bits as described above. See “CR0 Register” on page 42 for more information on the CR0 bits used to control the #NM exception.

Error Code Returned. None.

Program Restart. #NM is a fault-type exception. The saved instruction pointer points to the instruction that caused the #NM.

8.2.9 #DF—Double-Fault Exception (Vector 8)

A #DF exception can occur when a second exception occurs during the handling of a prior (first) exception or interrupt handler.

Usually, the first and second exceptions can be handled sequentially without resulting in a #DF. In this case, the first exception is considered *benign*, as it does not harm the ability of the processor to handle the second exception.

In some cases, however, the first exception adversely affects the ability of the processor to handle the second exception. These exceptions contribute to the occurrence of a #DF, and are called *contributory*

exceptions. If a contributory exception is followed by another contributory exception, a double-fault exception occurs. Likewise, if a page fault is followed by another page fault or a contributory exception, a double-fault exception occurs.

Table 8-3 shows the conditions under which a #DF occurs. Page faults are either benign or contributory, and are listed separately. See the “Class” column in Table 8-2 on page 210 for information on whether an exception is benign or contributory.

Table 8-3. Double-Fault Exception Conditions

First Interrupting Event	Second Interrupting Event
Contributory Exceptions <ul style="list-style-type: none"> • Divide-by-Zero-Error Exception • Invalid-TSS Exception • Segment-Not-Present Exception • Stack Exception • General-Protection Exception 	Invalid-TSS Exception Segment-Not-Present Exception Stack Exception General-Protection Exception
Page Fault Exception	Page Fault Exception Invalid-TSS Exception Segment-Not-Present Exception Stack Exception General-Protection Exception

If a third interrupting event occurs while transferring control to the #DF handler, the processor shuts down. Only an NMI, RESET, or INIT can restart the processor in this case. However, if the processor shuts down as it is executing an NMI handler, the processor can only be restarted with RESET or INIT.

#DF cannot be disabled.

Error Code Returned. Zero.

Program Restart. #DF is an abort-type exception. The saved instruction pointer is undefined, and the program cannot be restarted.

8.2.10 Coprocessor-Segment-Overrun Exception (Vector 9)

This interrupt vector is reserved. It is for a discontinued exception originally used by processors that supported external x87-instruction coprocessors. On those processors, the exception condition is caused by an invalid-segment or invalid-page access on an x87-instruction coprocessor-instruction operand. On current processors, this condition causes a general-protection exception to occur.

Error Code Returned. Not applicable.

Program Restart. Not applicable.

8.2.11 #TS—Invalid-TSS Exception (Vector 10)

A #TS exception occurs when an invalid reference is made to a segment selector as part of a task switch. A #TS also occurs during a privilege-changing control transfer (through a call gate or an interrupt gate), if a reference is made to an invalid stack-segment selector located in the TSS. Table 8-4 lists the conditions under which a #TS occurs and the error code returned by the exception mechanism.

#TS cannot be disabled.

Error Code Returned. See Table 8-4 for a list of error codes returned by the #TS exception.

Program Restart. #TS is a fault-type exception. If the exception occurs before loading the segment selectors from the TSS, the saved instruction pointer points to the instruction that caused the #TS. However, most #TS conditions occur due to errors with the loaded segment selectors. When an error is found with a segment selector, the hardware task-switch mechanism completes loading the new task state from the TSS, and then triggers the #TS exception mechanism. In this case, the saved instruction pointer points to the first instruction in the new task.

In long mode, a #TS cannot be caused by a task switch, because the hardware task-switch mechanism is disabled. A #TS occurs only as a result of a control transfer through a gate descriptor that results in an invalid stack-segment reference using an SS selector in the TSS. In this case, the saved instruction pointer always points to the control-transfer instruction that caused the #TS.

Table 8-4. Invalid-TSS Exception Conditions

Selector Reference	Error Condition	Error Code
Task-State Segment	TSS limit check on a task switch	TSS Selector Index
	TSS limit check on an inner-level stack pointer	
LDT Segment	LDT does not point to GDT	LDT Selector Index
	LDT reference outside GDT	
	GDT entry is not an LDT descriptor	
	LDT descriptor is not present	
Code Segment	CS reference outside GDT or LDT	CS Selector Index
	Privilege check (conforming DPL > CPL)	
	Privilege check (non-conforming DPL ≠ CPL)	
	Type check (CS not executable)	
Data Segment	Data segment reference outside GDT or LDT	DS, ES, FS or GS Selector Index
	Type check (data segment not readable)	
Stack Segment	SS reference outside GDT or LDT	SS Selector Index
	Privilege check (stack segment descriptor DPL ≠ CPL)	
	Privilege check (stack segment selector RPL ≠ CPL)	
	Type check (stack segment not writable)	

8.2.12 #NP—Segment-Not-Present Exception (Vector 11)

An #NP occurs when an attempt is made to load a segment or gate with a clear present bit, as described in the following situations:

- Using the MOV, POP, LDS, LES, LFS, or LGS instructions to load a segment selector (DS, ES, FS, and GS) that references a segment descriptor containing a clear present bit (descriptor.P=0).
- Far transfer to a CS that is not present.
- Referencing a gate descriptor containing a clear present bit.
- Referencing a TSS descriptor containing a clear present bit. This includes attempts to load the TSS descriptor using the LTR instruction.
- Attempting to load a descriptor containing a clear present bit into the LDTR using the LLDT instruction.
- Loading a segment selector (CS, DS, ES, FS, or GS) as part of a task switch, with the segment descriptor referenced by the segment selector having a clear present bit. In long mode, an #NP cannot be caused by a task switch, because the hardware task-switch mechanism is disabled.

When loading a stack-segment selector (SS) that references a descriptor with a clear present bit, a stack exception (#SS) occurs. For information on the #SS exception, see the next section, “#SS—Stack Exception (Vector 12).”

#NP cannot be disabled.

Error Code Returned. The segment-selector index of the segment descriptor causing the #NP exception.

Program Restart. #NP is a fault-type exception. In most cases, the saved instruction pointer points to the instruction that loaded the segment selector resulting in the #NP. See “Exceptions During a Task Switch” on page 224 for a description of the consequences when this exception occurs during a task switch.

8.2.13 #SS—Stack Exception (Vector 12)

An #SS exception can occur in the following situations:

- Implied stack references in which the stack address is not in canonical form. Implied stack references include all push and pop instructions, and any instruction using RSP or RBP as a base register.
- Attempting to load a stack-segment selector that references a segment descriptor containing a clear present bit (descriptor.P=0).
- Any stack access that fails the stack-limit check.

#SS cannot be disabled.

Error Code Returned. The error code depends on the cause of the #SS, as shown in Table 8-5 on page 218:

Table 8-5. Stack Exception Error Codes

Stack Exception Cause	Error Code
Stack-segment descriptor present bit is clear	SS Selector Index
Stack-limit violation	0
Stack reference using a non-canonical address	0

Program Restart. #SS is a fault-type exception. In most cases, the saved instruction pointer points to the instruction that caused the #SS. See “Exceptions During a Task Switch” on page 224 for a description of the consequences when this exception occurs during a task switch.

8.2.14 #GP—General-Protection Exception (Vector 13)

Table 8-6 describes the general situations that can cause a #GP exception. The table is not an exhaustive, detailed list of #GP conditions, but rather a guide to the situations that can cause a #GP. If an invalid use of an AMD64 architectural feature results in a #GP, the specific cause of the exception is described in detail in the section describing the architectural feature.

#GP cannot be disabled.

Error Code Returned. As shown in Table 8-6, a selector index is reported as the error code if the #GP is due to a segment-descriptor access. In all other cases, an error code of 0 is returned.

Program Restart. #GP is a fault-type exception. In most cases, the saved instruction pointer points to the instruction that caused the #GP. See “Exceptions During a Task Switch” on page 224 for a description of the consequences when this exception occurs during a task switch.

Table 8-6. General-Protection Exception Conditions

Error Condition	Error Code
Any segment privilege-check violation, while loading a segment register.	Selector Index
Any segment type-check violation, while loading a segment register.	
Loading a null selector into the CS, SS, or TR register.	
Accessing a gate-descriptor containing a null segment selector.	
Referencing an LDT descriptor or TSS descriptor located in the LDT.	
Attempting a control transfer to a busy TSS (except IRET).	
In 64-bit mode, loading a non-canonical base address into the GDTR or IDTR.	
In long mode, accessing a system or call-gate descriptor whose extended type field is not 0.	
In long mode, accessing a system descriptor containing a non-canonical base address.	
In long mode, accessing a gate descriptor containing a non-canonical offset.	
In long mode, accessing a gate descriptor that does not point to a 64-bit code segment.	
In long mode, accessing a 16-bit gate descriptor.	
In long mode, attempting a control transfer to a TSS or task gate.	

Table 8-6. General-Protection Exception Conditions (continued)

Error Condition	Error Code
Any segment limit-check or non-canonical address violation (except when using the SS register).	0
Accessing memory using a null segment register.	
Writing memory using a read-only segment register.	
Using a 128-bit media instruction requiring 16-byte alignment with a memory operand not aligned on a 16-byte boundary.	
Attempting to execute code that is past the CS segment limit or at a non-canonical RIP.	
Executing a privileged instruction while CPL > 0.	
Executing an instruction that is more than 15 bytes long.	
Writing a 1 into any register field that is reserved, must be zero (MBZ).	
Using WRMSR to write a read-only MSR.	
Using WRMSR to write a non-canonical value into an MSR that must be canonical.	
Using WRMSR to set an invalid type encoding in an MTRR or the PAT MSR.	
Enabling paging while protected mode is disabled.	
Setting CR0.NW=1 while CR0.CD=0.	
Any long-mode consistency-check violation.	

8.2.15 #PF—Page-Fault Exception (Vector 14)

A #PF exception can occur during a memory access in any of the following situations:

- A page-translation-table entry or physical page involved in translating the memory access is not present in physical memory. This is indicated by a cleared present bit (P=0) in the translation-table entry.
- An attempt is made by the processor to load the instruction TLB with a translation for a non-executable page.
- The memory access fails the paging-protection checks (user/supervisor, read/write, or both).
- A reserved bit in one of the page-translation-table entries is set to 1. A #PF occurs for this reason only when CR4.PSE=1 or CR4.PAE=1.

#PF cannot be disabled.

CR2 Register. The virtual (linear) address that caused the #PF is stored in the CR2 register. The legacy CR2 register is 32 bits long. The CR2 register in the AMD64 architecture is 64 bits long, as shown in Figure 8-1 on page 220. In AMD64 implementations, when either software or a page fault causes a write to the CR2 register, only the low-order 32 bits of CR2 are used in legacy mode; the processor clears the high-order 32 bits.

63

0

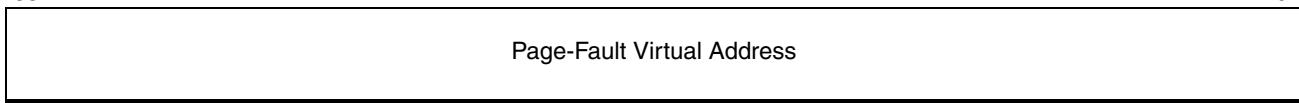

Figure 8-1. Control Register 2 (CR2)

Error Code Returned. The page-fault error code is pushed onto the page-fault exception-handler stack. See “Page-Fault Error Code” on page 225 for a description of this error code.

Program Restart. #PF is a fault-type exception. In most cases, the saved instruction pointer points to the instruction that caused the #PF. See “Exceptions During a Task Switch” on page 224 for a description of what can happen if this exception occurs during a task switch.

8.2.16 #MF—x87 Floating-Point Exception-Pending (Vector 16)

The #MF exception is used to handle unmasked x87 floating-point exceptions. An #MF occurs when *all* of the following conditions are true:

- CR0.NE=1.
- An unmasked x87 floating-point exception is pending. This is indicated by an exception bit in the x87 floating-point status-word register being set to 1
- The corresponding mask bit in the x87 floating-point control-word register is cleared to 0.
- The FWAIT/WAIT instruction or any waiting floating-point instruction is executed.

If there is an exception mask bit (in the FPU control word) set, the exception is not reported. Instead, the x87-instruction unit responds in a default manner and execution proceeds normally.

The x87 floating-point exceptions reported by the #MF exception are (including mnemonics):

- IE—Invalid-operation exception (also called #I), which is either:
 - IE alone—Invalid arithmetic-operand exception (also called #IA), or
 - SF and IE together—x87 Stack-fault exception (also called #IS).
- DE—Denormalized-operand exception (also called #D).
- ZE—Zero-divide exception (also called #Z).
- OE—Overflow exception (also called #O).
- UE—Underflow exception (also called #U).
- PE—Precision exception (also called #P or inexact-result exception).

Error Code Returned. None. Exception information is provided by the x87 status-word register. See “x87 Floating-Point Programming” in Volume 1 for more information on using this register.

Program Restart. #MF is a fault-type exception. The #MF exception is not precise, because multiple instructions and exceptions can occur before the #MF handler is invoked. Also, the saved instruction

pointer does not point to the instruction that caused the exception resulting in the #MF. Instead, the saved instruction pointer points to the x87 floating-point instruction or FWAIT/WAIT instruction that is about to be executed when the #MF occurs. The address of the *last instruction* that caused an x87 floating-point exception is in the x87 instruction-pointer register. See “x87 Floating-Point Programming” in Volume 1 for information on accessing this register.

Masking. Each type of x87 floating-point exception can be masked by setting the appropriate bits in the x87 control-word register. See “x87 Floating-Point Programming” in Volume 1 for more information on using this register.

#MF can also be disabled by clearing the CR0.NE bit to 0. See “Numeric Error (NE) Bit” on page 44 for more information on using this bit.

8.2.17 #AC—Alignment-Check Exception (Vector 17)

An #AC exception occurs when an unaligned-memory data reference is performed while alignment checking is enabled.

After a processor reset, #AC exceptions are disabled. Software enables the #AC exception by setting the following register bits:

- CR0.AM=1.
- RFLAGS.AC=1.

When the above register bits are set, an #AC can occur only when CPL=3. #AC never occurs when CPL < 3.

Table 8-7 lists the data types and the alignment boundary required to *avoid* an #AC exception when the mechanism is enabled.

Table 8-7. Data-Type Alignment

Supported Data Type	Required Alignment (Byte Boundary)
Word	2
Doubleword	4
Quadword	8
Bit string	2, 4 or 8 (depends on operand size)
128-bit media	16
64-bit media	8
Segment selector	2
32-bit near pointer	4
32-bit far pointer	2
48-bit far pointer	4
x87 Floating-point single-precision	4

Table 8-7. Data-Type Alignment (continued)

Supported Data Type	Required Alignment (Byte Boundary)
x87 Floating-point double-precision	8
x87 Floating-point extended-precision	8
x87 Floating-point save areas	2 or 4 (depends on operand size)

Error Code Returned. Zero.

Program Restart. #AC is a fault-type exception. The saved instruction pointer points to the instruction that caused the #AC.

8.2.18 #MC—Machine-Check Exception (Vector 18)

The #MC exception is model specific. Processor implementations are not required to support the #MC exception, and those implementations that do support #MC can vary in how the #MC exception mechanism works.

The exception is enabled by setting CR4.MCE to 1. The machine-check architecture can include model-specific masking for controlling the reporting of some errors. Refer to Chapter 9, “Machine Check Mechanism,” for more information.

Error Code Returned. None. Error information is provided by model-specific registers (MSRs) defined by the machine-check architecture.

Program Restart. #MC is an abort-type exception. There is no reliable way to restart the program. If the EIPV flag (EIP valid) is set in the MCG_Status MSR, the saved CS and rIP point to the instruction that caused the error. If EIP is clear, the CS:rIP of the instruction causing the failure is not known or the machine check is not related to a specific instruction.

8.2.19 #XF—SIMD Floating-Point Exception (Vector 19)

The #XF exception is used to handle unmasked 128-bit media floating-point exceptions. A #XF exception occurs when all of the following conditions are true:

- A 128-bit media floating-point exception occurs. The exception causes the processor to set the appropriate exception-status bit in the MXCSR register to 1.
- The exception-mask bit in the MXCSR that corresponds to the 128-bit media floating-point exception is clear (=0).
- CR4.OSXMMEXCPT=1, indicating that the operating system supports handling of 128-bit media floating-point exceptions.

The exception-mask bits are used by software to specify the handling of 128-bit media floating-point exceptions. When the corresponding mask bit is cleared to 0, an exception occurs under the control of the CR4.OSXMMEXCPT bit. However, if the mask bit is set to 1, the 128-bit media floating-point unit responds in a default manner and execution proceeds normally.

The CR4.OSXMMEXCPT bit specifies the interrupt vector to be taken when an unmasked 128-bit media floating-point exception occurs. When CR4.OSXMMEXCPT=1, the #XF interrupt vector is taken when an exception occurs. When CR4.OSXMMEXCPT=0, the #UD (undefined opcode) interrupt vector is taken when an exception occurs.

The 128-bit media floating-point exceptions reported by the #XF exception are (including mnemonics):

- IE—Invalid-operation exception (also called #I).
- DE—Denormalized-operand exception (also called #D).
- ZE—Zero-divide exception (also called #Z).
- OE—Overflow exception (also called #O).
- UE—Underflow exception (also called #U).
- PE—Precision exception (also called #P or inexact-result exception).

Each type of 128-bit media floating-point exception can be masked by setting the appropriate bits in the MXCSR register. #XF can also be disabled by clearing the CR4.OSXMMEXCPT bit to 0.

Error Code Returned. None. Exception information is provided by the 128-bit media floating-point MXCSR register. See “128-Bit Media and Scientific Programming” in Volume 1 for more information on using this register.

Program Restart. #XF is a fault-type exception. Unlike the #MF exception, the #XF exception is precise. The saved instruction pointer points to the instruction that caused the #XF.

8.2.20 User-Defined Interrupts (Vectors 32–255)

User-defined interrupts can be initiated either by system logic or software. They occur when:

- System logic signals an external interrupt request to the processor. The signalling mechanism and the method of communicating the interrupt vector to the processor are implementation dependent.
- Software executes an INT n instruction. The INT n instruction operand provides the interrupt vector number.

Both methods can be used to initiate an interrupt into vectors 0 through 255. However, because vectors 0 through 31 are defined or reserved by the AMD64 architecture, software should not use vectors in this range for purposes other than their defined use.

Error Code Returned. None.

Program Restart. The saved instruction pointer depends on the interrupt source:

- External interrupts are recognized on instruction boundaries. The saved instruction pointer points to the instruction immediately following the boundary where the external interrupt was recognized.

- If the interrupt occurs as a result of executing the $INTn$ instruction, the saved instruction pointer points to the instruction after the $INTn$.

Masking. The ability to mask user-defined interrupts depends on the interrupt source:

- External interrupts can be masked using the `rFLAGS.IF` bit. Setting `rFLAGS.IF` to 1 enables external interrupts, while clearing `rFLAGS.IF` to 0 inhibits them.
- Software interrupts (initiated by the $INTn$ instruction) cannot be disabled.

8.3 Exceptions During a Task Switch

An exception can occur during a task switch while loading a segment selector. Page faults can also occur when accessing a TSS. In these cases, the hardware task-switch mechanism completes loading the new task state from the TSS, and then triggers the appropriate exception mechanism. No other checks are performed. When this happens, the saved instruction pointer points to the first instruction in the new task.

In long mode, an exception cannot occur during a task switch, because the hardware task-switch mechanism is disabled.

8.4 Error Codes

The processor exception-handling mechanism reports error and status information for some exceptions using an error code. The error code is pushed onto the stack by the exception-mechanism during the control transfer into the exception handler. The error code has two formats: a selector format for most error-reporting exceptions, and a page-fault format for page faults. These formats are described in the following sections.

8.4.1 Selector-Error Code

Figure 8-2 shows the format of the selector-error code.

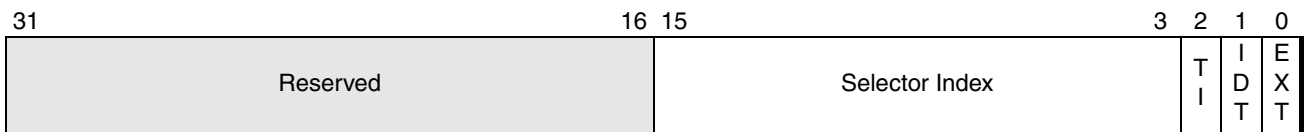

Figure 8-2. Selector Error Code

The information reported by the selector-error code includes:

- *EXT*—Bit 0. If this bit is set to 1, the exception source is external to the processor. If cleared to 0, the exception source is internal to the processor.
- *IDT*—Bit 1. If this bit is set to 1, the error-code selector-index field references a gate descriptor located in the interrupt-descriptor table (IDT). If cleared to 0, the selector-index field references a

descriptor in either the global-descriptor table (GDT) or local-descriptor table (LDT), as indicated by the TI bit.

- *TI*—Bit 2. If this bit is set to 1, the error-code selector-index field references a descriptor in the LDT. If cleared to 0, the selector-index field references a descriptor in the GDT. The TI bit is relevant only when the IDT bit is cleared to 0.
- *Selector Index*—Bits 15–3. The selector-index field specifies the index into either the GDT, LDT, or IDT, as specified by the IDT and TI bits.

Some exceptions return a zero in the selector-error code.

8.4.2 Page-Fault Error Code

Figure 8-3 shows the format of the page-fault error code.

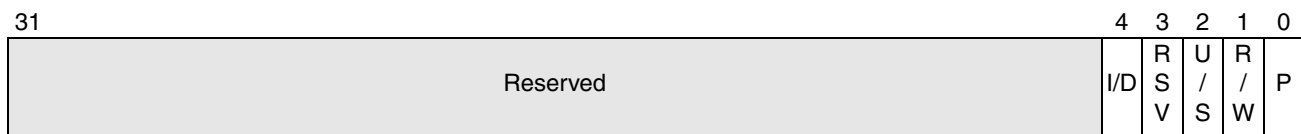

Figure 8-3. Page-Fault Error Code

The information reported by the page-fault error code includes:

- *P*—Bit 0. If this bit is cleared to 0, the page fault was caused by a not-present page. If this bit is set to 1, the page fault was caused by a page-protection violation.
- *R/W*—Bit 1. If this bit is cleared to 0, the access that caused the page fault is a memory read. If this bit is set to 1, the memory access that caused the page fault was a write. This bit does not necessarily indicate the cause of the page fault was a read or write violation.
- *U/S*—Bit 2. If this bit is cleared to 0, an access in supervisor mode (CPL=0, 1, or 2) caused the page fault. If this bit is set to 1, an access in user mode (CPL=3) caused the page fault. This bit does not necessarily indicate the cause of the page fault was a privilege violation.
- *RSV*—Bit 3. If this bit is set to 1, the page fault is a result of the processor reading a 1 from a reserved field within a page-translation-table entry. This type of page fault occurs only when CR4.PSE=1 or CR4.PAE=1. If this bit is cleared to 0, the page fault was not caused by the processor reading a 1 from a reserved field.
- *I/D*—Bit 4. If this bit is set to 1, it indicates that the access that caused the page fault was an instruction fetch. Otherwise, this bit is cleared to 0. This bit is only defined if no-execute feature is enabled (EFER.NXE=1 && CR4.PAE=1).

8.5 Priorities

To allow for consistent handling of multiple-interrupt conditions, simultaneous interrupts are prioritized by the processor. The AMD64 architecture defines priorities between groups of interrupts,

and interrupt prioritization within a group is implementation dependent. Table 8-8 shows the interrupt priorities defined by the AMD64 architecture.

When simultaneous interrupts occur, the processor transfers control to the highest-priority interrupt handler. Lower-priority interrupts from external sources are held pending by the processor, and they are handled after the higher-priority interrupt is handled. Lower-priority interrupts that result from internal sources are discarded. Those interrupts reoccur when the high-priority interrupt handler completes and transfers control back to the interrupted instruction. Software interrupts are discarded as well, and reoccur when the software-interrupt instruction is restarted.

Table 8-8. Simultaneous Interrupt Priorities

Interrupt Priority	Interrupt Condition	Interrupt Vector
(High) 0	Processor Reset	—
	Machine-Check Exception	18
1	External Processor Initialization (INIT)	—
	SMI Interrupt	
	External Clock Stop (Stpclk)	
2	Data, and I/O Breakpoint (Debug Register)	1
	Single-Step Execution Instruction Trap (rFLAGS.TF=1)	
3	Non-Maskable Interrupt	2
4	Maskable External Interrupt (INTR)	32—255
5	Instruction Breakpoint (Debug Register)	1
	Code-Segment-Limit Violation	13
	Instruction-Fetch Page Fault	14
6	Invalid Opcode Exception	6
	Device-Not-Available Exception	7
	Instruction-Length Violation (> 15 Bytes)	13
7	Divide-by-zero Exception	0
	Invalid-TSS Exception	10
	Segment-Not-Present Exception	11
	Stack Exception	12
	General-Protection Exception	13
	Data-Access Page Fault	14
	Floating-Point Exception-Pending Exception	16
	Alignment-Check Exception	17
SIMD Floating-Point Exception	19	

8.5.1 Floating-Point Exception Priorities

Floating-point exceptions (128-bit media and x87 floating-point) can be handled in one of two ways:

- Unmasked exceptions are reported in the appropriate floating-point status register, and a software-interrupt handler is invoked. See “#MF—x87 Floating-Point Exception-Pending (Vector 16)” on page 220 and “#XF—SIMD Floating-Point Exception (Vector 19)” on page 223 for more information on the floating-point interrupts.
- Masked exceptions are also reported in the appropriate floating-point status register. Instead of transferring control to an interrupt handler, however, the processor handles the exception in a default manner and execution proceeds.

If the processor detects more than one exception while executing a single floating-point instruction, it prioritizes the exceptions in a predictable manner. When responding in a default manner to masked exceptions, it is possible that the processor acts only on the high-priority exception and ignores lower-priority exceptions. In the case of vector (SIMD) floating-point instructions, priorities are set on sub-operations, not across all operations. For example, if the processor detects and acts on a QNaN operand in one sub-operation, the processor can still detect and act on a denormal operand in another sub-operation.

When reporting 128-bit media floating-point exceptions before taking an interrupt or handling them in a default manner, the processor first classifies the exceptions as follows:

- *Input exceptions* include SNaN operand (#I), invalid operation (#I), denormal operand (#D), or zero-divide (#Z). Using a NaN operand with a maximum, minimum, compare, or convert instruction is also considered an input exception.
- *Output exceptions* include numeric overflow (#O), numeric underflow (#U), and precision (#P).

Using the above classification, the processor applies the following procedure to report the exceptions:

1. The exceptions for all sub-operations are prioritized.
2. The exception conditions for all sub-operations are logically ORed together to form a single set of exceptions covering all operations. For example, if two sub-operations produce a denormal result, only one denormal exception is reported.
3. If the set of exceptions includes any *unmasked* input exceptions, all input exceptions are reported in MCXSR, and no output exceptions are reported. Otherwise, all input and output exceptions are reported in MCXSR.
4. If any exceptions are unmasked, control is transferred to the appropriate interrupt handler.

Table 8-9 on page 228 lists the priorities for simultaneous floating-point exceptions.

Table 8-9. Simultaneous Floating-Point Exception Priorities

Exception Priority	Exception Condition	
(High) 0	SNaN Operand	#I
	NaN Operand of Maximum, Minimum, Compare, and Convert Instructions (Vector Floating-Point)	
	Stack Overflow (x87 Floating-Point)	
	Stack Underflow (x87 Floating-Point)	
1	QNaN Operand	—
2	Invalid Operation (Remaining Conditions)	#I
	Zero Divide	#Z
3	Denormal Operand	#D
4	Numeric Overflow	#O
	Numeric Underflow	#U
5 (Low)	Precision	#P

8.5.2 External Interrupt Priorities

The AMD64 architecture allows software to define up to 15 external interrupt-priority classes. Priority classes are numbered from 1 to 15, with priority-class 1 being the lowest and priority-class 15 the highest. The organization of these priority classes is implementation dependent. A typical method is to use the upper four bits of the interrupt vector number to define the priority. Thus, interrupt vector 53h has a priority of 5 and interrupt vector 37h has a priority of 3.

A new control register (CR8) is introduced by the AMD64 architecture for managing priority classes. This register, called the *task-priority register* (TPR), uses its four low-order bits to specify a task priority. The remaining 60 bits are reserved and must be written with zeros. Figure 8-4 shows the format of the TPR.

The TPR is available only in 64-bit mode.

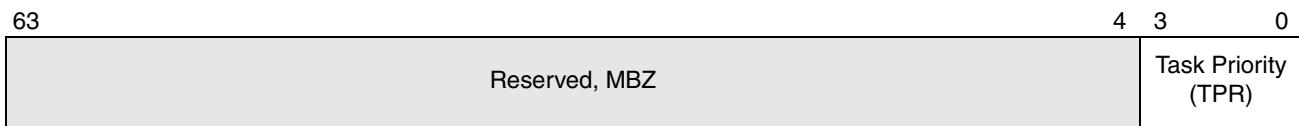

Figure 8-4. Task Priority Register (CR8)

System software can use the TPR register to temporarily block low-priority interrupts from interrupting a high-priority task. This is accomplished by loading TPR with a value corresponding to the highest-priority interrupt that is to be blocked. For example, loading TPR with a value of 9 (1001b) blocks all interrupts with a priority class of 9 or less, while allowing all interrupts with a priority class

of 10 or more to be recognized. Loading TPR with 0 enables all external interrupts. Loading TPR with 15 (1111b) disables all external interrupts. The TPR is cleared to 0 on reset.

System software reads and writes the TPR using a MOV CR8 instruction. The MOV CR8 instruction requires a privilege level of 0. Programs running at any other privilege level cannot read or write the TPR, and an attempt to do so results in a general-protection exception (#GP).

A serializing instruction is not required after loading the TPR, because a new priority level is established when the MOV instruction completes execution. For example, assume two sequential TPR loads are performed, in which a low value is first loaded into TPR and immediately followed by a load of a higher value. Any pending, lower-priority interrupt enabled by the first MOV CR8 is recognized between the two MOVs.

The TPR is an architectural abstraction of the interrupt controller (IC), which prioritizes and manages external interrupt delivery to the processor. The IC can be an external system device, or it can be integrated on the chip like the local advanced programmable interrupt controller (APIC). Typically, the IC contains a priority mechanism similar, if not identical to, the TPR. The IC, however, is implementation dependent, and the underlying priority mechanisms are subject to change. The TPR, by contrast, is part of the AMD64 architecture.

Effect of IC on TPR. The features of the implementation-specific IC can impact the operation of the TPR. For example, the TPR might affect interrupt delivery only if the IC is enabled. Also, the mapping of an external interrupt to a specific interrupt priority is an implementation-specific behavior of the IC.

8.6 Real-Mode Interrupt Control Transfers

In real mode, the IDT is a table of 4-byte entries, one entry for each of the 256 possible interrupts implemented by the system. The real mode IDT is often referred to as an *interrupt-vector table*, or IVT. Table entries contain a far pointer (CS:IP pair) to an exception or interrupt handler. The base of the IDT is stored in the IDTR register, which is loaded with a value of 00h during a processor reset. Figure 8-5 on page 230 shows how the real-mode interrupt handler is located by the interrupt mechanism.

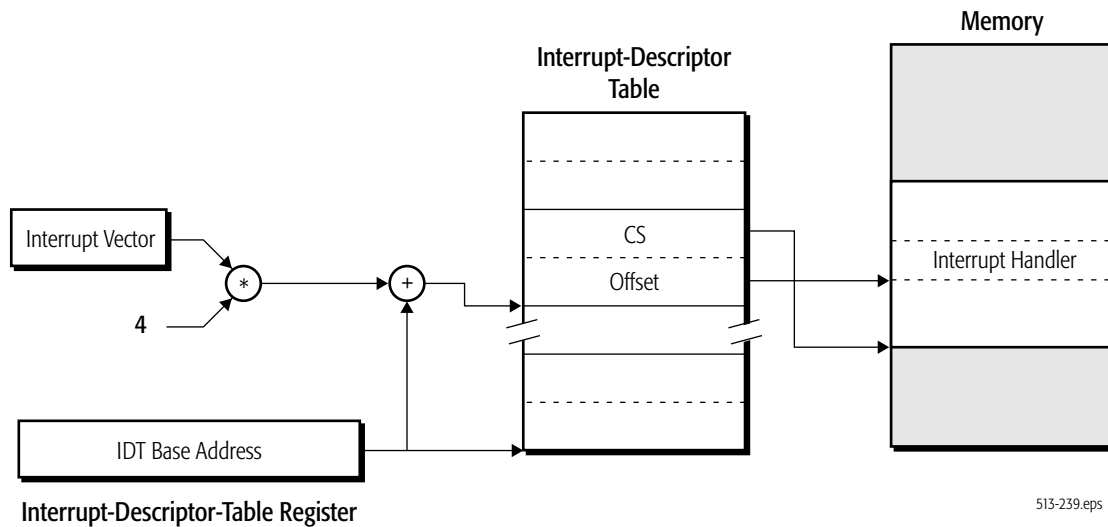

Figure 8-5. Real-Mode Interrupt Control Transfer

When an exception or interrupt occurs in real mode, the processor performs the following:

1. Pushes the FLAGS register (EFLAGS[15:0]) onto the stack.
2. Clears EFLAGS.IF to 0 and EFLAGS.TF to 0.
3. Saves the CS register and IP register (RIP[15:0]) by pushing them onto the stack.
4. Locates the interrupt-handler pointer (CS:IP) in the IDT by scaling the interrupt vector by four and adding the result to the value in the IDTR.
5. Transfers control to the interrupt handler referenced by the CS:IP in the IDT.

Figure 8-6 on page 231 shows the stack after control is transferred to the interrupt handler in real mode.

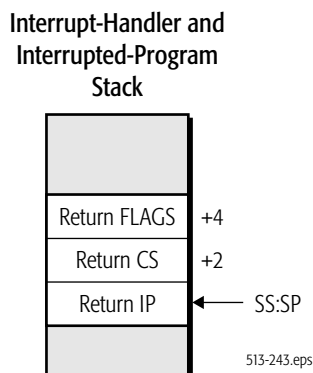

Figure 8-6. Stack After Interrupt in Real Mode

An IRET instruction is used to return to the interrupted program. When an IRET is executed, the processor performs the following:

1. Pops the saved CS value off the stack and into the CS register. The saved IP value is popped into RIP[15:0].
2. Pops the FLAGS value off of the stack and into EFLAGS[15:0].
3. Execution begins at the saved CS.IP location.

8.7 Legacy Protected-Mode Interrupt Control Transfers

In protected mode, the interrupt mechanism transfers control to an exception or interrupt handler through gate descriptors. In protected mode, the IDT is a table of 8-byte gate entries, one for each of the 256 possible interrupt vectors implemented by the system. Three gate types are allowed in the IDT:

- Interrupt gates.
- Trap gates.
- Task gates.

If a reference is made to any other descriptor type in the IDT, a general-protection exception (#GP) occurs.

Interrupt-gate control transfers are similar to CALLs and JMPs through call gates. The interrupt mechanism uses gates (interrupt, trap, and task) to establish protected entry-points into the exception and interrupt handlers.

The remainder of this chapter discusses control transfers through interrupt gates and trap gates. If the gate descriptor in the IDT is a task gate, a TSS-segment selector is referenced, and a task switch

occurs. See Chapter 12, “Task Management,” for more information on the hardware task-switch mechanism.

8.7.1 Locating the Interrupt Handler

When an exception or interrupt occurs, the processor scales the interrupt-vector number by eight and uses the result as an offset into the IDT. If the gate descriptor referenced by the IDT offset is an interrupt gate or a trap gate, it contains a segment-selector and segment-offset field (see “Legacy Segment Descriptors” on page 77 for a detailed description of the gate-descriptor format and fields). These two fields perform the same function as the pointer operand in a far control-transfer instruction. The gate-descriptor segment-selector field points to the target code-segment descriptor located in either the GDT or LDT. The gate-descriptor segment-offset field is the instruction-pointer offset into the interrupt-handler code segment. The code-segment base taken from the code-segment descriptor is added to the gate-descriptor segment-offset field to create the interrupt-handler virtual address (linear address).

Figure 8-7 on page 233 shows how the protected-mode interrupt handler is located by the interrupt mechanism.

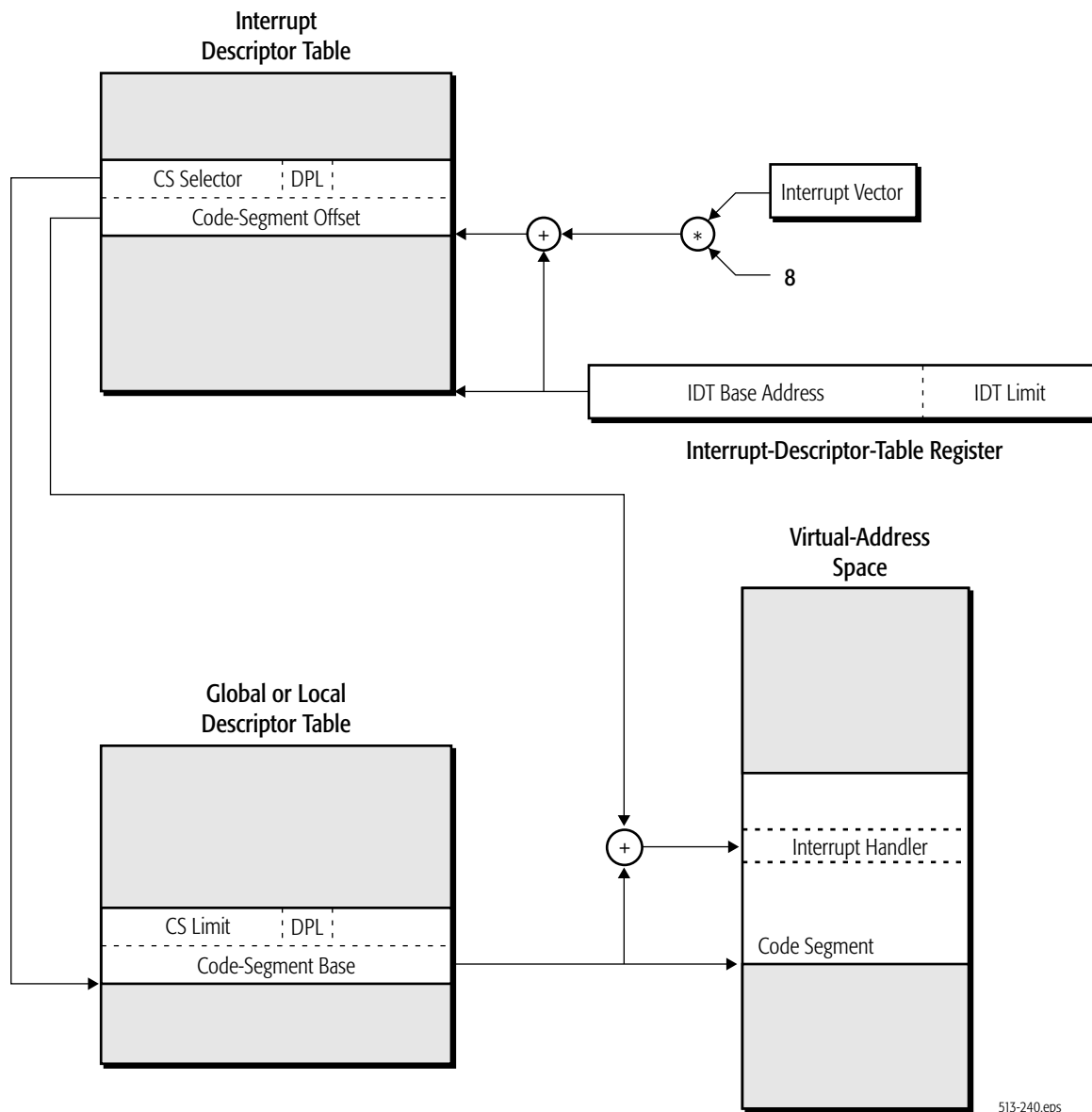

513-240.eps

Figure 8-7. Protected-Mode Interrupt Control Transfer

8.7.2 Interrupt To Same Privilege

When a control transfer to an exception or interrupt handler at the same privilege level occurs (through an interrupt gate or a trap gate), the processor performs the following:

1. Pushes the EFLAGS register onto the stack.
2. Clears the TF, NT, RF, and VM bits in EFLAGS to 0.

3. The processor handles EFLAGS.IF based on the gate-descriptor type:
 - If the gate descriptor is an interrupt gate, EFLAGS.IF is cleared to 0.
 - If the gate descriptor is a trap gate, EFLAGS.IF is not modified.
4. Saves the return CS register and EIP register (RIP[31:0]) by pushing them onto the stack. The CS value is padded with two bytes to form a doubleword.
5. If the interrupt has an associated error code, the error code is pushed onto the stack.
6. The CS register is loaded from the segment-selector field in the gate descriptor, and the EIP is loaded from the offset field in the gate descriptor.
7. The interrupt handler begins executing with the instruction referenced by new CS:EIP.

Figure 8-8 shows the stack after control is transferred to the interrupt handler.

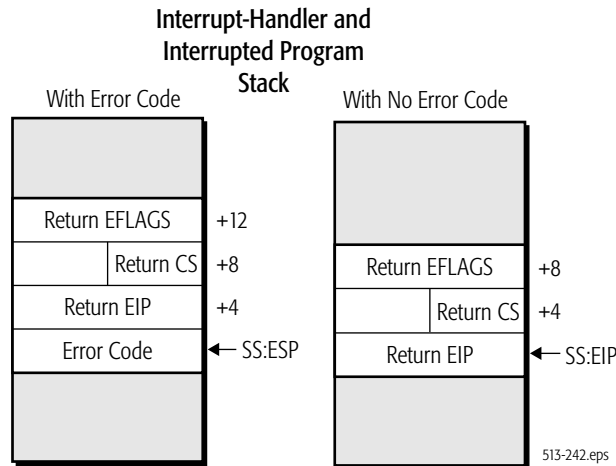

Figure 8-8. Stack After Interrupt to Same Privilege Level

8.7.3 Interrupt To Higher Privilege

When a control transfer to an exception or interrupt handler running at a higher privilege occurs (numerically lower CPL value), the processor performs a stack switch using the following steps:

1. The target CPL is read by the processor from the target code-segment DPL and used as an index into the TSS for selecting the new stack pointer (SS:ESP). For example, if the target CPL is 1, the processor selects the SS:ESP for privilege-level 1 from the TSS.
2. Pushes the return stack pointer (old SS:ESP) onto the new stack. The SS value is padded with two bytes to form a doubleword.
3. Pushes the EFLAGS register onto the new stack.
4. Clears the following EFLAGS bits to 0: TF, NT, RF, and VM.

5. The processor handles the EFLAGS.IF bit based on the gate-descriptor type:
 - If the gate descriptor is an interrupt gate, EFLAGS.IF is cleared to 0.
 - If the gate descriptor is a trap gate, EFLAGS.IF is not modified.
6. Saves the return-address pointer (CS:EIP) by pushing it onto the stack. The CS value is padded with two bytes to form a doubleword.
7. If the interrupt-vector number has an error code associated with it, the error code is pushed onto the stack.
8. The CS register is loaded from the segment-selector field in the gate descriptor, and the EIP is loaded from the offset field in the gate descriptor.
9. The interrupt handler begins executing with the instruction referenced by new CS:EIP.

Figure 8-9 shows the new stack after control is transferred to the interrupt handler.

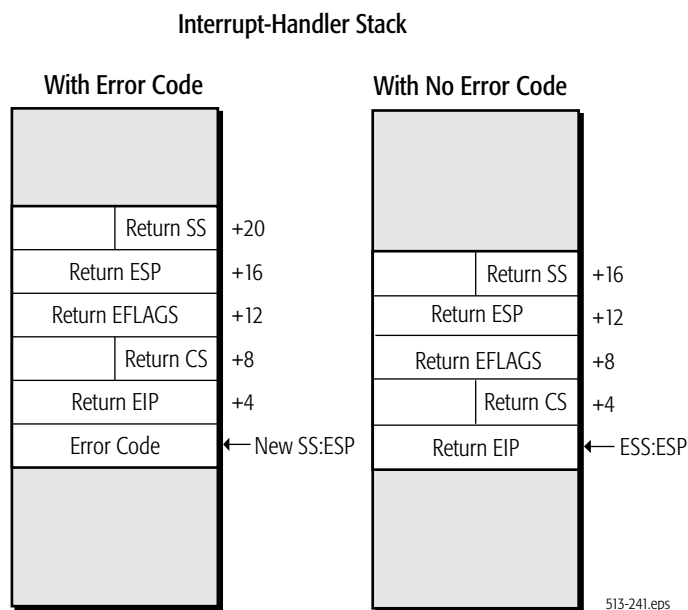

Figure 8-9. Stack After Interrupt to Higher Privilege

8.7.4 Privilege Checks

Before loading the CS register with the interrupt-handler code-segment selector (located in the gate descriptor), the processor performs privilege checks similar to those performed on call gates. The checks are performed when either conforming or nonconforming interrupt handlers are referenced:

1. The processor reads the gate DPL from the interrupt-gate or trap-gate descriptor. The gate DPL is the *minimum privilege-level* (numerically-highest value) needed by a program to access the gate. The processor compares the CPL with the gate DPL. The CPL must be numerically *less-than or equal-to* the gate DPL for this check to pass.

2. The processor compares the CPL with the interrupt-handler code-segment DPL. For this check to pass, the CPL must be numerically *greater-than or equal-to* the code-segment DPL. This check prevents control transfers to less-privileged interrupt handlers.

Unlike call gates, no RPL comparison takes place. This is because the gate descriptor is referenced in the IDT using the interrupt-vector number rather than a selector, and no RPL field exists in the interrupt-vector number.

Exception and interrupt handlers should be made reachable from software running at any privilege level that requires them. If the gate DPL value is too low (requiring more privilege), or the interrupt-handler code-segment DPL is too high (runs at lower privilege), the interrupt control transfer can fail the privilege checks. Setting the gate DPL=3 and interrupt-handler code-segment DPL=0 makes the exception handler or interrupt handler reachable from any privilege level.

Figure 8-10 on page 237 shows two examples of interrupt privilege checks. In Example 1, both privilege checks pass:

- The interrupt-gate DPL is at the lowest privilege (3), which means that software running at any privilege level (CPL) can access the interrupt gate.
- The interrupt-handler code segment is at the highest-privilege level, as indicated by DPL=0. This means software running at any privilege can enter the interrupt handler through the interrupt gate.

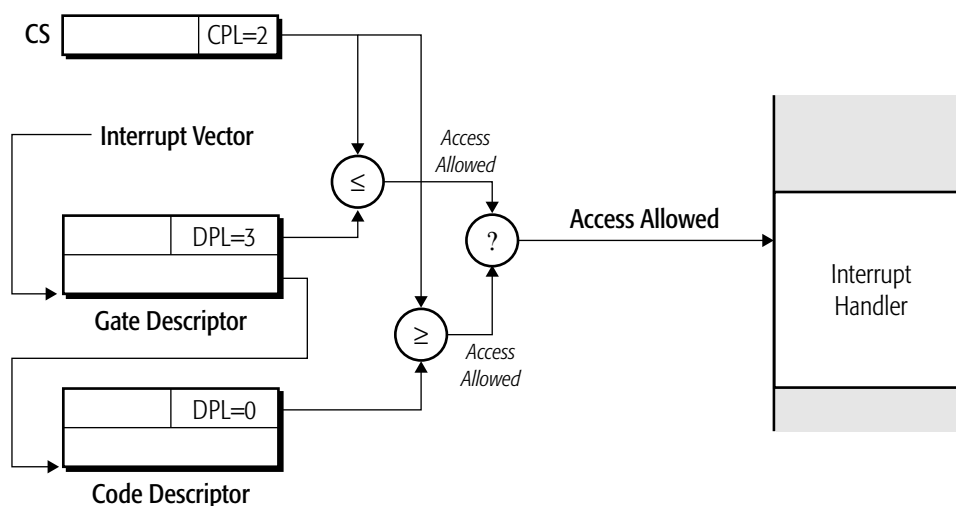

Example 1: Privilege Check Passes

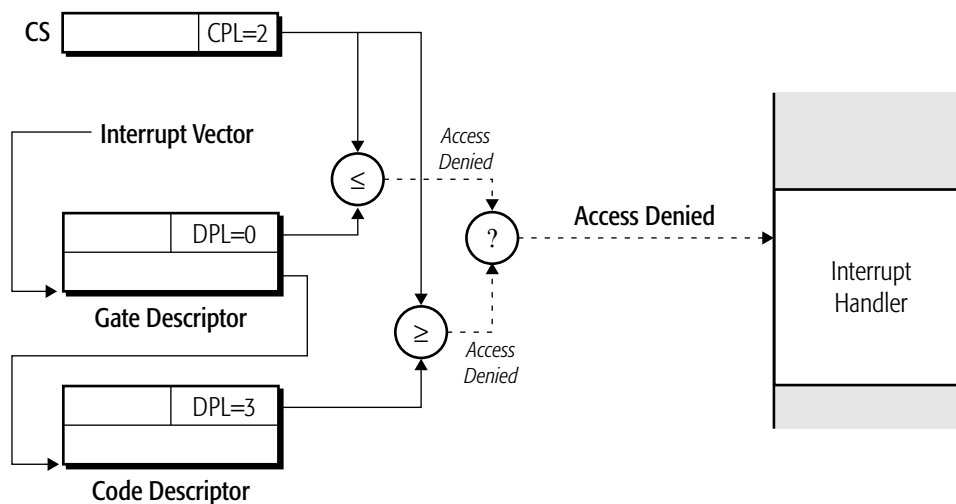

Example 2: Privilege Check Fails

513-244.eps

Figure 8-10. Privilege-Check Examples for Interrupts

In Example 2, both privilege checks fail:

- The interrupt-gate DPL specifies that only software running at privilege-level 0 can access the gate. The current program does not have a high enough privilege level to access the interrupt gate, since its CPL is set at 2.

- The interrupt handler has a lower privilege (DPL=3) than the currently-running software (CPL=2). Transitions from more-privileged software to less-privileged software are not allowed, so this privilege check fails as well.

Although both privilege checks fail, only one such failure is required to deny access to the interrupt handler.

8.7.5 Returning From Interrupt Procedures

A return to an interrupted program should be performed using the IRET instruction. An IRET is a far return to a different code segment, with or without a change in privilege level. The actions of an IRET in both cases are described in the following sections.

IRET, Same Privilege. Before performing the IRET, the stack pointer must point to the return EIP. If there was an error code pushed onto the stack as a result of the exception or interrupt, that error code should have been popped off the stack earlier by the handler. The IRET reverses the actions of the interrupt mechanism:

1. Pops the return pointer off of the stack, loading both the CS register and EIP register (RIP[31:0]) with the saved values. The return code-segment RPL is read by the processor from the CS value stored on the stack to determine that an equal-privilege control transfer is occurring.
2. Pops the saved EFLAGS image off of the stack and into the EFLAGS register.
3. Transfers control to the return program at the target CS:EIP.

IRET, Less Privilege. If an IRET changes privilege levels, the return program must be at a lower privilege than the interrupt handler. The IRET in this case causes a stack switch to occur:

1. The return pointer is popped off of the stack, loading both the CS register and EIP register (RIP[31:0]) with the saved values. The return code-segment RPL is read by the processor from the CS value stored on the stack to determine that a lower-privilege control transfer is occurring.
2. The saved EFLAGS image is popped off of the stack and loaded into the EFLAGS register.
3. The return-program stack pointer is popped off of the stack, loading both the SS register and ESP register (RSP[31:0]) with the saved values.
4. Control is transferred to the return program at the target CS:EIP.

8.8 Virtual-8086 Mode Interrupt Control Transfers

This section describes interrupt control transfers as they relate to virtual-8086 mode. Virtual-8086 mode is not supported by long mode. Therefore, the control-transfer mechanism described here is not applicable to long mode.

When a software interrupt occurs (not external interrupts, INT1, or INT3) while the processor is running in virtual-8086 mode (EFLAGS.VM=1), the control transfer that occurs depends on three system controls:

- *EFLAGS.IOPL*—This field controls interrupt handling based on the CPL. See “I/O Privilege Level Field (IOPL) Field” on page 52 for more information on this field.
Setting $IOPL < 3$ redirects the interrupt to the general-protection exception (#GP) handler.
- *CR4.VME*—This bit enables virtual-mode extensions. See “Virtual-8086 Mode Extensions (VME) Bit” on page 47 for more information on this bit.
- *TSS Interrupt-Redirection Bitmap*—The TSS interrupt-redirection bitmap contains 256 bits, one for each possible $INTn$ vector (software interrupt). When $CR4.VME=1$, the bitmap is used by the processor to direct interrupts to the handler provided by the currently-running 8086 program (bitmap entry is 0), or to the protected-mode operating-system interrupt handler (bitmap entry is 1). See “Legacy Task-State Segment” on page 313 for information on the location of this field within the TSS.

If $IOPL < 3$, $CR4.VME=1$, and the corresponding interrupt redirection bitmap entry is 0, the processor uses the virtual-interrupt mechanism. See “Virtual Interrupts” on page 247 for more information on this mechanism.

Table 8-10 summarizes the actions of the above system controls on interrupts taken when the processor is running in virtual-8086 mode.

Table 8-10. Virtual-8086 Mode Interrupt Mechanisms

EFLAGS.IOPL	CR4.VME	TSS Interrupt Redirection Bitmap Entry	Interrupt Mechanism
0, 1, or 2	0	—	General-Protection Exception
	1	1	
	1	0	Virtual Interrupt
3	0	—	Protected-Mode Handler
	1	1	
	1	0	Virtual 8086 Handler

8.8.1 Protected-Mode Handler Control Transfer

Control transfers to protected-mode handlers from virtual-8086 mode differ from standard protected-mode transfers in several ways. The processor follows these steps in making the control transfer:

1. Reads the $CPL=0$ stack pointer (SS:ESP) from the TSS.
2. Pushes the GS, FS, DS, and ES selector registers onto the stack. Each push is padded with two bytes to form a doubleword.
3. Clears the GS, FS, DS, and ES selector registers to 0. This places a null selector in each of the four registers
4. Pushes the return stack pointer (old SS:ESP) onto the new stack. The SS value is padded with two bytes to form a doubleword.

5. Pushes the EFLAGS register onto the new stack.
6. Clears the following EFLAGS bits to 0: TF, NT, RF, and VM.
7. Handles EFLAGS.IF based on the gate-descriptor type:
 - If the gate descriptor is an interrupt gate, EFLAGS.IF is cleared to 0.
 - If the gate descriptor is a trap gate, EFLAGS.IF is not modified.
8. Pushes the return-address pointer (CS:EIP) onto the stack. The CS value is padded with two bytes to form a doubleword.
9. If the interrupt has an associated error code, pushes the error code onto the stack.
10. Loads the segment-selector field from the gate descriptor into the CS register, and loads the offset field from the gate descriptor into the EIP register.
11. Begins execution of the interrupt handler with the instruction referenced by the new CS:EIP.

Figure 8-11 shows the new stack after control is transferred to the interrupt handler with an error code.

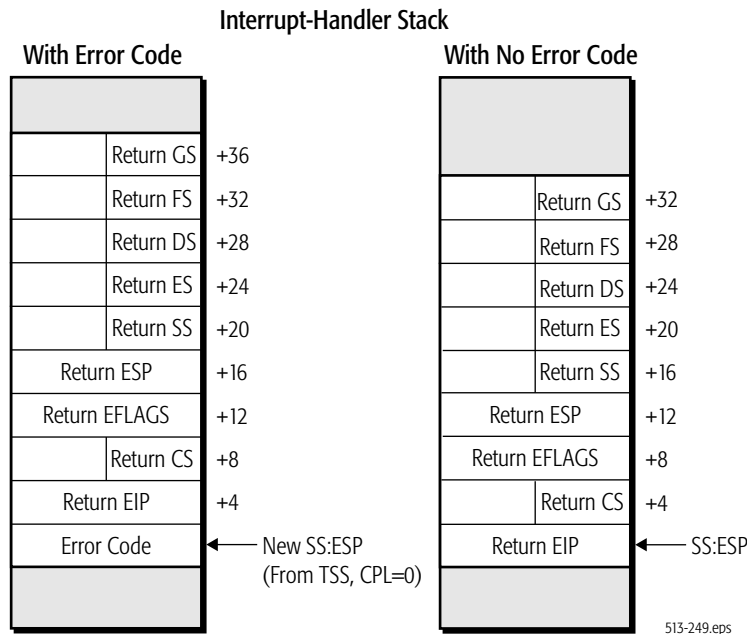

Figure 8-11. Stack After Virtual-8086 Mode Interrupt to Protected Mode

An IRET from privileged protected-mode software (CPL=0) to virtual-8086 mode reverses the stack-build process. After the return pointer, EFLAGS, and return stack-pointer are restored, the processor restores the ES, DS, FS, and GS registers by popping their values off the stack.

8.8.2 Virtual-8086 Handler Control Transfer

When a control transfer to an 8086 handler occurs from virtual-8086 mode, the processor creates an interrupt-handler stack identical to that created when an interrupt occurs in real mode (see Figure 8-6 on page 231). The processor performs the following actions during a control transfer:

1. Pushes the FLAGS register (EFLAGS[15:0]) onto the stack.
2. Clears the EFLAGS.IF and EFLAGS.RF bits to 0.
3. Saves the CS register and IP register (RIP[15:0]) by pushing them onto the stack.
4. Locates the interrupt-handler pointer (CS:IP) in the 8086 IDT by scaling the interrupt vector by four and adding the result to the virtual (linear) address 0. The value in the IDTR is not used.
5. Transfers control to the interrupt handler referenced by the CS:IP in the IDT.

An IRET from the 8086 handler back to virtual-8086 mode reverses the stack-build process.

8.9 Long-Mode Interrupt Control Transfers

The long-mode architecture expands the legacy interrupt-mechanism to support 64-bit operating systems and applications. These changes include:

- All interrupt handlers are 64-bit code and operate in 64-bit mode.
- The size of an interrupt-stack push is fixed at 64 bits (8 bytes).
- The interrupt-stack frame is aligned on a 16-byte boundary.
- The stack pointer, SS:RSP, is pushed unconditionally on interrupts, rather than conditionally based on a change in CPL.
- The SS selector register is loaded with a null selector as a result of an interrupt, if the CPL changes.
- The IRET instruction behavior changes, to unconditionally pop SS:RSP, allowing a null SS to be popped.
- A new interrupt stack-switch mechanism, called the interrupt-stack table or IST, is introduced.

8.9.1 Interrupt Gates and Trap Gates

Only long-mode interrupt and trap gates can be referenced in long mode (64-bit mode and compatibility mode). The legacy 32-bit interrupt-gate and 32-bit trap-gate types (0Eh and 0Fh, as described in “System Descriptors” on page 88) are redefined in long mode as 64-bit interrupt-gate and 64-bit trap-gate types. 32-bit and 16-bit interrupt-gate and trap-gate types do not exist in long mode, and software is prohibited from using task gates. If a reference is made to any gate other than a 64-bit interrupt gate or a 64-bit trap gate, a general-protection exception (#GP) occurs.

The long-mode gate types are 16 bytes (128 bits) long. They are an extension of the legacy-mode gate types, allowing a full 64-bit segment offset to be stored in the descriptor. See “Legacy Segment Descriptors” on page 77 for a detailed description of the gate-descriptor format and fields.

8.9.2 Locating the Interrupt Handler

When an interrupt occurs in long mode, the processor multiplies the interrupt-vector number by 16 and uses the result as an offset into the IDT. The gate descriptor referenced by the IDT offset contains a segment-selector and a 64-bit segment-offset field. The gate-descriptor segment-offset field contains the complete virtual address for the interrupt handler. The gate-descriptor segment-selector field points to the target code-segment descriptor located in either the GDT or LDT. The code-segment descriptor is only used for privilege-checking purposes and for placing the processor in 64-bit mode. The code-segment-descriptor base field, limit field, and most attributes are ignored.

Figure 8-12 shows how the long-mode interrupt handler is located by the interrupt mechanism.

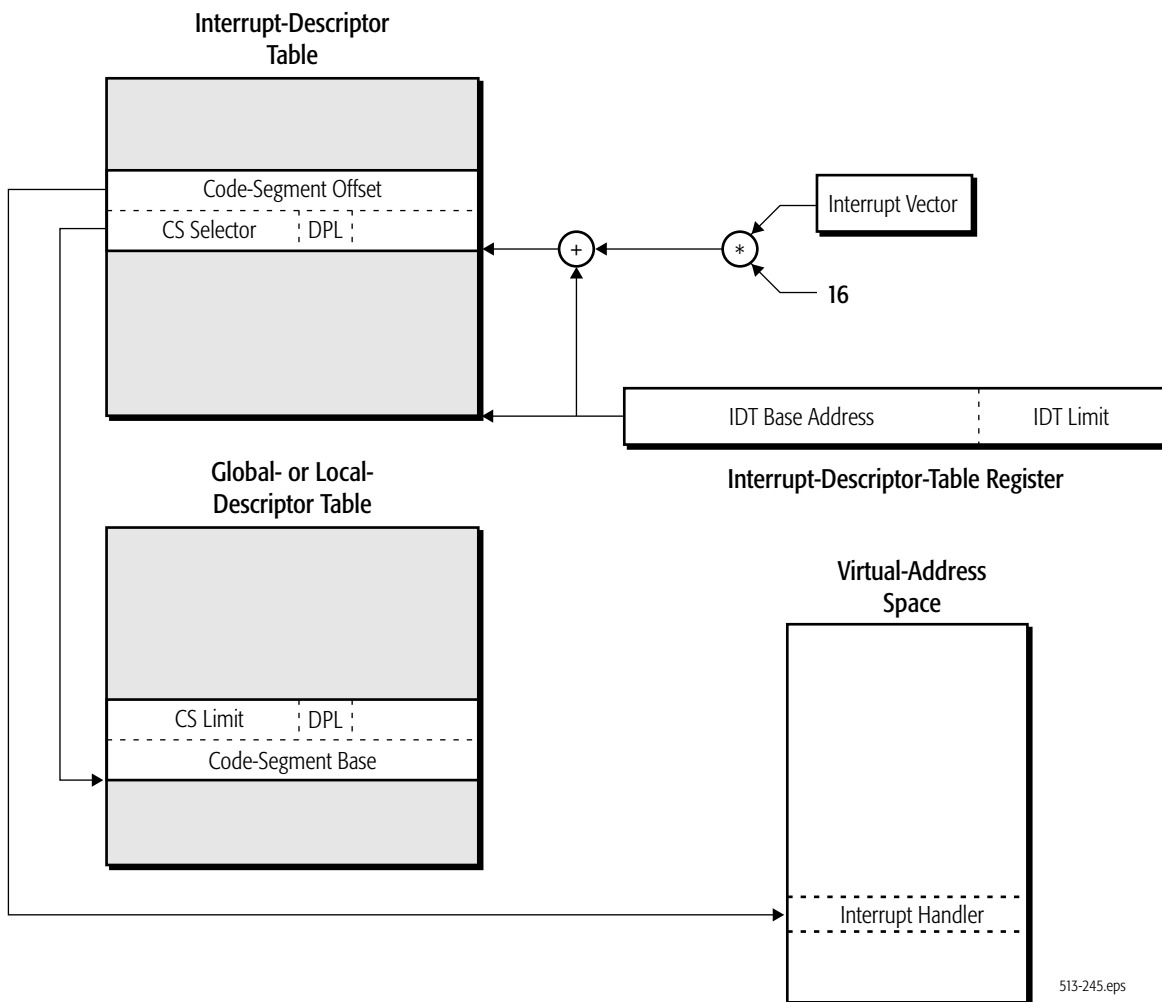

Figure 8-12. Long-Mode Interrupt Control Transfer

8.9.3 Interrupt Stack Frame

In long mode, the return-program stack pointer (SS:RSP) is always pushed onto the interrupt-handler stack, regardless of whether or not a privilege change occurs. Although the SS register is not used in 64-bit mode, SS is pushed to allow returns into compatibility mode. Pushing SS:RSP unconditionally presents operating systems with a consistent interrupt-stack-frame size for all interrupts, except for error codes. Interrupt service-routine entry points that handle interrupts generated by non-error-code interrupts can push an error code on the stack for consistency.

In long mode, when a control transfer to an interrupt handler occurs, the processor performs the following:

1. Aligns the new interrupt-stack frame by masking RSP with FFFF_FFFF_FFFF_FFF0h.
2. If IST field in interrupt gate is not 0, reads IST pointer into RSP.
3. If a privilege change occurs, the target DPL is used as an index into the long-mode TSS to select a new stack pointer (RSP).
4. If a privilege change occurs, SS is cleared to zero indicating a null selector.
5. Pushes the return stack pointer (old SS:RSP) onto the new stack. The SS value is padded with six bytes to form a quadword.
6. Pushes the 64-bit RFLAGS register onto the stack. The upper 32 bits of the RFLAGS image on the stack are written as zeros.
7. Clears the TF, NT, and RF bits in RFLAGS bits to 0.
8. Handles the RFLAGS.IF bit according to the gate-descriptor type:
 - If the gate descriptor is an interrupt gate, RFLAGS.IF is cleared to 0.
 - If the gate descriptor is a trap gate, RFLAGS.IF is not modified.
9. Pushes the return CS register and RIP register onto the stack. The CS value is padded with six bytes to form a quadword.
10. If the interrupt-vector number has an error code associated with it, pushes the error code onto the stack. The error code is padded with four bytes to form a quadword.
11. Loads the segment-selector field from the gate descriptor into the CS register. The processor checks that the target code-segment is a 64-bit mode code segment.
12. Loads the offset field from the gate descriptor into the target RIP. The interrupt handler begins execution when control is transferred to the instruction referenced by the new RIP.

Figure 8-13 on page 244 shows the stack after control is transferred to the interrupt handler.

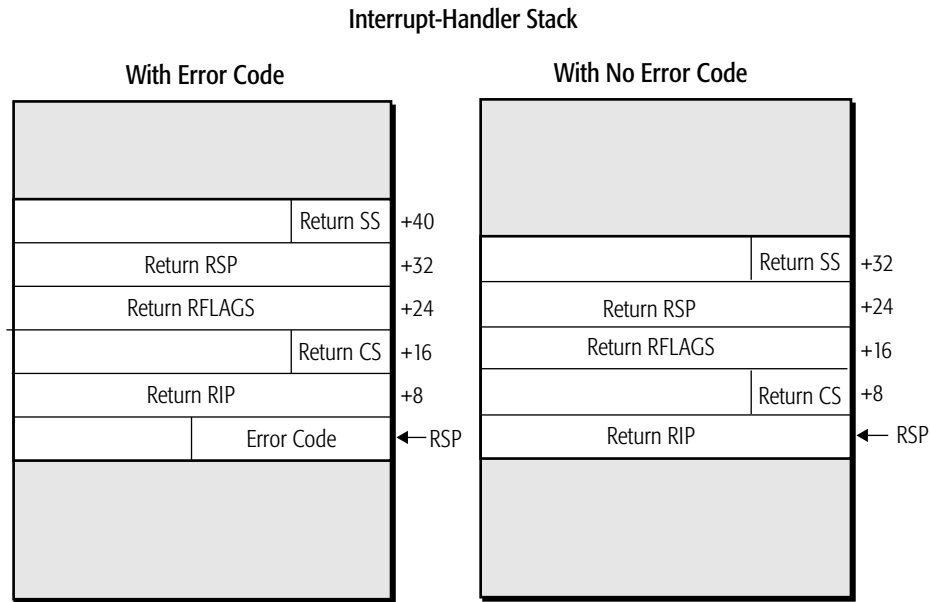

Figure 8-13. Long-Mode Stack After Interrupt—Same Privilege

Interrupt-Stack Alignment. In legacy mode, the interrupt-stack pointer can be aligned at any address boundary. Long mode, however, aligns the stack on a 16-byte boundary. This alignment is performed by the processor in hardware before pushing items onto the stack frame. The previous RSP is saved unconditionally on the new stack by the interrupt mechanism. A subsequent IRET instruction automatically restores the previous RSP.

Aligning the stack on a 16-byte boundary allows optimal performance for saving and restoring the 16-byte XMM registers. The interrupt handler can save and restore the XMM registers using the faster 16-byte aligned loads and stores (MOVAPS), rather than unaligned loads and stores (MOVUPS). Although the RSP alignment is always performed in long mode, it is only of consequence when the interrupted program is already running at CPL=0, and it is generally used only within the operating-system kernel. The operating system should put 16-byte aligned RSP values in the TSS for interrupts that change privilege levels.

Stack Switch. In long mode, the stack-switch mechanism differs slightly from the legacy stack-switch mechanism (see “Interrupt To Higher Privilege” on page 234). When stacks are switched during a long-mode privilege-level change resulting from an interrupt, a new SS descriptor is *not* loaded from the TSS. Long mode only loads an inner-level RSP from the TSS. However, the SS selector is loaded with a null selector, allowing nested control transfers, including interrupts, to be handled properly in 64-bit mode. The SS.RPL is set to the new CPL value. See “Nested IRETs to 64-Bit Mode Procedures” on page 247 for additional information.

The interrupt-handler stack that results from a privilege change in long mode looks identical to a long-mode stack when no privilege change occurs. Figure 8-14 shows the stack after the switch is performed and control is transferred to the interrupt handler.

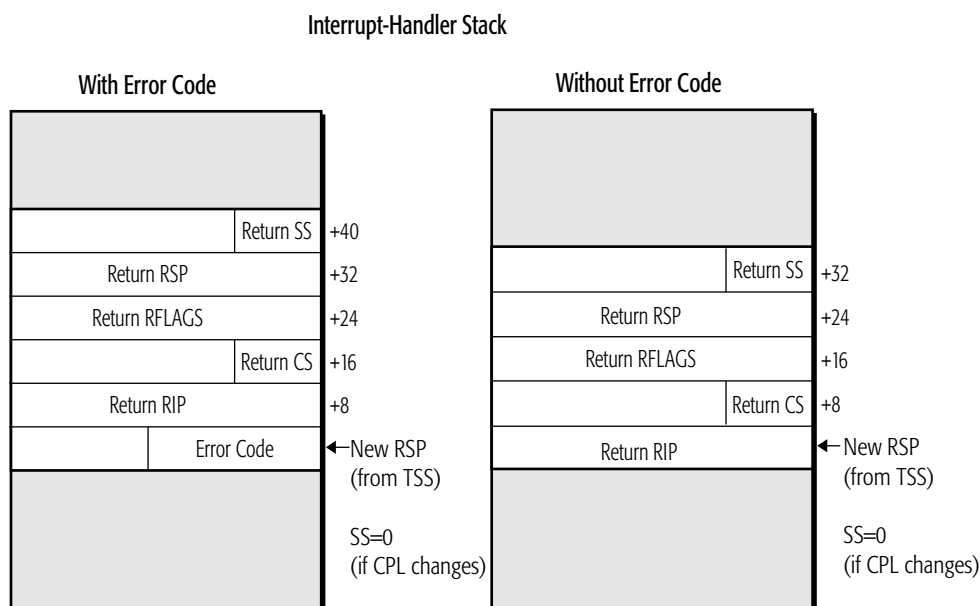

Figure 8-14. Long-Mode Stack After Interrupt—Higher Privilege

8.9.4 Interrupt-Stack Table

In long mode, a new interrupt-stack table (IST) mechanism is introduced as an alternative to the modified legacy stack-switch mechanism described above. The IST mechanism provides a method for specific interrupts, such as NMI, double-fault, and machine-check, to always execute on a known-good stack. In legacy mode, interrupts can use the hardware task-switch mechanism to set up a known-good stack by accessing the interrupt service routine through a task gate located in the IDT. However, the hardware task-switch mechanism is not supported in long mode.

When enabled, the IST mechanism unconditionally switches stacks. It can be enabled on an individual interrupt-vector basis using a new field in the IDT gate-descriptor entry. This allows some interrupts to use the modified legacy mechanism, and others to use the IST mechanism. The IST mechanism is only available in long mode.

The IST mechanism uses new fields in the 64-bit TSS format and the long-mode interrupt-gate and trap-gate descriptors:

- Figure 12-8 on page 319 shows the format of the 64-bit TSS and the location of the seven IST pointers. The 64-bit TSS offsets from 24h to 5Bh provide space for seven IST pointers, each of which are 64 bits (8 bytes) long.

- The long-mode interrupt-gate and trap-gate descriptors define a 3-bit IST-index field in bits 2–0 of byte +4. Figure 4-24 on page 91 shows the format of long-mode interrupt-gate and trap-gate descriptors and the location of the IST-index field.

To enable the IST mechanism for a specific interrupt, system software stores a non-zero value in the interrupt gate-descriptor IST-index field. If the IST index is zero, the modified legacy stack-switching mechanism (described in the previous section) is used.

Figure 8-15 shows how the IST mechanism is used to create the interrupt-handler stack. When an interrupt occurs and the IST index is non-zero, the processor uses the index to select the corresponding IST pointer from the TSS. The IST pointer is loaded into the RSP to establish a new stack for the interrupt handler. The SS register is loaded with a null selector if the CPL changes and the SS.RPL is set to the new CPL value. After the stack is loaded, the processor pushes the old stack pointer, RFLAGS, the return pointer, and the error code (if applicable) onto the stack. Control is then transferred to the interrupt handler.

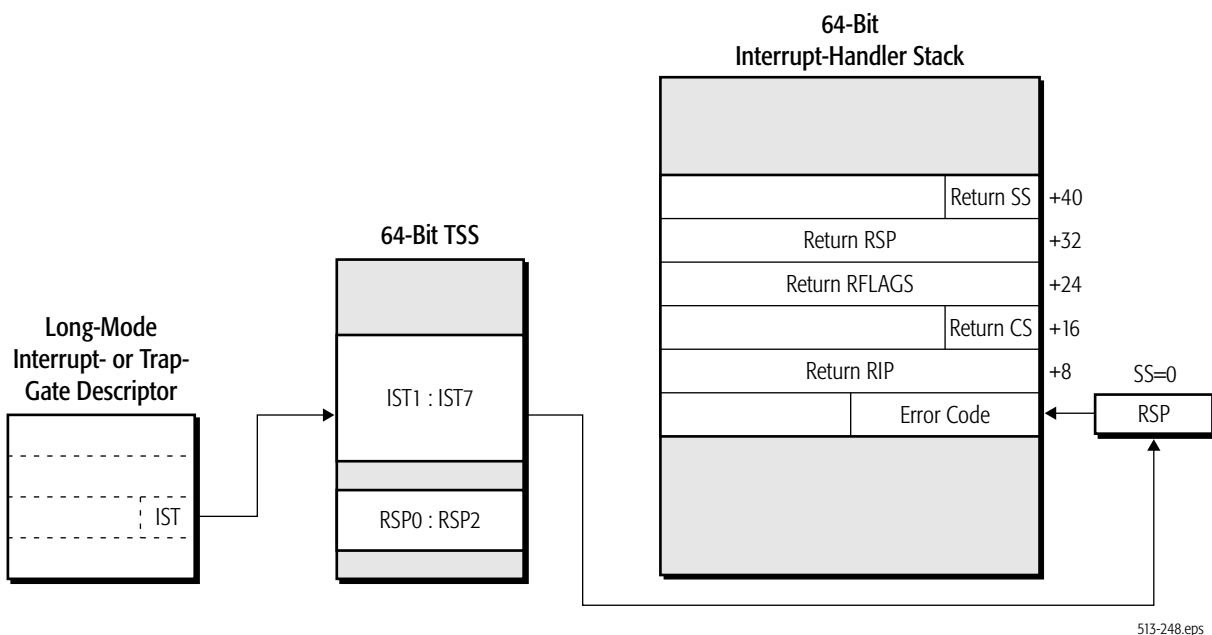

Figure 8-15. Long-Mode IST Mechanism

8.9.5 Returning From Interrupt Procedures

As with legacy mode, a return to an interrupted program in long mode should be performed using the IRET instruction. However, in long mode, the IRET semantics are different from legacy mode:

- In 64-bit mode, IRET pops the return-stack pointer unconditionally off the interrupt-stack frame and into the SS:RSP registers. This reverses the action of the long-mode interrupt mechanism,

which saves the stack pointer whether or not a privilege change occurs. IRET also allows a null selector to be popped off the stack and into the SS register. See “Nested IRETs to 64-Bit Mode Procedures” on page 247 for additional information.

- *In compatibility mode*, IRET behaves as it does in legacy mode. The SS:ESP is popped off the stack only if a control transfer to less privilege (numerically greater CPL) is performed. Otherwise, it is assumed that a stack pointer is not present on the interrupt-handler stack.

The long-mode interrupt mechanism always uses a 64-bit stack when saving values for the interrupt handler, and the interrupt handler is always entered in 64-bit mode. To work properly, an IRET used to exit the 64-bit mode interrupt-handler requires a series of eight-byte pops off the stack. This is accomplished by using a 64-bit operand-size prefix with the IRET instruction. The default stack size assumed by an IRET in 64-bit mode is 32 bits, so a 64-bit REX prefix is needed by 64-bit mode interrupt handlers.

Nested IRETs to 64-Bit Mode Procedures. In long mode, an interrupt causes a null selector to be loaded into the SS register if the CPL changes (this is the same action taken by a far CALL in long mode). If the interrupt handler performs a far call, or is itself interrupted, the null SS selector is pushed onto the stack frame, and another null selector is loaded into the SS register. Using a null selector in this way allows the processor to properly handle returns nested within 64-bit-mode procedures and interrupt handlers.

The null selector enables the processor to properly handle nested returns to 64-bit mode (which do not use the SS register), and returns to compatibility mode (which do use the SS register). Normally, an IRET that pops a null selector into the SS register causes a general-protection exception (#GP) to occur. However, in long mode, the null selector indicates the existence of nested interrupt handlers and/or privileged software in 64-bit mode. Long mode allows an IRET to pop a null selector into SS from the stack under the following conditions:

- The target mode is 64-bit mode.
- The target $CPL < 3$.

In this case, the processor does not load an SS descriptor, and the null selector is loaded into SS without causing a #GP exception.

8.10 Virtual Interrupts

The term *virtual interrupts* includes two classes of extensions to the interrupt-handling mechanism:

- *Virtual-8086 Mode Extensions (VME)*—These allow virtual interrupts and interrupt redirection in virtual-8086 mode. VME has no effect on protected-mode programs.
- *Protected-Mode Virtual Interrupts (PVI)*—These allow virtual interrupts in protected mode when $CPL=3$. Interrupt redirection is not available in protected mode. PVI has no effect on virtual-8086-mode programs.

Because virtual-8086 mode is not supported in long mode, VME extensions are not supported in long mode. PVI extensions are, however, supported in long mode.

8.10.1 Virtual-8086 Mode Extensions

The virtual-8086-mode extensions (VME) enable performance enhancements for 8086 programs running as protected tasks in virtual-8086 mode. These extensions are enabled by setting CR4.VME (bit 0) to 1. The extensions enabled by CR4.VME are:

- Virtualizing control and notification of maskable external interrupts with the EFLAGS VIF (bit 19) and VIP (bit 20) bits.
- Selective interception of software interrupts (INT n instructions) using the TSS interrupt redirection bitmap (IRB).

Background. Legacy-8086 programs expect to have full access to the EFLAGS interrupt flag (IF) bit, allowing programs to enable and disable maskable external interrupts. When those programs run in virtual-8086 mode under a multitasking protected-mode environment, it can disrupt the operating system if programs enable or disable interrupts for their own purposes. This is particularly true if interrupts associated with one program can occur during execution of another program. For example, a program could request that an area of memory be copied to disk. System software could suspend the program before external hardware uses an interrupt to acknowledge that the block has been copied. System software could subsequently start a second program which enables interrupts. This second program could receive the external interrupt indicating that the memory block of the first program has been copied. If that were to happen, the second program would probably be unprepared to handle the interrupt properly.

Access to the IF bit must be managed by system software on a task-by-task basis to prevent corruption of system resources. In order to completely manage the IF bit, system software must be able to interrupt all instructions that can read or write the bit. These instructions include STI, CLI, PUSHF, POPF, INT n , and IRET. These instructions are part of an instruction class that is *IOPL-sensitive*. The processor takes a general-protection exception (#GP) whenever an IOPL-sensitive instruction is executed and the EFLAGS.IOPL field is less than the CPL. Because all virtual-8086 programs run at CPL=3, system software can interrupt all instructions that modify the IF bit by setting IOPL<3.

System software maintains a virtual image of the IF bit for each virtual-8086 program by emulating the actions of IOPL-sensitive instructions that modify the IF bit. When an external maskable-interrupt occurs, system software checks the state of the IF image for the current virtual-8086 program to determine whether the program is masking interrupts. If the program is masking interrupts, system software saves the interrupt information until the virtual-8086 program attempts to re-enable interrupts. When the virtual-8086 program unmask interrupts with an IOPL-sensitive instruction, system software traps the action with the #GP handler.

The performance of a processor can be significantly degraded by the overhead of trapping and emulating IOPL-sensitive instructions, and the overhead of maintaining images of the IF bit for each virtual-8086 program. This performance loss can be eliminated by running virtual-8086 programs with IOPL set to 3, thus allowing changes to the real IF flag from any privilege level. Unfortunately, this can leave critical system resources unprotected.

In addition to the performance problems caused by virtualizing the IF bit, software interrupts (INT n instructions) cannot be masked by the IF bit or virtual copies of the IF bit. The IF bit only affects maskable external interrupts. Software interrupts in virtual-8086 mode are normally directed to the real mode interrupt-vector table (IVT), but it can be desirable to redirect certain interrupts to the protected-mode interrupt-descriptor table (IDT).

The virtual-8086-mode extensions are designed to support both external interrupts and software interrupts, with mechanisms that preserve high performance without compromising protection. Virtualization of external interrupts is supported using two bits in the EFLAGS register: the virtual-interrupt flag (VIF) bit and the virtual-interrupt pending (VIP) bit. Redirection of software interrupts is supported using the interrupt-redirection bitmap (IRB) in the TSS. A separate TSS can be created for each virtual-8086 program, allowing system software to control interrupt redirection independently for each virtual-8086 program.

VIF and VIP Extensions for External Interrupts. When VME extensions are enabled, the IF-modifying instructions normally trapped by system software are allowed to execute. However, instead of modifying the IF bit, they modify the EFLAGS VIF bit. This leaves control over maskable interrupts to the system software. It can also be used as an indicator to system software that the virtual-8086 program is able to, or is expecting to, receive external interrupts.

When an unmasked external interrupt occurs, the processor transfers control from the virtual-8086 program to a protected-mode interrupt handler. If the interrupt handler determines that the interrupt is for the virtual-8086 program, it can check the state of the VIF bit in the EFLAGS value pushed on the stack for the virtual-8086 program. If the VIF bit is set (indicating the virtual-8086 program attempted to unmask interrupts), system software can allow the interrupt to be handled by the appropriate virtual-8086 interrupt handler.

If the VIF bit is clear (indicating the virtual-8086 program attempted to mask interrupts) and the interrupt is for the virtual-8086 program, system software can hold the interrupt pending. System software holds an interrupt pending by saving appropriate information about the interrupt, such as the interrupt vector, and setting the virtual-8086 program's VIP bit in the EFLAGS image on the stack. When the virtual-8086 program later attempts to set IF, the previously set VIP bit causes a general-protection exception (#GP) to occur. System software can then pass the saved interrupt information to the virtual-8086 interrupt handler.

To summarize, when the VME extensions are enabled (CR4.VME=1), the VIF and VIP bits are set and cleared as follows:

- *VIF Bit*—This bit is set and cleared by the processor in virtual-8086 mode in response to an attempt by a virtual-8086 program to set and clear the EFLAGS.IF bit. VIF is used by system software to determine whether a maskable external interrupt should be passed on to the virtual-8086 program, emulated by system software, or held pending. VIF is also cleared during software interrupts through interrupt gates, with the original VIF value preserved in the EFLAGS image on the stack.
- *VIP Bit*—System software sets and clears this bit in the EFLAGS image saved on the stack after an interrupt. It can be set when an interrupt occurs for a virtual-8086 program that has a clear VIF bit.

The processor examines the VIP bit when an attempt is made by the virtual-8086 program to set the IF bit. If VIP is set when the program attempts to set IF, a general-protection exception (#GP) occurs *before* execution of the IF-setting instruction. System software must clear VIP to avoid repeated #GP exceptions when returning to the interrupted instruction.

The VIF and VIP bits can be used by system software to minimize the overhead associated with managing maskable external interrupts because virtual copies of the IF flag do not have to be maintained by system software. Instead, VIF and VIP are maintained during context switches along with the remaining EFLAGS bits.

Table 8-11 on page 252 shows how the behavior of instructions that modify the IF bit are affected by the VME extensions.

Interrupt Redirection of Software Interrupts. In virtual-8086 mode, software interrupts (INT n instructions) are trapped using a #GP exception handler if the IOPL is less than 3 (the CPL for virtual-8086 mode). This allows system software to interrupt and emulate 8086-interrupt handlers. System software can set the IOPL to 3, in which case the INT n instruction is vectored through a gate descriptor in the protected-mode IDT. System software can use the gate to control access to the virtual-8086 mode interrupt-vector table (IVT), or to redirect the interrupt to a protected-mode interrupt handler.

When VME extensions are enabled, for INT n instructions to execute normally, vectoring directly to a virtual-8086 interrupt handler through the virtual-8086 IVT (located at address 0 in the virtual-address space of the task). For security or performance reasons, however, it can be necessary to intercept INT n instructions on a vector-specific basis to allow servicing by protected-mode interrupt handlers. This is performed by using the interrupt-redirection bitmap (IRB), located in the TSS and enabled when CR4.VME=1. The IRB is available only in virtual-8086 mode.

Figure 12-6 on page 314 shows the format of the TSS, with the interrupt redirection bitmap located near the top. The IRB contains 256 bits, one for each possible software-interrupt vector. The most-significant bit of the IRB controls interrupt vector 255, and is located immediately before the IOPB base. The least-significant bit of the IRB controls interrupt vector 0.

The bits in the IRB function as follows:

- When set to 1, the INT n instruction behaves as if the VME extensions are not enabled. The interrupt is directed through the IDT to a protected-mode interrupt handler if IOPL=3. If IOPL<3, the INT n causes a #GP exception.
- When cleared to 0, the INT n instruction is directed through the IVT for the virtual-8086 program to the corresponding virtual-8086 interrupt handler.

Only software interrupts can be redirected using the IRB mechanism. External interrupts are asynchronous events that occur outside the context of a virtual-8086 program. Therefore, external interrupts require system-software intervention to determine the appropriate context for the interrupt. The VME extensions described in “VIF and VIP Extensions for External Interrupts” on page 249 are provided to assist system software with external-interrupt intervention.

8.10.2 Protected Mode Virtual Interrupts

The protected-mode virtual-interrupt (PVI) bit in CR4 enables support for interrupt virtualization in protected mode. When enabled, the processor maintains program-specific VIF and VIP bits similar to the manner defined by the virtual-8086 mode extensions (VME). However, unlike VME, only the STI and CLI instructions are affected by the PVI extension. When a program is running at CPL=3, it can use STI and CLI to set and clear its copy of the VIF flag without causing a general-protection exception. The last section of Table 8-11 on page 252 describes the behavior of instructions that modify the IF bit when PVI extensions are enabled.

The interrupt redirection bitmap (IRB) defined by the VME extensions is not supported by the PVI extensions.

8.10.3 Effect of Instructions that Modify EFLAGS.IF

Table 8-11 on page 252 shows how the behavior of instructions that modify the IF bit are affected by the VME and PVI extensions. The table columns specify the following:

- *Operating Mode*—the processor mode in effect when the instruction is executed.
- *Instruction*—the IF-modifying instruction.
- *IOPL*—the value of the EFLAGS.IOPL field.
- *VIP*—the value of the EFLAGS.VIP bit.
- *#GP*—indicates whether the conditions in the first four columns cause a general-protection exception (#GP) to occur.
- *Effect on IF Bit*—indicates the effect the conditions in the first four columns have on the EFLAGS.IF bit and the image of EFLAGS.IF on the stack.
- *Effect on VIF Bit*—indicates the effect the conditions in the first four columns have on the EFLAGS.VIF bit and the image of EFLAGS.VIF on the stack.

Table 8-11. Effect of Instructions that Modify the IF Bit

Operating Mode	Instruction	IOPL	VIP	#GP	Effect on IF Bit	Effect on VIF Bit
Real Mode <i>CR0.PE=0</i> <i>EFLAGS.VM=0</i> <i>CR4.VME=0</i> <i>CR4.PVI=0</i>	CLI			no	IF = 0	
	STI				IF = 1	
	PUSHF				EFLAGS.IF Stack Image = IF	
	POPF				IF = EFLAGS.IF stack image	
	INT _n				EFLAGS.IF Stack Image = IF IF = 0	
	IRET				IF = EFLAGS.IF Stack Image	
Protected Mode <i>CR0.PE=1</i> <i>EFLAGS.VM=0</i> <i>CR4.VME=x</i> <i>CR4.PVI=0</i>	CLI	≥CPL		no	IF = 0	
		<CPL		yes	—	
	STI	≥CPL		no	IF = 1	
		<CPL		yes	—	
	PUSHF	x	no	EFLAGS.IF Stack Image = IF		
	POPF	≥CPL		IF = EFLAGS.IF Stack Image		
		<CPL		No Change		
		INT _n gate		EFLAGS.IF Stack Image = IF IF = 0		
	IRET	x		IF = EFLAGS.IF Stack Image		
	IRETD					
Virtual-8086 Mode <i>CR0.PE=1</i> <i>EFLAGS.VM=1</i> <i>CR4.VME=0</i> <i>CR4.PVI=x</i>	CLI	3		no	IF = 0	
		< 3		yes	—	
	STI	3		no	IF = 1	
		< 3		yes	—	
	PUSHF	3		no	EFLAGS.IF Stack Image = IF	
		< 3		yes	—	
	POPF	3		no	IF = EFLAGS.IF Stack Image	
		< 3		yes	—	
	INT _n gate	3		no	EFLAGS.IF Stack Image = IF IF = 0	
		< 3		yes	—	
	IRET	3		no	IF = EFLAGS.IF Stack Image	
		< 3		yes	—	
	IRETD	3		no	IF = EFLAGS.IF Stack Image	
		< 3		yes	—	

Note:

Gray-shaded boxes indicate the bits are unsupported (ignored) in the specified operating mode.
 “x” indicates the value of the bit is a “don’t care”.
 “—” indicates the instruction causes a general-protection exception (#GP).

Note:

1. If the EFLAGS.IF stack image is 0, no #GP exception occurs and the IRET instruction is executed.
2. If the EFLAGS.IF stack image is 1, the IRET is not executed, and a #GP exception occurs.

Table 8-11. Effect of Instructions that Modify the IF Bit (continued)

Operating Mode	Instruction	IOPL	VIP	#GP	Effect on IF Bit	Effect on VIF Bit
Virtual-8086 Mode with VME Extensions <i>CR0.PE=1</i> <i>EFLAGS.VM=1</i> <i>CR4.VME=1</i> <i>CR4.PVI=x</i>	CLI	3	x	no	IF = 0	No Change
		<3			No Change	VIF = 0
	STI	3	x	no	IF = 1	No Change
		<3	0	no	No Change	VIF = 1
			1	yes	—	
	PUSHF	3	x	no	EFLAGS.IF Stack Image = IF	Not Pushed
		<3			Not Pushed	EFLAGS.IF Stack Image = VIF
	PUSHFD	3	x	no	EFLAGS.IF Stack Image = IF	EFLAGS.VIF Stack Image = VIF
		<3		yes	—	
	POPF	3	x	no	IF = EFLAGS.IF Stack Image	No Change
		<3	0	no	No Change	VIF = EFLAGS.IF Stack Image
			1	yes	—	
	POPFD	3	x	no	IF = EFLAGS.IF Stack Image	No Change
		<3		yes	—	
	INT n gate	3	x	no	EFLAGS.IF Stack Image = IF IF = 0	No Change
		<3			No Change	EFLAGS.IF Stack Image = VIF VIF = 0
	IRET	3	x	no	IF = EFLAGS.IF Stack Image	No Change
		<3	0	no	No Change	VIF = EFLAGS.IF Stack Image
1			no ¹	No Change	VIF = EFLAGS.IF Stack Image	
		yes ²	—			
IRETD	3	x	no	IF = EFLAGS.IF Stack Image	VIF = EFLAGS.IF Stack Image	
	<3		yes	—		

Note:

Gray-shaded boxes indicate the bits are unsupported (ignored) in the specified operating mode.

"x" indicates the value of the bit is a "don't care".

"—" indicates the instruction causes a general-protection exception (#GP).

Note:

1. If the EFLAGS.IF stack image is 0, no #GP exception occurs and the IRET instruction is executed.

2. If the EFLAGS.IF stack image is 1, the IRET is not executed, and a #GP exception occurs.

Table 8-11. Effect of Instructions that Modify the IF Bit (continued)

Operating Mode	Instruction	IOPL	VIP	#GP	Effect on IF Bit	Effect on VIF Bit
Protected Mode with PVI Extensions <i>CR0.PE=1</i> <i>EFLAGS.VM=0</i> <i>CR4.VME=x</i> <i>CR4.PVI=1</i> <i>CPL=3</i>	CLI	3	x	no	IF = 0	No Change
		<3			No Change	VIF = 0
	STI	3	x	no	IF = 1	No Change
		<3	0	no	No Change	VIF = 1
			1	yes	—	
	PUSHF	x	x	no	EFLAGS.IF Stack Image = IF	Not Pushed
	PUSHFD					EFLAGS.VIF Stack Image = VIF
	POPF				IF = EFLAGS.IF Stack Image	No Change
	POPFD					VIF = 0
	INT n gate				EFLAGS.IF Stack Image = IF IF = 0 (if interrupt gate)	No Change
	IRET				IF = EFLAGS.IF Stack Image	No Change
IRETD	VIF = EFLAGS.VIF Stack Image					

Note:

Gray-shaded boxes indicate the bits are unsupported (ignored) in the specified operating mode.
 “x” indicates the value of the bit is a “don’t care”.
 “—” indicates the instruction causes a general-protection exception (#GP).

Note:

1. If the EFLAGS.IF stack image is 0, no #GP exception occurs and the IRET instruction is executed.
2. If the EFLAGS.IF stack image is 1, the IRET is not executed, and a #GP exception occurs.

9 Machine Check Mechanism

The machine-check mechanism allows the processor to detect and report a variety of hardware errors. The types of errors that can be reported include:

- Cache errors associated with reading and writing data, probing, cache-line fills, and cache-line writebacks.
- Parity errors associated with the caches and TLBs.
- ECC errors associated with the caches and DRAM.
- Bus errors associated with reading and writing on the processor external bus.

Software can enable the processor to report machine-check errors through the machine-check exception (for additional information, see “#MC—Machine-Check Exception (Vector 18)” on page 222). Most machine-check error conditions do not allow reliable restarting of interrupted programs. System software instead uses the machine-check mechanism to report the source of hardware problems for possible servicing.

The basic machine-check mechanism is consistent across processor implementations, but the error-reporting registers are model specific. Processor implementations are not required to support the mechanism, and those implementations that do support it can vary in how the mechanism works.

9.1 Determining Machine-Check Support

The availability of machine-check registers and support of the machine-check exception is implementation dependent. System software executes the CPUID instruction to determine whether a processor implements these features. After CPUID is executed, the values of the machine-check architecture (MCA) bit and the machine-check exception (MCE) bit loaded in the EDX register indicate whether the processor implements the machine-check registers and the machine-check exception, respectively. See “Processor Feature Identification” on page 61 for more information on using the CPUID instruction to determine the level of machine-check support.

Once system software determines that the machine-check registers are available, it must determine the extent of processor support for the machine-check mechanism. This is accomplished by reading the machine-check capabilities register (MCG_CAP). See “Machine-Check Global-Capabilities Register” on page 257 for more information on interpreting the MCG_CAP contents.

Implementation-specific information concerning the machine-check mechanism can be found in the BIOS writer’s guide for the implementation.

9.2 Machine-Check Errors

The following classes of machine-check errors are defined for the AMD64 architecture:

- *Recoverable*—The error has been corrected by the processor. Recoverable errors do not cause a machine check exception (#MC). However, the error is still logged in the machine-check registers. It is the responsibility of system software to periodically poll the machine-check registers to determine whether recoverable errors have occurred.
- *Fatal/Unrecoverable*—The error cannot be corrected by the processor. Unrecoverable errors cause a machine check exception if CR4.MCE is set to 1.

In both cases, the contents of the machine-check registers are maintained through a warm reset, which allows errors to be reported even if a reset occurs.

9.2.1 Error Sources

Implementations can detect errors from any number of sources located within the various processor units. Those processor units can include the following:

- *Data-Cache Unit (DC)*—Includes the cache structures that hold data and tags, the data TLBs, and cache-probing logic.
- *Instruction-Cache Unit (IC)*—Includes the cache structures that hold instructions and tags, the instruction TLBs, and cache-probing logic.
- *Bus Unit (BU)*—Includes the L2 cache and any external caches.
- *Load/Store Unit (LS)*—Includes logic used to manage loads and stores.
- *Northbridge (NB)*—Includes the system-bus interface and DRAM controller.

A given processor implementation can monitor machine-check errors in sources other than those listed above. The number is implementation-specific and is determined by examining the MCG_CAP register (see “Machine-Check Global-Capabilities Register” on page 257). For further information, see the documentation for particular implementations of the architecture.

9.3 Machine Check MSRs

The AMD64 architecture defines a set of model-specific registers (MSRs) in support of the machine-check mechanism. These registers include:

- Global-status and global-control registers:
 - Machine-check global-capabilities register (MCG_CAP).
 - Machine-check global-status register (MCG_STATUS).
 - Machine-check global-control register (MCG_CTL).
 - CPU watchdog timer register (CPU_WATCHDOG_TIMER)
- Error-reporting register banks, each containing:
 - Machine-check control register (MCi_CTL).
 - Machine-check status register (MCi_STATUS).
 - Machine-check address register (MCi_ADDR).

- Machine-check miscellaneous error-information register (MCI_MISCj).

Each error-reporting register bank is associated with a specific processor unit (or group of processor units).

- CPU Watchdog Timer register (CPU_WATCHDOG_TIMER)

In some cases, the machine-check handler cannot be invoked due to an error, the error-reporting registers retain their values through a warm reset. (A warm reset is a reset that occurs while the processor is powered up, as opposed to a cold reset, which occurs during power-up.) This allows the BIOS or other system-boot software to recover and report information associated with the error.

The RDMSR and WRMSR instructions are used to read and write the machine-check MSRs. See “Machine-Check MSRs” on page 466 for a listing of the machine-check MSR numbers and their reset values. The following sections describe each machine-check MSR and its function.

9.3.1 Global Status and Control Registers

The global-status and global-control MSRs supported by the machine-check mechanism include the MCG_CAP, MCG_STATUS, and MCG_CTL registers.

Machine-Check Global-Capabilities Register. Figure 9-1 shows the format of the machine-check global-capabilities register (MCG_CAP). MCG_CAP is a read-only register that specifies the machine-check mechanism capabilities supported by the processor implementation.

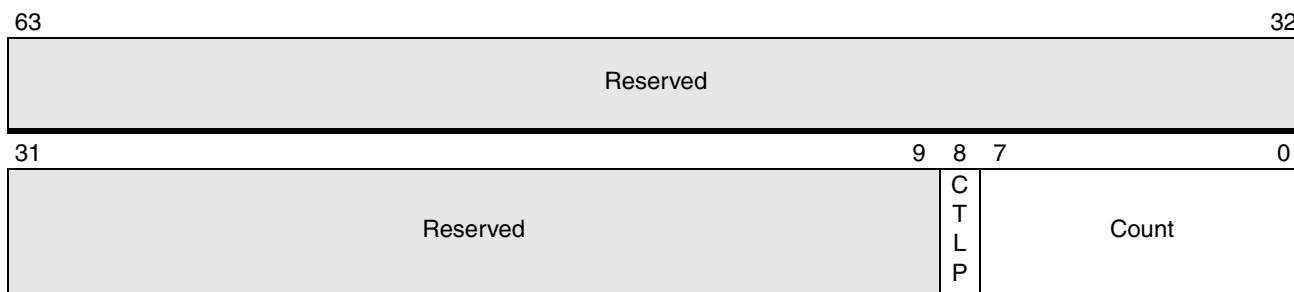

Bits	Mnemonic	Description	R/W
63–9	Reserved		
8	CTLP	MCG_CTL_PMCG_CTL register present	R
7-0	Count	Number of reporting banks	R

Figure 9-1. MCG_CAP Register

The fields within the MCG_CAP register are:

- *Count*—Bits 7–0. This field specifies how many error-reporting register banks are supported by the processor implementation.

- *MCG_CTL_PMCG_CTL Register Present (CTLP)*—Bit 8. This bit specifies whether or not the MCG_CTL_PMCG_CTL register is supported by the processor. When the bit is set to 1, the register is supported. When the bit is cleared to 0, the register is unsupported.

All remaining bits in the MCG_CAP register are reserved. Writing values to the MCG_CAP register produces undefined results.

Machine-Check Global-Status Register. Figure 9-2 shows the format of the machine-check global-status register (MCG_STATUS). MCG_STATUS provides basic information about the processor state after the occurrence of a machine-check error.

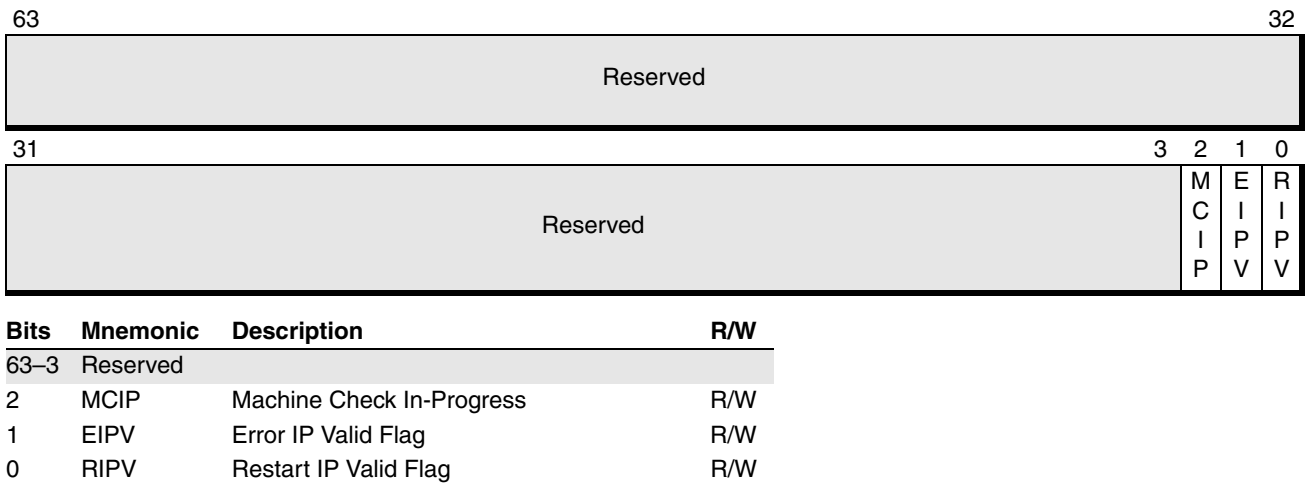

Figure 9-2. MCG_STATUS Register

The fields within the MCG_STATUS register are:

- *Restart-IP Valid (RIPV)*—Bit 0. When this bit is set to 1, the interrupted program can be reliably restarted at the instruction addressed by the instruction pointer pushed onto the stack by the machine-check error mechanism. If this bit is cleared to 0, the interrupted program cannot be reliably restarted.
- *Error-IP Valid (EIPV)*—Bit 1. When this bit is set to 1, the instruction that is referenced by the instruction pointer pushed onto the stack by the machine-check error mechanism is responsible for the machine-check error. If this bit is cleared to 0, it is possible that the instruction referenced by the instruction pointer is not responsible for the machine-check error.
- *Machine Check In-Progress (MCIP)*—Bit 2. When this bit is set to 1, it indicates that a machine-check error is in progress. If another machine-check error occurs while this bit is set, the processor enters the shutdown state. The processor sets this bit whenever a machine check exception is generated. Software is responsible for clearing it after the machine check exception is handled.

All remaining bits in the MCG_STATUS register are reserved.

Machine-Check Global-Control Register. Figure 9-3 shows the format of the machine-check global-control register (MCG_CTL). MCG_CTL is used by software to control reporting machine-check errors from various sources. Each error-reporting register bank supported by the processor is controlled by a corresponding enable bit in this register. Setting all bits to 1 in this register enables all error-reporting register banks. The number of controls and how they are used is implementation-specific (for further information, see the documentation for particular implementations of the architecture). The presence of the MCG_CTL register is indicated by the MCG_CAP register MCG_CTL_P bit, described on page 257.

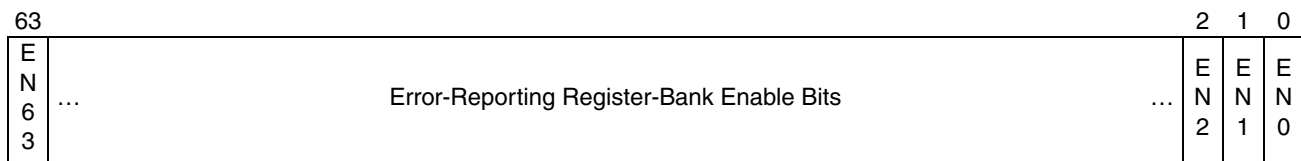
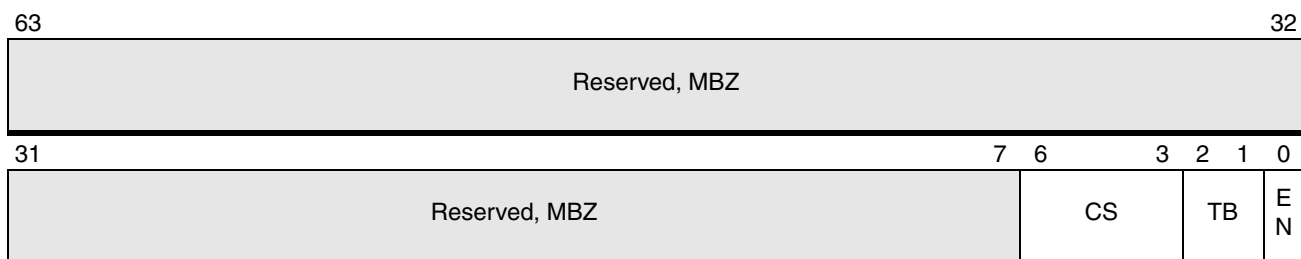

Figure 9-3. MCG_CTL Register

CPU Watchdog Timer Register. The CPU watchdog timer is used to generate a machine check condition when an instruction does not complete within a time period specified by the CPU Watchdog Timer register. The timer restarts the count each time an instruction completes, when enabled by the *CPU Watchdog Timer Enable* bit. The time period is determined by the *Count Select* and *Time Base* fields. The timer does not count during halt or stop-grant. The machine check condition is controlled by the appropriate MCI_CTL register.

The format of the CPU watchdog timer is shown in Figure 9-4.



Bits	Mnemonic	Description	R/W
63–7	Reserved	Reserved, Must be Zero	
6–3	CS	CPU Watchdog Timer Count Select	R/W
2–1	TB	CPU Watchdog Timer Time Base	R/W
0	EN	CPU Watchdog Timer Enable	R/W

Figure 9-4. CPU Watchdog Timer Register Format

CPU Watchdog Timer Enable (EN) - Bit 0. This bit specifies whether the CPU Watchdog Timer is enabled. When the bit is set to 1, the timer increments and generates a machine check when the timer expires. When cleared to 0, the timer does not increment and no machine check is generated.

CPU Watchdog Timer Time Base (TB) - Bits 2-1. Specifies the time base for the time-out period indicated in the *Count Select* field. The allowable time base values are provided in Table 9-1.

Table 9-1. CPU Watchdog Timer Time Base

Bits	Time Base
00b	1 millisecond
01b	1 microsecond
10b	5 nanoseconds
11b	Reserved

CPU Watchdog Timer Count Select (CS) - Bits 6-3. Specifies the time period required for the CPU Watchdog Timer to expire. The time period is this value times the time base specified in the *Time Base* field. The allowable values are shown in Table 9-2.

Table 9-2. CPU Watchdog Timer Count Select

Bits	Value
0000b	4095
0001b	2047
0010b	1023
0011b	511
0100b	255
0101b	127
0110b	63
0111b	31
1000b	8191
1001b	16383
1010b- 1111b	Reserved

9.3.2 Error-Reporting Register Banks

Error-reporting register banks contain the following registers:

- Machine-check control registers (*MCi_CTL*).
- Machine-check status register (*MCi_STATUS*).
- Machine-check address register (*MCi_ADDR*).
- Machine-check miscellaneous error-information register (*MCi_MISCj*).

The *i* in each register name corresponds to the number of a supported register bank. Each error-reporting register bank is associated with a specific processor unit (or group of processor units). The number of error-reporting register banks is implementation-specific. For more information, see the

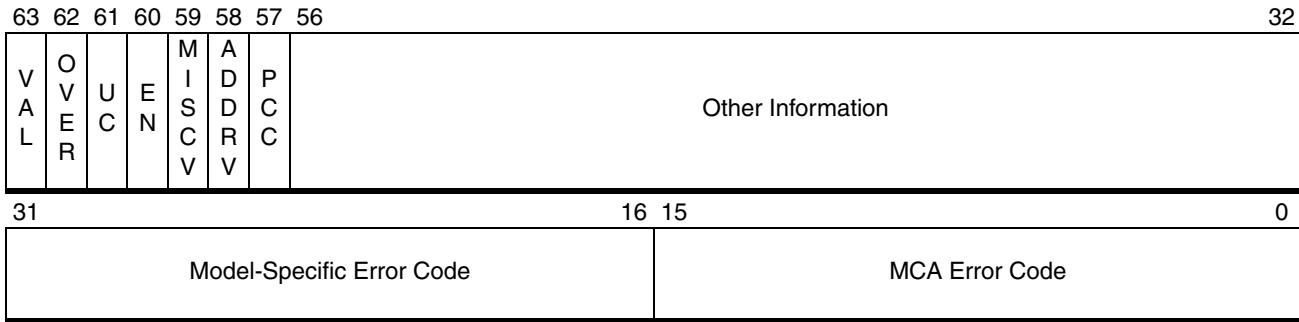

Bits	Mnemonic	Description	R/W
63	VAL	Valid	R/W*
62	OVER	Status Register Overflow	R/W*
61	UC	Uncorrected Error	R/W*
60	EN	Error Condition Enabled	R/W*
59	MISCV	Miscellaneous-Error Register Valid	R/W*
58	ADDRV	Error-Address Register Valid	R/W*
57	PCC	Processor-Context Corrupt	R/W*
56–32		Other Information	R/W*
31–16		Model-Specific Error Code	R/W*
15–0		MCA Error Code	R/W*

*Applications can only clear this bit to 0.

Figure 9-6. MCi_STATUS Register

9.3.3 Error Codes

When a machine-check error occurs, the processor loads an error code into the appropriate MCi_STATUS register MCA error-code field. The MCi_STATUS.VAL bit is set to 1, indicating that the MCi_STATUS register contents are valid. The machine-check mechanism also allows the processor to load a model-specific error code into the MCi_STATUS register.

MCA error-codes are used to report errors in the memory hierarchy, the system bus, and the system-interconnection logic. Error-codes are divided into subfields that are used to describe the cause of an error. The information is implementation specific. It includes the location in the memory hierarchy where the error occurred and the type of transaction that caused the error. For further information, see the documentation for particular implementations of the architecture.

The fields within the MCi_STATUS register are:

- *MCA Error Code*—Bits 15–0. This field encodes information about the error, including:
 - The type of transaction that caused the error.
 - The memory-hierarchy level involved in the error.
 - The type of request that caused the error.
 - Other information concerning the transaction type.

See the appropriate implementation specific BIOS and kernel developer's guide for information on the format and encoding of the MCA error code.

- *Model-Specific Error Code*—Bits 31–16. This field encodes model-specific information about the error. For further information, see the documentation for particular implementations of the architecture.
- *Other Information*—Bits 56–32. This field holds model-specific error information. Software should not rely on the field definitions being consistent between processor implementations. Presently, the bits in this field are defined as:
 - Bits 44–32—Reserved.
 - Bit 45—When set to 1, this bit indicates the error is an uncorrectable ECC error.
 - Bit 46—When set to 1, this bit indicates the error is a correctable ECC error.
 - Bits 54–47—This field holds the ECC syndrome when an ECC error occurs.
 - Bits 56–55—Reserved.
- *PCC*—Bit 57. When set to 1, this bit indicates that the processor state is likely to be corrupt due to the machine-check error. In this case, it is possible software cannot restart the processor reliably. When this bit is cleared to 0, the processor state is not corrupted by the machine-check error. If the PCC bit is set in any error bank, the processor will clear RIPV and EIPV in the MCG_Status register.
- *ADDRV*—Bit 58. When set to 1, this bit indicates that the address saved in the corresponding error-reporting address register (MCi_ADDR) is valid, and contains the address where the error was detected. When this bit is cleared to 0, MCi_ADDR does not contain a valid error address.
- *MISCV*—Bit 59. When set to 1, this bit indicates that additional information about the machine-check error is saved in the corresponding error-reporting miscellaneous register (MCi_MISC). This bit is cleared to 0 when the MCi_MISC registers are not implemented.
- *EN*—Bit 60. When set to 1, this bit indicates that the error condition is enabled in the corresponding error-reporting control register (MCi_CTL). Errors disabled by MCi_CTL do not cause a machine-check exception, but the machine-check mechanism can log errors when error reporting is disabled in MCi_CTL.
- *UC*—Bit 61. When set to 1, this bit indicates that the processor did not correct the error condition. When this bit is cleared to 0, the processor corrected the error condition.
- *OVER*—Bit 62. This bit is set to 1 by the processor if the VAL bit is already set to 1 as the processor attempts to load error information into MCi_STATUS. This indicates that the results of a previous machine-check error are still in the MCi_STATUS register. In this situation, the machine-check mechanism handles the contents of MCi_STATUS as follows:
 - Status for an enabled error replaces status for a disabled error.
 - Status for an uncorrectable error replaces status for a correctable error.
 - Status for an enabled uncorrectable error is never replaced.

- **VAL**—Bit 63. This bit is set to 1 by the processor if the contents of `MCi_STATUS` are valid. Software should clear the VAL bit after reading the `MCi_STATUS` register, otherwise a subsequent machine-check error sets the OVER bit as described above.

Machine-Check Address Registers. Each error-reporting register bank includes a machine-check address register (`MCi_ADDR`) that the processor uses to report the address associated with the machine-check error. The address field can hold either a virtual (linear) or physical address, depending on the type of error. For further information, see the documentation for particular implementations of the architecture. The contents of this register are valid only if the `ADDRV` bit in the corresponding `MCi_STATUS` register is set to 1.

Machine-Check Miscellaneous-Error Information Registers (`MCi_MISCj`). Each error-reporting register bank can include a machine-check miscellaneous (thresholding) register that the processor uses to report additional error information associated with error thresholding:

Error thresholding is a mechanism provided by hardware to:

- count machine check correctable errors
- (optionally) generate an APIC-based interrupt when a programmed number of correctable errors has been counted. Software can program the error count required to cause the interrupt.

Processor hardware counts correctable errors and ensures that multiple correctable error sources do not share the same thresholding register. Software can use this information to predict which components might soon fail due to uncorrectable errors and schedule their replacement. Whether other errors (uncorrectable or deferred) are also counted is implementation dependent.

Threshold counters increment for machine-check correctable errors that are conditioned to be “logged”. To enable error logging:

- machine checks must be globally enabled for the bank, and
- other implementation-specific mechanisms that allow logging of machine checks for the bank must be enabled. Logging is different from reporting, so reporting does not have to be enabled (`MCi_CTL[ErrorReportingEnable] = 0`) to increment the threshold counters.

There are two types of machine check miscellaneous error-information (thresholding) registers:

- `MCi_MISC0`—the first thresholding register in the bank. It has the following characteristics:
 - valid only if the `MISCV` bit in the corresponding `MCi_STATUS` register is set to 1.
 - located at the MSR address of the associated `MCi_CTL + 3`.
 - indicates the existence of additional thresholding registers for the bank when `MCi_MISC0[BlkPtr] > 0`.
- `MCi_MISCj` ($j > 0$)—Additional thresholding registers in the bank, with the following characteristics:
 - up to 8 additional `MCi_MISCj` registers can be supported per bank
 - thresholding registers reside in contiguous error MSR blocks, with `MCi_MISC1` addressed by:

$$MCi_MISC1 \text{ address} = C000_0400h + (MCi_MISC0[BlkPtr] \ll 3)$$

(See Figure 9-7 below.)

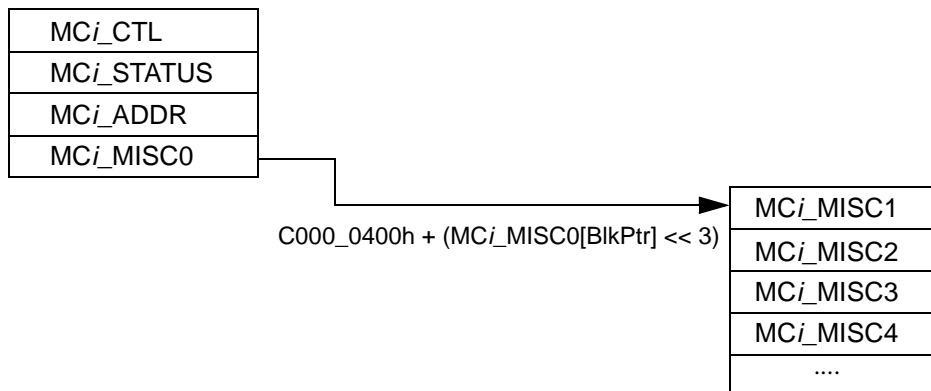
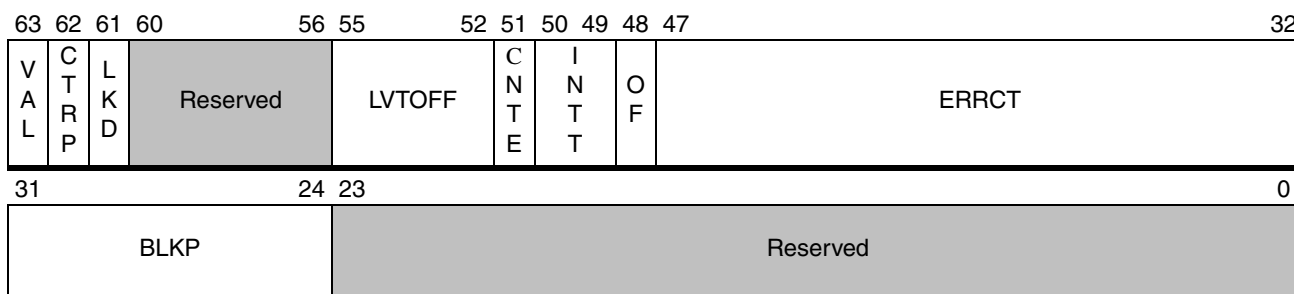

Figure 9-7. *MCi_MISC1* Addressing



Bits	Mnemonic	Description	R/W	Reset
63	VAL	Valid	R	1b
62	CTRP	Counter Present	R	1b
61	LKD	Locked	R/W	0b
60–56	Reserved			
55–52	LVTOFF	LVT Offset	R/W	0000b
51	CNTE	Counter Enable	R/W	0b
50–49	INTT	Interrupt Type	R/W	00b
48	OF	Overflow	R/W	Xb
47–32	ERRCT	Error Counter	R/W	XXXXh
31–24	BLKP	Block pointer for additional MISC registers	R	
23–0	Reserved			

Figure 9-8. Machine Check Miscellaneous Error-Information Register (*MCi_MISCj*)

The fields within the MCi_MISCj register are:

- *Valid (VAL)*—Bit 63. When set to 1, indicates that the counter present (CTRP) and block pointer (BLKP) fields in this register are valid.
- *Counter Present (CTRP)*—Bit 62. When set to 1, indicates the presence of a threshold counter.
- *Locked (LKD)*—Bit 61. When set to 1, indicates that the threshold counter is not available for OS use. If this is the case, writes to bits [60:0] of this register are ignored and do not generate a fault. Software must check the Locked bit before writing into the thresholding register.

This field is write-enabled by MSR C001_0015 Hardware Configuration Register [MCSTATUSWrEn].

- *LVT Offset (LVTOFF)*—Bits 55–52. This field specifies the address of the APIC LVT entry to deliver the threshold counter interrupt. Software must initialize the APIC LVT entry before enabling the threshold counter to generate the APIC interrupt; otherwise, undefined behavior may result.

APIC LVT address = $(MCi_MISC[LvtOff] \ll 4) + 500h$

- *Counter Enable (CNTE)*—Bit 51. When set to 1, counting of implementation-dependent errors is enabled; otherwise, counting is disabled.
- *Interrupt Type (INTT)*—Bits 50–49. The value of this field specifies the type of interrupt signaled when the value of the overflow bit changes from 0 to 1.
 - 00b = No interrupt
 - 01b = APIC-based interrupt
 - 10b = Reserved
 - 11b = Reserved

- *Overflow (OF)*—Bit 48. The value of this field is maintained through a warm reset. This bit is set by hardware when the error counter increments to its maximum implementation-supported value (from FFFEh to FFFFh for the maximum implementation-supported value). This is defined as the threshold level. When the overflow bit is set, the interrupt selected by the interrupt type field is generated. Software must reset this bit to zero in the interrupt handler routine when they update the error counter.

- *Error Counter (ERRCT)*—Bits 47–32. This field is maintained through a warm reset. The size of the threshold counter is implementation-dependent. Implementations with less than 16 bits fill the most significant unimplemented bits with zeros.

Software enumerates the counter bits to discover the size of the counter and the threshold level (when counter increments to the maximum count implemented). Software sets the starting error count as follows:

Starting error count = threshold level – desired software error count to cause overflow

The error counter is incremented by hardware when errors for the associated error counter are logged. When this counter overflows, it stays at the maximum error count (with no rollover).

- *Block pointer for additional MISC registers (BLKP)*—Bits 31–24. This field is only valid when valid (VAL) bit is set. When non-zero, this field is used to calculate a pointer to a contiguous MISC

MSR block as follows: $MCi_MISC1 = (MCi_MISC0[BlkPtr] \text{ shifted left 3 bits}) + C000_0400h$. BlkPtr has the same value for all MCi_MISCj .

For more information, see the appropriate BIOS and Kernel Developer's Guide for the processor for its implementation of the AMD64 architecture.

9.4 Initializing the Machine-Check Mechanism

Following a processor reset, all machine-check error-reporting enable bits are disabled. System software must enable these bits before machine-check errors can be reported. Generally, system software should initialize the machine-check mechanism using the following process:

- Execute the CPUID instruction and verify that the processor supports the machine-check exception (MCE) and machine-check registers (MCA). MCE is supported when EDX bit 7 is set to 1, and MCA is supported when EDX bit 14 is set to 1. Software should not proceed with initializing the machine-check mechanism if the machine-check registers are not supported.
- If the machine-check registers are supported, system software should take the following steps:
 - Check to see if the MCG_CTL_P bit in the MCG_CAP register is set to 1. If it is, then the MCG_CTL register is supported by the processor. If the MCG_CTL register is supported, software should set its enable bits to 1 for the machine-check features it uses. Software can load MCG_CTL with all 1s to enable all machine-check features.
 - Read the COUNT field from the MCG_CAP register to determine the number of error-reporting register banks supported by the processor. For each error-reporting register bank, software should set the enable bits to 1 in the MCi_CTL register for the error types it wants the processor to report. Software can load each MCi_CTL with all 1s to enable all error-reporting mechanisms.

The error-reporting register banks are numbered from 0 to one less than the value found in the $MCG_CAP.COUNT$ field. For example, if the COUNT field indicates five register banks are supported, they are numbered 0 to 4.

- For each error-reporting register bank, software should clear all status fields in the MCi_STATUS register by writing all 0s to the register.

It is possible that valid error-status is already reported by the MCi_STATUS registers at the time software clears them. The status can reflect fatal errors recorded before a warm reset, or errors recorded during the system power-up and boot process. Before clearing the MCi_STATUS registers, software should examine their contents and log any errors found.
- As a final step in the initialization process, system software should enable the machine-check exception by setting CR4.MCE (bit 6) to 1.

9.5 Using Machine Check Features

System software can detect and handle machine-check errors using two methods:

- Software can periodically examine the machine-check status registers for reported errors, and log any errors found.
- Software can enable the machine-check exception (#MC). When an uncorrectable error occurs, the processor immediately transfers control to the machine-check exception handler. In this case, system software provides a machine-check exception handler that, at a minimum, logs detected errors. The exception handler can be designed for a specific processor implementation or can be generalized to work on multiple implementations.

9.5.1 Handling Machine Check Exceptions

The processor uses the interrupt control-transfer mechanism to invoke an exception handler after a machine-check exception occurs. This requires system software to initialize the interrupt-descriptor table (IDT) with either an interrupt gate or a trap gate that references the interrupt handler. See “Legacy Protected-Mode Interrupt Control Transfers” on page 231 and “Long-Mode Interrupt Control Transfers” on page 241 for more information on interrupt control transfers.

At a minimum, the machine-check exception handler must be capable of logging errors for later examination. This can be a sufficient implementation for some handlers. More thorough exception-handler implementations can analyze the error to determine if it is unrecoverable, and whether it can be recovered in software.

Machine-check exception handlers that attempt to correct unrecoverable errors must be thorough in their analysis and their corrective actions. The following guidelines should be used when writing such a handler:

- All status registers in the error-reporting register banks must be examined to identify the cause or causes of the machine-check exception. Read the COUNT field from MCG_CAP to determine the number of status registers supported by the processor. The status registers are numbered from 0 to one less than the value found in the MCG_CAP.COUNT field. For example, if the COUNT field indicates five status registers are supported, they are named MC0_STATUS to MC4_STATUS.
- Check the valid bit in each status register (MC_{*i*}_STATUS.VAL). The MC_{*i*}_STATUS register does not need to be examined when its valid bit is clear.
- Check the valid MC_{*i*}_STATUS registers to see if error recovery is possible. Error recovery is not possible when:
 - The processor-context corrupt bit (MC_{*i*}_STATUS.PCC) is set to 1.
 - The error-overflow status bit (MC_{*i*}_STATUS.OVER) is set to 1. This bit indicates that more than one machine-check error occurred, but only one error is reported by the status register.

If error recovery is not possible, the handler should log the error information and return to the operating system.

- Check the MC_{*i*}_STATUS.UC bit to see if the processor corrected the error. If UC=1, the processor did not correct the error, and the exception handler must correct the error before restarting the interrupted program. If the handler cannot correct the error, it should log the error information and return to the operating system.

- When identifying the error condition, portable exception handlers should examine only the `MCi_STATUS` register MCA error-code field. See “Error Codes” on page 262 for information on interpreting this field.
- If the `MCG_STATUS.RIPV` bit is set to 1, the interrupted program can be restarted reliably at the instruction-pointer address pushed onto the exception-handler stack. If `RIPV=0`, the interrupted program cannot be restarted reliably at that location, although it can be restarted at that location for debugging purposes.
- When logging errors, particularly those that are not recoverable, check the `MCG_STATUS.EIPV` bit to see if the instruction-pointer address pushed onto the exception-handler stack is related to the machine-check error. If `EIPV=0`, the address is not guaranteed to be related to the error.
- Before exiting the machine-check handler, be sure to clear `MCG_STATUS.MCIP` to 0. `MCIP` indicates a machine-check exception occurred. If this bit is set when another machine-check exception occurs, the processor enters the shutdown state.
- When an exception handler is able to, at a minimum, successfully log an error condition, the `MCi_STATUS` registers should be cleared to 0 before exiting the machine-check handler. Software is responsible for clearing at least the `MCi_STATUS.VAL` bits.
- Additional machine-check exception-handler portability can be added by having the handler use the `CPUID` instruction to identify the processor and its capabilities. Implementation-specific software can be added to the machine-check exception handler based on the processor information reported by `CPUID`.

9.5.2 Reporting Correctable Machine Check Errors

Machine-check exceptions do not occur if the error is correctable by the processor. If system software wishes to log and report correctable machine-check errors, a system-service routine must be provided to check the contents of the machine-check status registers for correctable errors. The service routine can be invoked by system software on a periodic basis, or it can be manually invoked by the user as needed.

If the processor supports the machine-check registers, a service routine that reports correctable errors should perform the following:

- Examine each status register (`MCi_STATUS`) in the error-reporting register banks. For each `MCi_STATUS` register with a set valid bit (`VAL=1`), the service routine should:
 - Save the contents of the `MCi_STATUS` register.
 - Save the contents of the corresponding `MCi_ADDR` register if `MCi_STATUS.ADDRV=1`.
 - Save the contents of the corresponding `MCi_MISC` register if `MCi_STATUS.MISCV=1`.
 - Check to see if `MCG_STATUS.MCIP=1`, which indicates that the machine-check exception handler is in progress. If this is the case, then the machine-check exception handler has called the service routine to log the errors. In this situation, the error-logging service routine should determine whether or not the interrupted program is restartable, and report the determination back to the exception handler. The program is *not restartable* if either of the following is true:
 - `MCi_STATUS.PCC=1`, which indicates the processor context is corrupted, or

- MCG_STATUS.RIPV=0, which indicates the interrupted program cannot be restarted reliably at the instruction-pointer address pushed onto the exception-handler stack.
- Once the information found in the error-reporting register banks is saved, the M*C*_{*i*}_STATUS register should be cleared to 0. This allows the processor to properly report any subsequent errors in the M*C*_{*i*}_STATUS registers.
- The service routine can save the time-stamp counter with each error logged. This can help in determining how frequently errors occur. For further information, see “Time-Stamp Counter” on page 346.
- In multiprocessor configurations, the service routine can save the processor-node identifier. This can help locate a failing multiprocessor-system component, which can then be isolated from the rest of the system. For further information, see the documentation for particular implementations of the architecture.

10 System-Management Mode

System-management mode (SMM) is an operating mode designed for system-control activities like power management. Normally, these activities are transparent to conventional operating systems and applications. SMM is used by system-specific BIOS (basic input-output system) and specialized low-level device drivers, rather than the operating system.

The SMM interrupt-handling mechanism differs substantially from the standard interrupt-handling mechanism described in Chapter 8, “Exceptions and Interrupts.” SMM is entered using a special external interrupt called the *system-management interrupt* (SMI). After an SMI is received by the processor, the processor saves the processor state in a separate address space, called *SMRAM*. The SMM-handler software and data structures are also located in the SMRAM space. Interrupts and exceptions that ordinarily cause control transfers to the operating system are disabled when SMM is entered. The processor exits SMM, restores the saved processor state, and resumes normal execution by using a special instruction, *RSM*.

In SMM, address translation is disabled and addressing is similar to real mode. SMM programs can address up to 4 Gbytes of physical memory. See “SMM Operating-Environment” on page 281 for additional information on memory addressing in SMM.

The following sections describe the components of the SMM mechanism:

- “*SMM Resources*” on page 272—this section describes SMRAM, the SMRAM save-state area used to hold the processor state, and special SMRAM save-state entries used in support of SMM.
- “*Using SMM*” on page 281—this section describes the mechanism of entering and exiting SMM. It also describes SMM memory allocation, addressing, and interrupts and exceptions.

Of these mechanisms, only the format of the SMRAM save-state area differs between the AMD64 architecture and the legacy architecture.

10.1 SMM Differences

There are functional differences between the SMM support in the AMD64 architecture and the SMM support found in previous architectures. These are:

- The SMRAM state-save area layout is changed to hold the 64-bit processor state.
- The initial processor state upon entering SMM is expanded to reflect the 64-bit nature of the processor.
- New conditions exist that can cause a processor shutdown while in SMM.
- The auto-halt restart and I/O-instruction restart entries in the SMRAM state-save area are one byte each instead of two bytes each.
- SMRAM caching considerations are modified because the legacy FLUSH# external signal (writeback, if modified, and invalidate) is not supported on implementations of the AMD64 architecture.

- Some previous AMD x86 processors saved and restored the CR2 register in the SMRAM state-save area. This register is not saved by the SMM implementation in the AMD64 architecture. SMM handlers that save and restore CR2 must perform the operation in software.

10.2 SMM Resources

The SMM resources supported by the processor consist of SMRAM, the SMRAM state-save area, and special entries within the SMRAM state-save area. In addition to the save-state area, SMRAM includes space for the SMM handler.

10.2.1 SMRAM

SMRAM is the memory-address space accessed by the processor when in SMM. The default size of SMRAM is 64 Kbytes and can range in size between 32 Kbytes and 4 Gbytes. System logic can use physically separate SMRAM and main memory, directing memory transactions to SMRAM after recognizing SMM is entered, and redirecting memory transactions back to system memory after recognizing SMM is exited. When separate SMRAM and main memory are used, the system designer needs to provide a method of mapping SMRAM into main memory so that the SMI handler and data structures can be loaded.

Figure 10-1 on page 273 shows the default SMRAM memory map. The default SMRAM code-segment (CS) has a base address of 0003_0000h (the base address is automatically scaled by the processor using the CS-selector register, which is set to the value 3000h). This default SMRAM-base address is known as *SMBASE*. A 64-Kbyte memory region, addressed from 0003_0000h to 0003_FFFFh, makes up the default SMRAM memory space. The top 32 Kbytes (0003_8000h to 0003_FFFFh) must be supported by system logic, with physical memory covering that entire address range. The top 512 bytes (0003_FE00h to 0003_FFFFh) of this address range are the default *SMM state-save area*. The default entry point for the SMM interrupt handler is located at 0003_8000h.

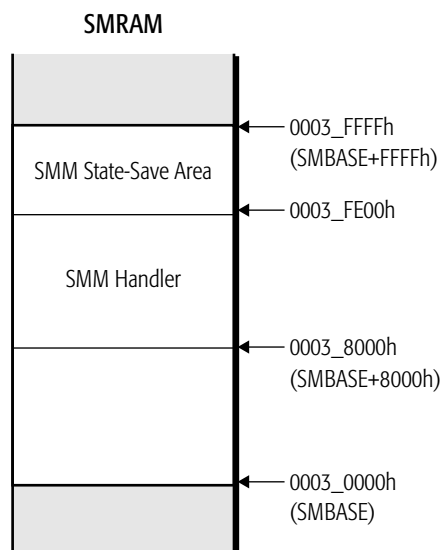

513-250.eps

Figure 10-1. Default SMRAM Memory Map

10.2.2 SMBASE Register

The format of the SMBASE register is shown in Figure 10-2. SMBASE is an internal processor register that holds the value of the SMRAM-base address. SMBASE is set to 30000h after a processor reset.

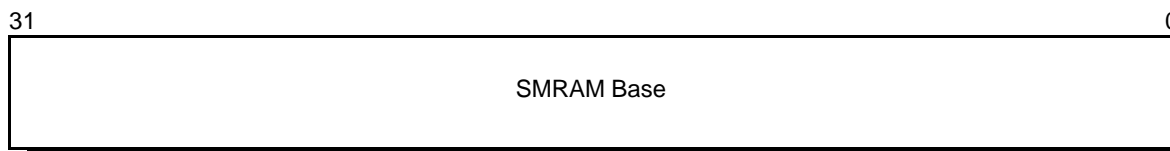

Figure 10-2. SMBASE Register

In some operating environments, relocation of SMRAM to a higher memory area can provide more low memory for legacy software. SMBASE relocation is supported when the SMM-base relocation bit in the SMM-revision identifier (bit 17) is set to 1. In processors implementing the AMD64 architecture, SMBASE relocation is always supported.

Software can only modify SMBASE (relocate the SMRAM-base address) by entering SMM, modifying the SMBASE image stored in the SMRAM state-save area, and exiting SMM. The SMM-

handler entry point must be loaded at the new memory location specified by SMBASE+8000h. The next time SMM is entered, the processor saves its state in the new state-save area at SMBASE+0FE00h, and begins executing the SMM handler at SMBASE+8000h. The new SMBASE address is used for every SMM until it is changed, or a hardware reset occurs.

When SMBASE is used to relocate SMRAM to an address above 1 Mbyte, 32-bit address-size-override prefixes must be used to access this memory. This is because addressing in SMM behaves as it does in real mode, with a 16-bit default operand size and address size. The values in the 16-bit segment-selector registers are left-shifted four bits to form a 20-bit segment-base address. Without using address-size overrides, the maximum computable address is 10FFEFh.

Because SMM memory-addressing is similar to real-mode addressing, the SMBASE address must be less than 4 Gbytes. Physical-address extensions (CR4.PAE) should not be enabled in SMM, restricting the SMRAM address space to the range 0h to 0FFFF_FFFFh.

10.2.3 SMRAM State-Save Area

When an SMI occurs, the processor saves its state in the 512-byte SMRAM state-save area during the control transfer into SMM. The format of the state-save area defined by the AMD64 architecture is shown in Table 10-1. This table shows the offsets in the SMRAM state-save area relative to the SMRAM-base address. The state-save area is located between offset 0_FE00h (SMBASE+0_FE00h) and offset 0_FFFFh (SMBASE+0_FFFFh). Software should not modify offsets specified as read-only or reserved, otherwise unpredictable results can occur.

Table 10-1. AMD64 Architecture SMM State-Save Area

Offset (Hex) from SMBASE	Contents		Size	Allowable Access
FE00h	ES	Selector	Word	Read-Only
FE02h		Attributes	Word	
FE04h		Limit	Doubleword	
FE08h		Base	Quadword	
FE10h	CS	Selector	Word	Read-Only
FE12h		Attributes	Word	
FE14h		Limit	Doubleword	
FE18h		Base	Quadword	
FE20h	SS	Selector	Word	Read-Only
FE22h		Attributes	Word	
FE24h		Limit	Doubleword	
FE28h		Base	Quadword	
Note:				
1. The offset for the SMM-revision identifier is compatible with previous implementations.				

Table 10-1. AMD64 Architecture SMM State-Save Area (continued)

Offset (Hex) from SMBASE	Contents		Size	Allowable Access
FE30h	DS	Selector	Word	Read-Only
FE32h		Attributes	Word	
FE34h		Limit	Doubleword	
FE38h		Base	Quadword	
FE40h	FS	Selector	Word	Read-Only
FE42h		Attributes	Word	
FE44h		Limit	Doubleword	
FE48h		Base	Quadword	
FE50h	GS	Selector	Word	Read-Only
FE52h		Attributes	Word	
FE54h		Limit	Doubleword	
FE58h		Base	Quadword	
FE60h–FE63h	GDTR	Reserved	4 Bytes	Read-Only
FE64h		Limit	Word	
FE66h–FE67h		Reserved	2 Bytes	
FE68h		Base	Quadword	
FE70h	LDTR	Selector	Word	Read-Only
FE72h		Attributes	Word	
FE74h		Limit	Doubleword	
FE78h		Base	Quadword	
FE80h–FEB3h	IDTR	Reserved	4 Bytes	Read-Only
FE84h		Limit	Word	
FEB6h–FEB7h		Reserved	2 Bytes	
FE88h		Base	Quadword	
FE90h	TR	Selector	Word	Read-Only
FE92h		Attributes	Word	
FE94h		Limit	Doubleword	
FE98h		Base	Quadword	
FEA0h	I/O Instruction Restart RIP		Quadword	Read-Only
FEA8h	I/O Instruction Restart RCX		Quadword	Read-Only
FEB0h	I/O Instruction Restart RSI		Quadword	Read-Only
FEB8h	I/O Instruction Restart RDI		Quadword	Read-Only
FEC0h	I/O Instruction Restart Dword		Doubleword	Read-Only
FEC4h–FEC7h	Reserved		4 Bytes	—
Note:				
1. The offset for the SMM-revision identifier is compatible with previous implementations.				

Table 10-1. AMD64 Architecture SMM State-Save Area (continued)

Offset (Hex) from SMBASE	Contents	Size	Allowable Access
FEC8h	I/O Instruction Restart	Byte	Read/Write
FEC9h	Auto-Halt Restart	Byte	
FECAh—FECFh	Reserved	5 Bytes	—
FED0h	EFER	Quadword	Read-Only
FED8h	SVM Guest	Quadword	Read-Only
FEE0h	SVM Guest VMCB Physical Address	Quadword	
FEE8h	SVM Guest Virtual Interrupt	Quadword	
FEF0h—FEFBh	Reserved	10 Bytes	—
FEFCh	SMM-Revision Identifier ¹	Doubleword	Read-Only
FF00h	SMBASE	Doubleword	Read/Write
FF04h—FF1Fh	Reserved	27 Bytes	—
FF20h	SVM Guest PAT	Quadword	Read-Only
FF28h	SVM Host EFER	Quadword	
FF30h	SVM Host CR4	Quadword	
FF38h	SVM Host CR3	Quadword	
FF40h	SVM Host CR0	Quadword	
FF48h	CR4	Quadword	Read-Only
FF50h	CR3	Quadword	
FF58h	CR0	Quadword	
FF60h	DR7	Quadword	Read-Only
FF68h	DR6	Quadword	
FF70h	RFLAGS	Quadword	Read/Write
FF78h	RIP	Quadword	Read/Write
FF80h	R15	Quadword	
FF88h	R14	Quadword	
FF90h	R13	Quadword	
FF98h	R12	Quadword	
FFA0h	R11	Quadword	
FFA8h	R10	Quadword	
FFB0h	R9	Quadword	
FFB8h	R8	Quadword	
Note:			
1. The offset for the SMM-revision identifier is compatible with previous implementations.			

Table 10-1. AMD64 Architecture SMM State-Save Area (continued)

Offset (Hex) from SMBASE	Contents	Size	Allowable Access
FFC0h	RDI	Quadword	Read/Write
FFC8h	RSI	Quadword	
FFD0h	RBP	Quadword	
FFD8h	RSP	Quadword	
FFE0h	RBX	Quadword	
FFE8h	RDX	Quadword	
FFF0h	RCX	Quadword	
FFF8h	RAX	Quadword	
Note: 1. The offset for the SMM-revision identifier is compatible with previous implementations.			

A number of other registers are not saved or restored automatically by the SMM mechanism. See “Saving Additional Processor State” on page 283 for information on using these registers in SMM.

As a reference for legacy processor implementations, the legacy SMM state-save area format is shown in Table 10-2. *Implementations of the AMD64 architecture do not use this format.*

Table 10-2. Legacy SMM State-Save Area (Not used by AMD64 Architecture)

Offset (Hex) from SMBASE	Contents	Size	Allowable Access
FE00h—FEF7h	Reserved	248 Bytes	—
FEF8h	SMBASE	Doubleword	Read/Write
FEFCh	SMM-Revision Identifier	Doubleword	Read-Only
FF00h	I/O Instruction Restart	Word	Read/Write
FF02h	Auto-Halt Restart	Word	
FF04h—FF87h	Reserved	132 Bytes	—
FF88h	GDT Base	Doubleword	Read-Only
FF8Ch—FF93h	Reserved	Quadword	—
FF94h	IDT Base	Doubleword	Read-Only
FF98h—FFA7h	Reserved	16 Bytes	—
Note: 1. The offset for the SMM-revision identifier is compatible with previous implementations.			

Table 10-2. Legacy SMM State-Save Area (Not used by AMD64 Architecture) (continued)

Offset (Hex) from SMBASE	Contents	Size	Allowable Access
FFA8h	ES	Doubleword	Read-Only
FFACh	CS	Doubleword	
FFB0h	SS	Doubleword	
FFB4h	DS	Doubleword	
FFB8h	FS	Doubleword	
FFBCh	GS	Doubleword	
FFC0h	LDT Base	Doubleword	Read-Only
FFC4h	TR	Doubleword	
FFC8h	DR7	Doubleword	Read-Only
FFCCh	DR6	Doubleword	
FFD0h	EAX	Doubleword	Read/Write
FFD4h	ECX	Doubleword	
FFD8h	EDX	Doubleword	
FFDCh	EBX	Doubleword	
FFE0h	ESP	Doubleword	
FFE4h	EBP	Doubleword	
FFE8h	ESI	Doubleword	
FFECCh	EDI	Doubleword	
FFF0h	EIP	Doubleword	Read/Write
FFF4h	EFLAGS	Doubleword	Read/Write
FFF8h	CR3	Doubleword	Read-Only
FFFCh	CR0	Doubleword	
Note:			
1. The offset for the SMM-revision identifier is compatible with previous implementations.			

10.2.4 SMM-Revision Identifier

The SMM-revision identifier specifies the SMM version and the available SMM extensions implemented by the processor. Software reads the SMM-revision identifier from offset FEFCh in the SMM state-save area of SMRAM. This offset location is compatible with earlier versions of SMM. Software must not write to this location. Doing so can produce undefined results. Figure 10-3 on page 279 shows the format of the SMM-revision identifier.

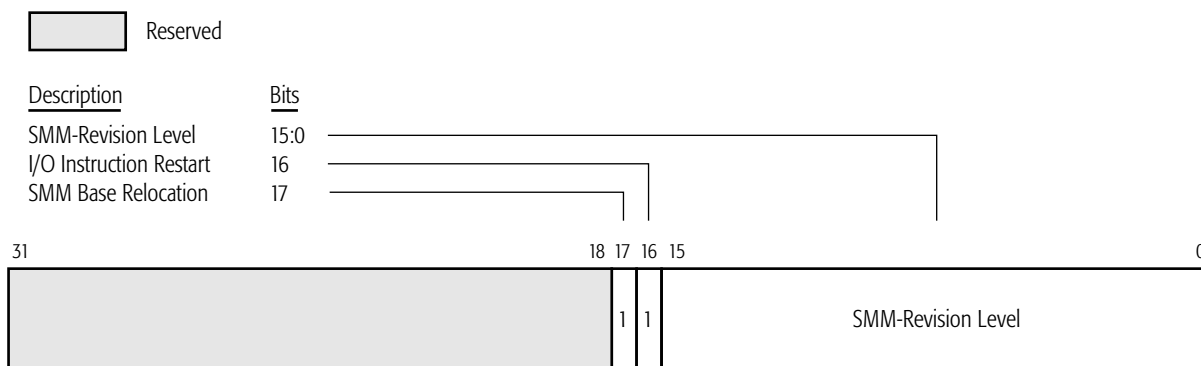

513-251 eps

Figure 10-3. SMM-Revision Identifier

The fields within the SMM-revision identifier are:

- *SMM-revision Level*—Bits 15–0. Specifies the version of SMM supported by the processor. The SMM-revision level is of the form 0_xx64h, where *xx* starts with 00 and is incremented for later revisions to the SMM mechanism.
- *I/O Instruction Restart*—Bit 16. When set to 1, the processor supports restarting I/O instructions that are interrupted by an SMI. This bit is always set to 1 by implementations of the AMD64 architecture. See “I/O Instruction Restart” on page 285 for information on using this feature.
- *SMM Base Relocation*—Bit 17. When set to 1, the processor supports relocation of SMRAM. This bit is always set to 1 by implementations of the AMD64 architecture. See “SMBASE Register” on page 273 for information on using this feature.

All remaining bits in the SMM-revision identifier are reserved.

10.2.5 SMRAM Protected Area

Two areas are provided as safe areas for SMM code and data that are not readily accessible by non-SMM applications. The SMI handler can be located in one of these two ranges, or it can be located outside of these ranges.

The ASeg range is located at a fixed address from A_0000h to B_FFFFh. The TSeg range is located at a variable base specified by the SMM_ADDR MSR with a variable size specified by the SMM_MASK MSR. These ranges must never overlap.

Each CPU memory access is in the TSeg range if the following is true:

$$\text{Phys Addr}[51:17] \& \text{SSM_MASK}[51:17] = \text{SMM_ADDR}[51:17] \& \text{SSM_MASK}[51:17].$$

For example, if the TSeg range spans 256K bytes starting at address 10_0000h, then SSM_ADDR =0010_0000h and SSM_MASK=FFFC_0000h (with zeros in bits 16:0). This results in a TSeg address range from 0010_0000 to 0013_FFFFh.

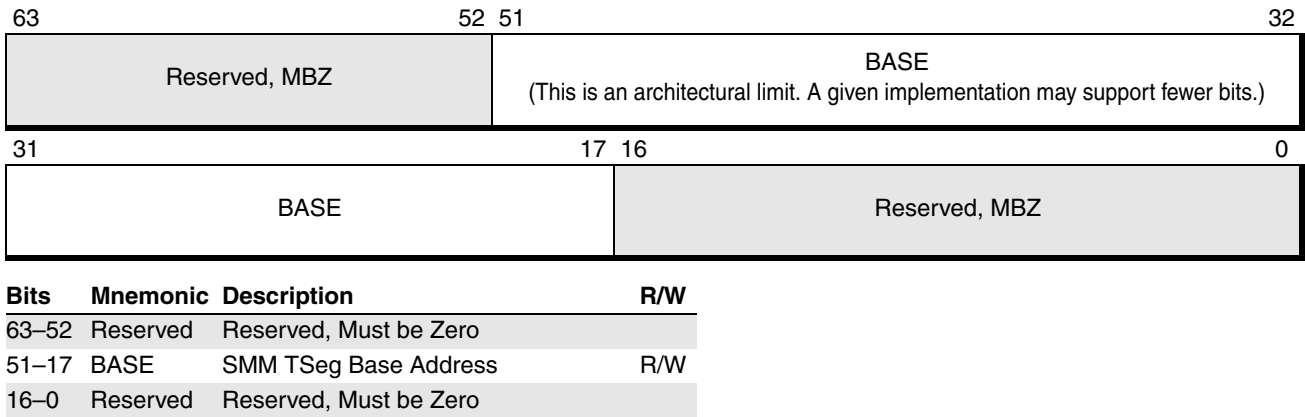

Figure 10-4. SSM_ADDR Register Format

- *SMM TSeg Base Address (BASE)*—Bits 51-17. Specifies the base address of the TSeg range of protected addresses.

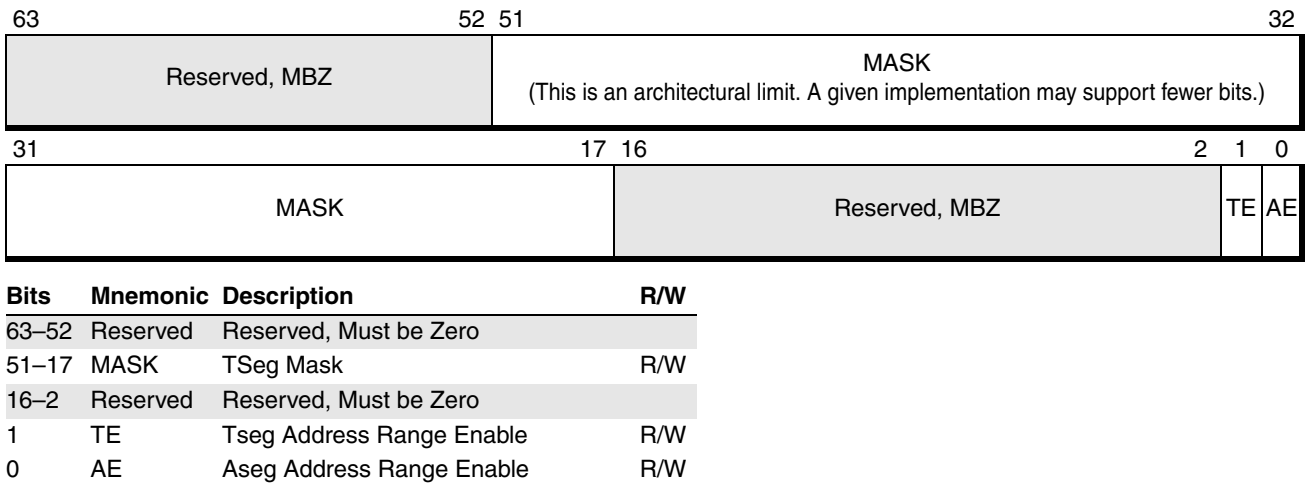

Figure 10-5. SSM_MASK Register Format

- *Aseg Address Range Enable (AE)*—Bit 0. Specifies whether the ASeg address range is enabled for protection. When the bit is set to 1, the ASeg address range is enabled for protection. When cleared to 0, the ASeg address range is disabled for protection.

- *TSeg Address Range Enable (TE)*—Bit 1. Specifies whether the TSeg address range is enabled for protection. When the bit is set to 1, the TSeg address range is enabled for protection. When cleared to 0, the TSeg address range is disabled for protection.
- *TSeg Mask (MASK)*—Bits 51-17. Specifies the mask used to determine the TSeg range of protected addresses. The Phys address[51:17] is in the TSeg range if the following is true:

$$\text{Phys Addr}[51:17] \& \text{SSM_MASK}[51:17] = \text{SMM_ADDR}[51:17] \& \text{SSM_MASK}[51:17].$$

10.3 Using SMM

10.3.1 System-Management Interrupt (SMI)

SMM is entered using the system-management interrupt (SMI). SMI is an external non-maskable interrupt that operates differently from and independently of other interrupts. SMI has priority over all other external interrupts, including NMI (see “Priorities” on page 226 for a list of the interrupt priorities). SMIs are disabled when in SMM, which prevents reentrant calls to the SMM handler.

When an SMI is received by the processor, the processor stops fetching instructions and waits for currently-executing instructions to complete and write their results. The SMI also waits for all buffered memory writes to update the caches or system memory. When these activities are complete, the processor uses implementation-dependent external signalling to acknowledge back to the system that it has received the SMI.

10.3.2 SMM Operating-Environment

The SMM operating-environment is similar to real mode, except that the segment limits in SMM are 4 Gbytes rather than 64 Kbytes. This allows an SMM handler to address memory in the range from 0h to 0FFFF_FFFFh. As with real mode, segment-base addresses are restricted to 20 bits in SMM, and the default operand-size and address-size is 16 bits. To address memory locations above 1 Mbyte, the SMM handler must use the 32-bit operand-size-override and address-size-override prefixes.

After saving the processor state in the SMRAM state-save area, a processor running in SMM sets the segment-selector registers and control registers into a state consistent with real mode. Other registers are also initialized upon entering SMM, as shown in Table 10-3.

Table 10-3. SMM Register Initialization

Register	Initial SMM Contents	
CS	Selector	SMBASE right-shifted 4 bits
	Base	SMBASE
	Limit	FFFF_FFFFh
	Attr	Read-Write-Execute

Table 10-3. SMM Register Initialization (continued)

Register		Initial SMM Contents
DS, ES, FS, GS, SS	Selector	0000h
	Base	0000_0000_0000_0000h
	Limit	FFFF_FFFFh
	Attr	Read-Write
RIP		0000_0000_0000_8000h
RFLAGS		0000_0000_0000_0002h
CR0		PE, EM, TS, PG bits cleared to 0. All other bits are unmodified.
CR4		0000_0000_0000_0000h
DR7		0000_0000_0000_0400h
EFER		0000_0000_0000_0000h

10.3.3 Exceptions and Interrupts

All hardware interrupts are disabled upon entering SMM, but exceptions and software interrupts are not disabled. If necessary, the SMM handler can re-enable hardware interrupts. Software that handles interrupts in SMM should consider the following:

- *SMI*—If an SMI occurs while the processor is in SMM, it is latched by the processor. The latched SMI occurs when the processor leaves SMM.
- *NMI*—If an NMI occurs while the processor is in SMM, it is latched by the processor, but the NMI handler is not invoked until the processor leaves SMM with the execution of an RSM instruction. A pending NMI causes the handler to be invoked immediately after the RSM completes and before the first instruction in the interrupted program is executed.

An SMM handler can unmask NMI interrupts by simply executing an IRET. Upon completion of the IRET instruction, the processor recognizes the pending NMI, and transfers control to the NMI handler. Once an NMI is recognized within SMM using this technique, subsequent NMIs are recognized until SMM is exited. Later SMIs cause NMIs to be masked, until the SMM handler unmask them.

- *Exceptions*—Exceptions (internal processor interrupts) are not disabled and can occur while in SMM. Therefore, the SMM-handler software should be written to avoid generating exceptions.
- *Software Interrupts*—The software-interrupt instructions (BOUND, INT n , INT3, and INTO) can be executed while in SMM. However, it is not recommended that the SMM handler use these instructions.
- *Maskable Interrupts*—RFLAGS.IF is cleared to 0 by the processor when SMM is entered. Software can re-enable maskable interrupts while in SMM, but it must follow the guidelines listed below for handling interrupts.
- *Debug Interrupts*—The processor disables the debug interrupts when SMM is entered by clearing DR7 to 0 and clearing RFLAGS.TF to 0. The SMM handler can re-enable the debug facilities while in SMM, but it must follow the guidelines listed below for handling interrupts.

- *INIT*—The processor does not recognize *INIT* while in SMM.

Because the *RFLAGS.IF* bit is cleared when entering SMM, the *HLT* instruction should not be executed in SMM without first setting the *RFLAGS.IF* bit to 1. Setting this bit to 1 allows the processor to exit the halt state by using an external maskable interrupt.

In the cases where an SMM handler must accept and handle interrupts and exceptions, several guidelines must be followed:

- Interrupt handlers must be loaded and accessible before enabling interrupts.
- A real-mode interrupt-vector table located at virtual (linear) address 0 is required.
- Segments accessed by the interrupt handler cannot have a base address greater than 20 bits because of the real-mode addressing used in SMM. In SMM, the 16-bit value stored in the segment-selector register is left-shifted four bits to form the 20-bit segment-base address, like real mode.
- Only the *IP* (*rIP*[15:0]) is pushed onto the stack as a result of an interrupt in SMM, because of the real-mode addressing used in SMM. If the SMM handler is interrupted at a code-segment offset above 64 Kbytes, then the return address on the stack must be adjusted by the interrupt-handler, and a *RET* instruction with a 32-bit operand-size override must be used to return to the SMM handler.
- If the interrupt-handler is located below 1 Mbyte, and the SMM handler is located above 1 Mbyte, a *RET* instruction cannot be used to return to the SMM handler. In this case, the interrupt handler can adjust the return pointer on the stack, and use a far *CALL* to transfer control back to the SMM handler.

10.3.4 Invalidating the Caches

The processor can cache SMRAM-memory locations. If the system implements physically separate SMRAM and system memory, it is possible for SMRAM and system memory locations to alias into identical cache locations. In some processor implementations, the cache contents must be written to memory and invalidated when SMM is entered *and* exited. This prevents the processor from using previously-cached main-memory locations as aliases for SMRAM-memory locations when SMM is entered, and vice-versa when SMM is exited.

Implementations of the AMD64 architecture *do not require cache invalidation* when entering and exiting SMM. Internally, the processor keeps track of SMRAM and system-memory accesses separately and properly handles situations where aliasing occurs. Cached system memory and SMRAM locations can persist across SMM mode changes. Removal of the requirement to writeback and invalidate the cache simplifies SMM entry and exit and allows SMM code to execute more rapidly.

10.3.5 Saving Additional Processor State

Several registers are not saved or restored automatically by the SMM mechanism. These are:

- The 128-bit media instruction registers.
- The 64-bit media instruction registers.
- The x87 floating-point registers.

- The page-fault linear-address register (CR2).
- The task-priority register (CR8).
- The debug registers, DR0, DR1, DR2, and DR3.
- The memory-type range registers (MTRRs).
- Model-specific registers (MSRs).

These registers are not saved because SMM handlers do not normally use or modify them. If an SMI results in a processor reset (due to powering down the processor, for example) or the SMM handler modifies the contents of the unsaved registers, the SMM handler should save and restore the original contents of those registers. The unsaved registers, along with those stored in the SMRAM state-save area, need to be saved in a non-volatile storage location if a processor reset occurs. The SMM handler should execute the CPUID instruction to determine the feature set available in the processor, and be able to save and restore the registers required by those features.

The SMM handler can execute any of the 128-bit media, 64-bit media, or x87 instructions. A simple method for saving and restoring those registers is to use the FXSAVE and FXRSTOR instructions, respectively, if it is supported by the processor. See “Saving Media and x87 Processor State” on page 295 for information on saving and restoring those registers.

Floating-point exceptions can occur when the SMM handler uses media or x87 floating-point instructions. If the SMM handler uses floating-point exception handlers, they must follow the usage guidelines established in “Exceptions and Interrupts” on page 282. A simple method for dealing with floating-point exceptions while in SMM is to simply mask all exception conditions using the appropriate floating-point control register. When the exceptions are masked, the processor handles floating-point exceptions internally in a default manner, and allows execution to continue uninterrupted.

10.3.6 Operating in Protected Mode and Long Mode

Software can enable protected mode from SMM and it can also enable and activate long mode. An SMM handler can use this capability to enter 64-bit mode and save additional processor state that cannot be accessed from outside 64-bit mode (for example, the most-significant 32 bits of CR2).

10.3.7 Auto-Halt Restart

The auto-halt restart entry is located at offset FEC9h in the SMM state-save area. The size of this field is one byte, as compared with two bytes in previous versions of SMM.

When entering SMM, the processor loads the auto-halt restart entry to indicate whether SMM was entered from the halt state, as follows:

- Bit 0 indicates the processor state upon entering SMM:
 - When set to 1, the processor entered SMM from the halt state.
 - When cleared to 0, the processor did not enter SMM from the halt state.
- Bits 7–1 are cleared to 0.

The SMM handler can write the auto-halt restart entry to specify whether the return from SMM should take the processor back to the halt state or to the instruction-execution state specified by the SMM state-save area. The values written are:

- *Clear to 00h*—The processor returns to the state specified by the SMM state-save area.
- *Set to any non-zero value*—The processor returns to the halt state.

If the return from SMM takes the processor back to the halt state, the HLT instruction is not re-executed. However, the halt special bus-cycle is driven on the processor bus after the RSM instruction executes.

The result of entering SMM from a non-halt state and returning to a halt state is not predictable.

10.3.8 I/O Instruction Restart

The I/O-instruction restart entry is located at offset FEC8h in the SMM state-save area. The size of this field is one byte, as compared with two bytes in previous versions of SMM. The I/O-instruction restart mechanism is supported when the I/O-instruction restart bit (bit 16) in the SMM-revision identifier is set to 1. This bit is always set to 1 in the AMD64 architecture.

When an I/O instruction is interrupted by an SMI, the I/O-instruction restart entry specifies whether the interrupted I/O instruction should be re-executed following an RSM that returns from SMM. Re-executing a trapped I/O instruction is useful, for example, when an I/O write is performed to a powered-down disk drive. When this occurs, the system logic monitoring the access can issue an SMI to have the SMM handler power-up the disk drive and retry the I/O write. The SMM handler does this by querying system logic and detecting the failed I/O write, asking system logic to initiate the disk-drive power-up sequence, enabling the I/O instruction restart mechanism, and returning from SMM. Upon returning from SMM, the I/O write to the disk drive is restarted.

When an SMI occurs, the processor always clears the I/O-instruction restart entry to 0. If the SMI interrupted an I/O instruction, then the SMM handler can modify the I/O-instruction restart entry as follows:

- *Clear to 00h (default value)*—The I/O instruction is not restarted, and the instruction following the interrupted I/O-instruction is executed. When a REP (repeat) prefix is used with an I/O instruction, it is possible that the next instruction to be executed is the next I/O instruction in the repeat loop.
- *Set to any non-zero value*—The I/O instruction is restarted.

While in SMM, the handler must determine the cause of the SMI and examine the processor state at the time the SMI occurred to determine whether or not an I/O instruction was interrupted. Implementations provide state information in the SMM save-state area to assist in this determination:

- I/O Instruction Restart DWORD—indicates whether the SMI interrupted an I/O instruction, and saves extra information describing the I/O instruction.
- I/O Instruction Restart RIP—the RIP of the interrupted I/O instruction.
- I/O Instruction Restart RCX—the RCX of the interrupted I/O instruction.
- I/O Instruction Restart RSI—the RSI of the interrupted I/O instruction.

- Invalid returns to long mode, including:
 - EFER.LME=1, CR0.PG=1, and CR4.PAE=0.
 - EFER.LME=1, CR0.PG=1, CR4.PAE=1, CS.L=1, and CS.D=1.
- The SSM revision identifier is modified.

Some SMRAM state-save-area conditions are ignored, and the registers, or bits within the registers, are restored in a default manner by the processor. This avoids a processor shutdown when an invalid condition is stored in SMRAM. The default conditions restored by the processor are:

- The EFER.LMA register bit is set to the value obtained by logically ANDing the SMRAM values of EFER.LME, CR0.PG, and CR4.PAE.
- The rFLAGS.VM register bit is set to the value obtained by logically ANDing the SMRAM values of rFLAGS.VM, CR0.PE, and the inverse of EFER.LMA.
- The base values of FS, GS, GDTR, IDTR, LDTR, and TR are restored in canonical form. Those values are sign-extended to bit 63 using the most-significant implemented bit.
- Unimplemented segment-base bits in the CS, DS, ES, and SS registers are cleared to 0.

11 128-Bit, 64-Bit, and x87 Programming

This chapter describes the system-software implications of supporting applications that use the 128-bit media, 64-bit media, and x87 instructions. Throughout this chapter, these instructions are collectively referred to as *media and x87* (media/x87) instructions. A complete listing of the instructions that fall in this category—and the detailed operation of each instruction—can be found in volumes 4 and 5. Refer to Volume 1 for information on using these instructions in application software.

11.1 Overview of System-Software Considerations

Processor implementations can support different combinations of the 128-bit media, 64-bit media, and x87 instruction sets. Two sets of registers—independent of the general-purpose registers—support these instructions. The 128-bit media instructions operate on the XMM registers, and the 64-bit media and x87-instructions operate on the aliased MMX™/x87 registers. The 128-bit media and x87 floating-point instruction sets have special status registers, control registers, exception vectors, and system-software control bits for managing the operating environment. System software that supports use of these instructions must be able to manage these resources properly including:

- Detecting support for the instruction set, and enabling any optional features, as necessary.
- Saving and restoring the processor media or x87 state.
- Execution of floating-point instructions (media or x87) can produce exceptions. System software must supply exception handlers for all unmasked floating-point exceptions.

11.2 Determining Media and x87 Feature Support

The support of 128-bit media, 64-bit media, and x87 instructions is implementation dependent. System software executes the CPUID instruction to determine whether a processor implements any of these features (see “Processor Feature Identification” on page 61 for more information on using the CPUID instruction). After CPUID is executed with function 1 and function 8000_0001h, feature support can be determined by examining the contents of the ECX and EDX registers. General guidelines for determining feature support are given in the list below. A few instructions belong to more than one instruction subset. Refer to “Instruction Subsets and CPUID Feature Sets” in Volume 3 for specific information.

- 128-bit media instructions are supported when:
 - EDX[25] = 1 for SSE instructions. (Returned by CPUID function 1.)
 - EDX[26] = 1 for SSE2 instructions. (Returned by CPUID function 1.)
 - ECX[0] = 1 for SSE3 instructions. (Returned by CPUID function 1.)
 - ECX[6] = 1 for SSE4A support (Returned by CPUID function 8000_0001h)
- 64-bit media instructions are supported when:
 - EDX[23]=1 for MMX instructions. (Returned by CPUID 1 and function 8000_0001h.)

- EDX[22]=1 for AMD extensions to MMX instructions. (Returned by CUID function 8000_0001h.)
- EDX[31]=1 for AMD 3DNow!™ instructions. (Returned by CUID function 8000_0001h.)
- EDX[30]=1 for AMD extensions to 3DNow! instructions. (Returned by CUID function 8000_0001h.)
- x87 floating-point instructions are supported when:
 - EDX[0]=1. (Returned by CUID function 1 and function 8000_0001h.)
- FXSAVE and FXRSTOR instructions are supported when:
 - EDX[24]=1. These instructions save and restore the entire media and x87 processor state. (Returned by CUID function 1 and function 8000_0001h.)

If software attempts to execute an instruction belonging to an unsupported instruction subset, an invalid-opcode exception (#UD) occurs. For a summary of instruction subsets, see “Instruction Subsets and CUID Feature Sets” in Volume 3.

11.3 Enabling 128-Bit Media Instructions

Use of the 128-bit media instructions requires system software to support SSE, SSE2, SSE3 and/or SSE4a features, but also the FXSAVE and FXRSTOR instructions, which are used to save and restore the 128-bit media state (see “FXSAVE and FXRSTOR Instructions” on page 300). When these instructions are supported, system software must set CR4.OSFXSR=1 to let the processor know that the software uses these instructions. When the processor detects CR4.OSFXSR=1, it allows execution of the 128-bit media instructions. If system software does not set CR4.OSFXSR to 1, attempts to execute 128-bit media instructions cause an invalid-opcode exception (#UD).

System software must also *clear* the CR0.EM (emulate coprocessor) bit to 0, otherwise an attempt to execute a 128-bit media instruction causes a #UD exception.

System software should also *set* the CR0.MP (monitor coprocessor) bit to 1. When CR0.EM=0 and CR0.MP=1, all media instructions, x87 instructions, and the FWAIT/WAIT instructions cause a device-not-available exception (#NM) when the CR0.TS bit is set. System software can use the #NM exception to perform lazy context switching, saving and restoring media and x87 state only when necessary after a task switch. See “CR0 Register” on page 42 for more information.

System software must supply an exception handler if unmasked 128-bit media floating-point exceptions are allowed to occur. When an unmasked exception is detected, the processor transfers control to the SIMD floating-point exception (#XF) handler provided by the operating system. System software must let the processor know that the #XF handler is available by setting CR4.OSXMMEXCPT to 1. If this bit is set to 1, the processor transfers control to the #XF handler when it detects an unmasked exception, otherwise a #UD exception occurs. When the processor detects a masked exception, it handles it in a default manner regardless of the CR4.OSXMMEXCPT value.

11.4 Media and x87 Processor State

The media and x87 processor state includes the contents of the registers used by 128-bit media, 64-bit media, and x87 instructions. System software that supports such applications must be capable of saving and restoring these registers.

11.4.1 128-Bit Media State

Figure 11-1 on page 292 shows the registers whose contents are affected by execution of 128-bit media instructions. These include:

- *xmm0–xmm15*—Sixteen 128-bit media registers. In legacy and compatibility modes, software access is limited to the first eight registers, XMM0–XMM7.
- *MXCSR*—The 32-bit control and status register.

All of the above registers are visible to 128-bit media application software. Refer to “128-Bit Media and Scientific Programming” in Volume 1 for more information on these registers.

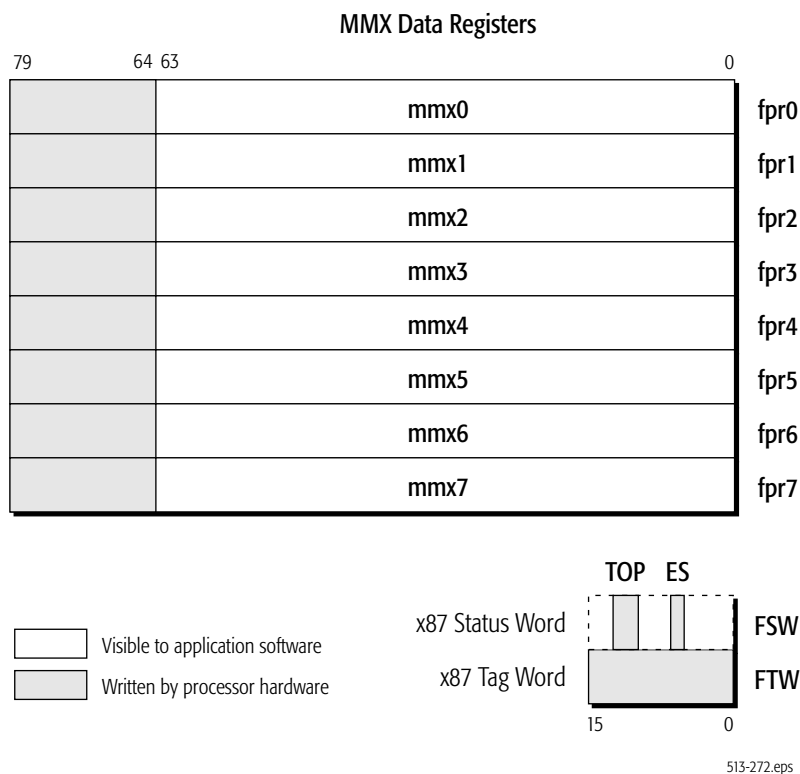

Figure 11-2. 64-Bit Media-Instruction State

The 64-bit media instructions and x87 floating-point instructions share the same physical data registers. Figure 11-2 shows how the 64-bit registers (MMX0–MMX7) are aliased onto the low 64 bits of the 80-bit x87 floating-point physical data registers (FPR0–FPR7). Refer to “64-Bit Media Programming” in Volume 1 for more information on these registers.

Of the registers shown in Figure 11-2, only the eight 64-bit MMX registers are visible to 64-bit media application software. The processor maintains the contents of the two fields of the x87 status word—top-of-stack-pointer (TOP) and exception summary (ES)—and the 16-bit x87 tag word during execution of 64-bit media instructions, as described in “Actions Taken on Executing 64-Bit Media Instructions” in Volume 1.

64-bit media instructions do not generate x87 floating-point exceptions, nor do they set any status flags. However, 64-bit media instructions can trigger an unmasked floating-point exception caused by a previously executed x87 instruction. 64-bit media instructions do this by reading the x87 FSW.ES bit to determine whether such an exception is pending.

11.4.3 x87 State

Figure 11-3 on page 295 shows the registers whose contents are affected by execution of x87 floating-point instructions. These registers include:

- *fpr0–fpr7*—Eight 80-bit floating-point physical registers.
- *FCW*—The 16-bit x87 control word register.
- *FSW*—The 16-bit x87 status word register.
- *FTW*—The 16-bit x87 tag word.
- *Last x87 Instruction Pointer*—This value is a pointer (32-bit, 48-bit, or 64-bit, depending on effective operand size and mode) to the last non-control x87 floating-point instruction executed.
- *Last x87 Data Pointer*—The pointer (32-bit, 48-bit, or 64-bit, depending on effective operand size and mode) to the data operand referenced by the last non-control x87 floating-point instruction executed, if that instruction referenced memory; if it did not, then this value is implementation dependent.
- *Last x87 Opcode*—An 11-bit permutation of the instruction opcode from the last non-control x87 floating-point instruction executed.

Of the registers shown in Figure 11-3 on page 295, only FPR0–FPR7, FCW, and FSW are directly updated by x87 application software. The processor maintains the contents of the FTW, instruction and data pointers, and opcode registers during execution of x87 instructions. Refer to “Registers” in Volume 1 for more information on these registers.

The 11-bit instruction opcode register holds a permutation of the two-byte instruction opcode from the last non-control x87 instruction executed by the processor. (For a definition of *non-control x87 instruction*, see “Control” in Volume 1.) The opcode field is formed as follows:

- Opcode Register Field[10:8] = First x87 opcode byte[2:0].
- Opcode Register Field[7:0] = Second x87 opcode byte[7:0].

For example, the x87 opcode D9 F8h is stored in the opcode register as 001_1111_1000b. The low-order three bits of the first opcode byte, D9h (1101_1001b), are stored in opcode-register bits 10–8. The second opcode byte, F8h (1111_1000b), is stored in bits 7–0 of the opcode register. The high-order five bits of the first opcode byte (1101_1b) are not needed because they are identical for all x87 instructions.

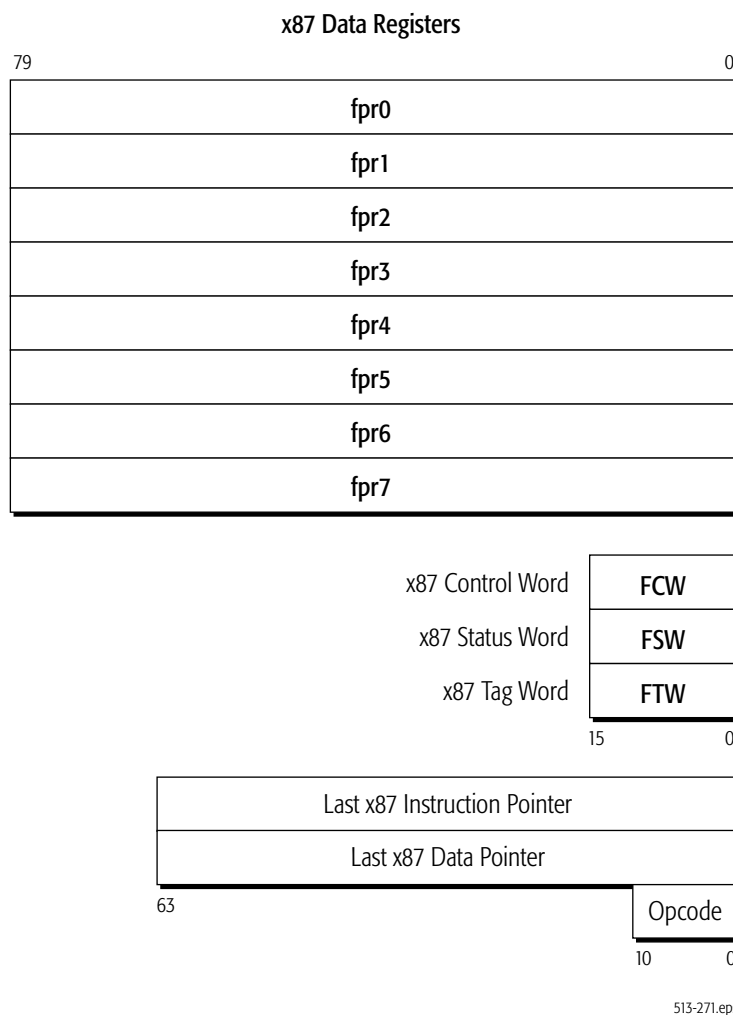

Figure 11-3. x87-Instruction State

11.4.4 Saving Media and x87 Processor State

In most cases, operating systems, exception handlers, and device drivers should save and restore the media and/or x87 processor state between task switches or other interventions in the execution of 128-bit, 64-bit, or x87 procedures. Application programs are also free to save and restore state at any time.

In general, system software should use the FXSAVE and FXRSTOR instructions to save and restore the entire media and x87 processor state. The FSAVE/FNSAVE and FRSTOR instructions can be used for saving and restoring the x87 state. Because the 64-bit media registers are physically aliased onto the x87 registers, the FSAVE/FNSAVE and FRSTOR instructions can also be used to save and restore the 64-bit media state. However, FSAVE/FNSAVE and FRSTOR do not save or restore the 128-bit media state.

FSAVE/FNSAVE and FRSTOR Instructions. The FSAVE/FNSAVE and FRSTOR instructions save and restore the entire register state for 64-bit media instructions and x87 floating-point instructions. The FSAVE instruction stores the register state, but only after handling any pending unmasked-x87 floating-point exceptions. The FNSAVE instruction stores the register state but skips the reporting and handling of these exceptions. The state of all MMX/FPR registers is saved, as well as all other x87 state (the control word register, status word register, tag word, instruction pointer, data pointer, and last opcode). After saving this state, the tag state for all MMX/FPR registers is changed to *empty* and is thus available for a new procedure.

Starting on page 297, Figure 11-4 through Figure 11-7 show the memory formats used by the FSAVE/FNSAVE and FRSTOR instructions when storing the x87 state in various processor modes and using various effective-operand sizes. This state includes:

- *x87 Data Registers*
 - FPR0–FPR7 80-bit physical data registers.
- *x87 Environment*
 - FCW: x87 control word register
 - FSW: x87 status word register
 - FTW: x87 tag word
 - Last x87 instruction pointer
 - Last x87 data pointer
 - Last x87 opcode

The eight data registers are stored in the 80 bytes following the environment information. Instead of storing these registers in their physical order (FPR0–FPR7), the processor stores the registers in the their stack order, ST(0)–ST(7), beginning with the top-of-stack, ST(0).

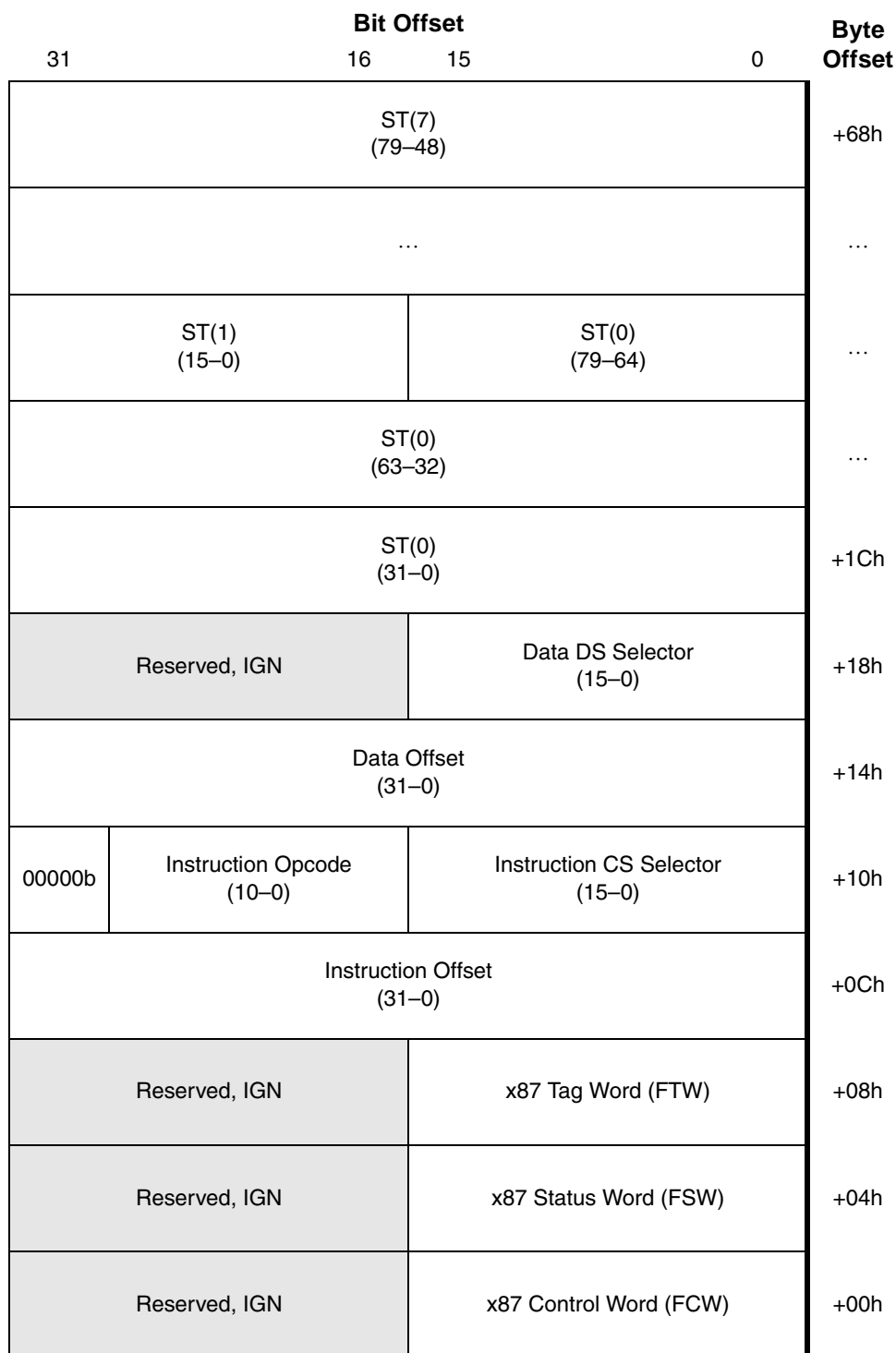

Figure 11-4. FSAVE/FNSAVE Image (32-Bit, Protected Mode)

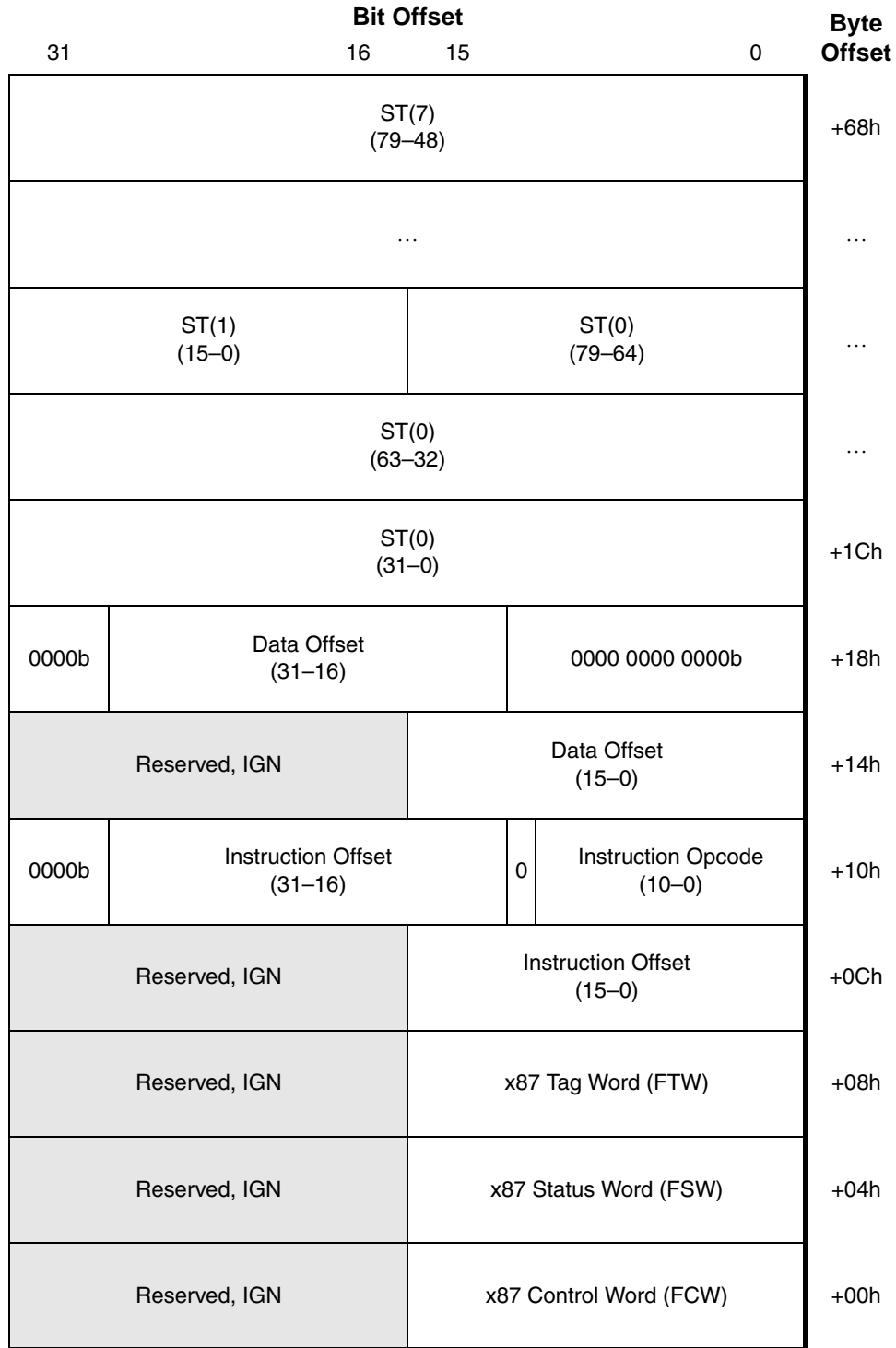

Figure 11-5. FSAVE/FNSAVE Image (32-Bit, Real/Virtual-8086 Modes)

Bit Offset		Byte Offset
31	16 15	0
Not Part of x87 State	ST(7) (79–64)	+5Ch
...		...
ST(0) (79–48)		+14h
ST(0) (47–16)		+10h
ST(0) (15–0)	Data DS Selector (15–0)	+0Ch
Data Offset (15–0)	Instruction CS Selector (15–0)	+08h
Instruction Offset (15–0)	x87 Tag Word (FTW)	+04h
x87 Status Word (FSW)	x87 Control Word (FCW)	+00h

Figure 11-6. FSAVE/FNSAVE Image (16-Bit, Protected Mode)

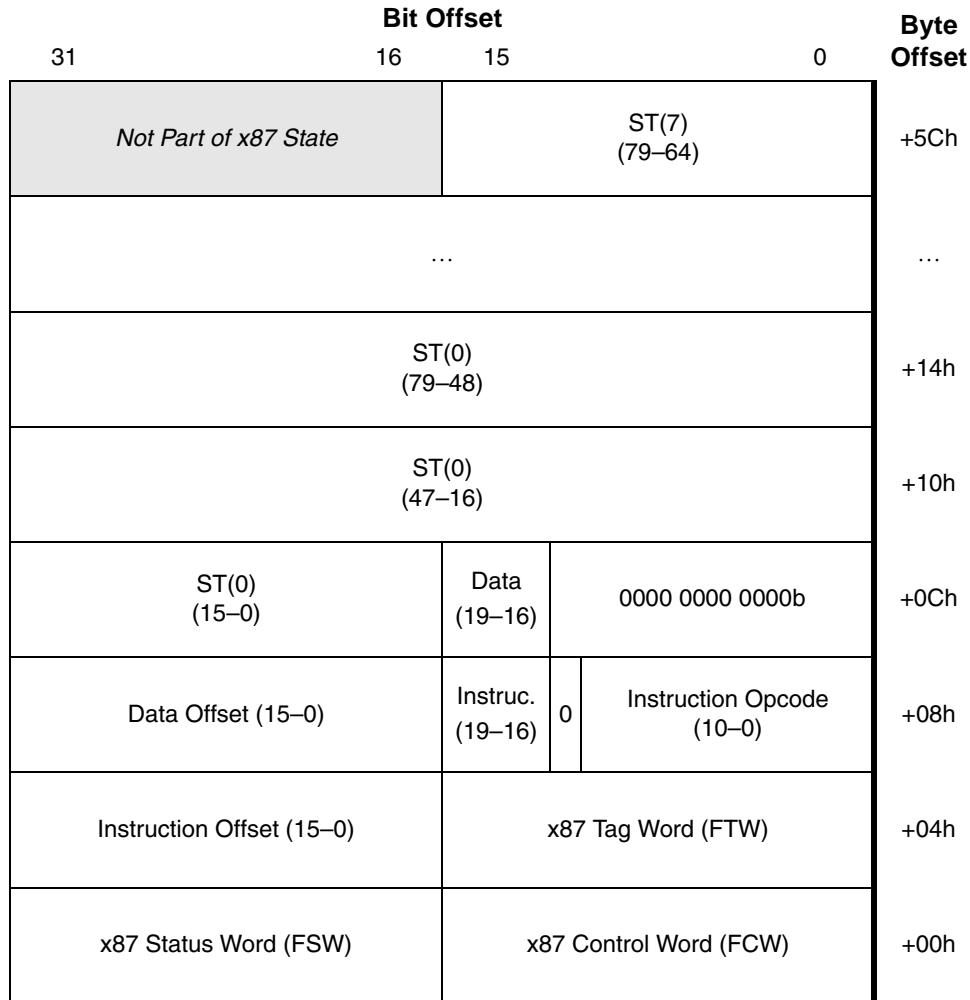

Figure 11-7. FSAVE/FNSAVE Image (16-Bit, Real/Virtual-8086 Modes)

FLDENV/FNL DENV and FSTENV Instructions. The FLDENV/FNL DENV and FSTENV instructions load and store only the x87 floating-point environment. These instructions, unlike the FSAVE/FNSAVE and FRSTOR instructions, do not save or restore the x87 data registers. The FLDENV/FSTENV instructions do not save the full 64-bit data and instruction pointers. 64-bit applications should use FXSAVE/FXRSTOR, rather than FLDENV/FSTENV. The format of the saved x87 environment images for protected mode and real/virtual mode are the same as those of the first 14-bytes of the FSAVE/FNSAVE images for 16-bit operands or 32/64-bit operands, respectively. See Figure 11-4 on page 297, Figure 11-5 on page 298, Figure 11-6 on page 299, and Figure 11-7.

FXSAVE and FXRSTOR Instructions. The FXSAVE and FXRSTOR instructions save and restore the entire 128-bit media, 64-bit media, and x87 state. These instructions usually execute faster than FSAVE/FNSAVE and FRSTOR because they do not normally save and restore the x87 exception pointers (last-instruction pointer, last data-operand pointer, and last opcode). The only case in which they do save the exception pointers is the relatively rare case in which the exception-summary bit in the

x87 status word (FSW.ES) is set to 1, indicating that an unmasked exception has occurred. The FXSAVE and FXRSTOR memory format contains fields for storing these values.

Unlike FSAVE and FNSAVE, the FXSAVE instruction does not alter the x87 tag word. Therefore, the contents of the shared 64-bit MMX and 80-bit FPR registers can remain valid after an FXSAVE instruction (or any other value the tag bits indicated before the save). Also, FXSAVE (like FNSAVE) does not check for pending unmasked-x87 floating-point exceptions.

Figure 11-8 on page 302 shows the memory format of the media x87 state in long mode. When in 64-bit mode using a 64-bit operand size, the format shown in Figure 11-8 is used. If a 32-bit operand size is used (in 64-bit mode), the memory format is the same, except that RIP and RDS are stored as *sel:offset* pointers, as shown in Figure 11-9 on page 303.

F	E	D	C	B	A	9	8	7	6	5	4	3	2	1	0	Byte
Reserved, IGN																+1F0h
...																...
Reserved, IGN																+1A0h
XMM15																+190h
XMM14																+180h
XMM13																+170h
XMM12																+160h
XMM11																+150h
XMM10																+140h
XMM9																+130h
XMM8																+120h
XMM7																+110h
XMM6																+100h
XMM5																+F0h
XMM4																+E0h
XMM3																+D0h
XMM2																+C0h
XMM1																+B0h
XMM0																+A0h
Reserved, IGN						ST(7)										+90h
Reserved, IGN						ST(6)										+80h
Reserved, IGN						ST(5)										+70h
Reserved, IGN						ST(4)										+60h
Reserved, IGN						ST(3)										+50h
Reserved, IGN						ST(2)										+40h
Reserved, IGN						ST(1)										+30h
Reserved, IGN						ST(0)										+20h
MXCSR_MASK				MXCSR				RDP ¹								+10h
RIP ¹								FOP	0	FTW	FSW	FCW	+00h			

1. Stored as sel:offset if operand size is 32 bits. 32bit sel:offset format of the pointers is shown in figure 11-9.

Figure 11-8. FXSAVE and FXRSTOR Image (64-bit Mode)

F	E	D	C	B	A	9	8	7	6	5	4	3	2	1	0	Byte
Reserved, IGN																+1F0h
...																...
Reserved, IGN																+120h
XMM7																+110h
XMM6																+100h
XMM5																+F0h
XMM4																+E0h
XMM3																+D0h
XMM2																+C0h
XMM1																+B0h
XMM0																+A0h
Reserved, IGN						ST(7)										+90h
Reserved, IGN						ST(6)										+80h
Reserved, IGN						ST(5)										+70h
Reserved, IGN						ST(4)										+60h
Reserved, IGN						ST(3)										+50h
Reserved, IGN						ST(2)										+40h
Reserved, IGN						ST(1)										+30h
Reserved, IGN						ST(0)										+20h
MXCSR_MASK				MXCSR				rsrvd, IGN		DS		DP				+10h
rsrvd, IGN		CS		EIP			FOP		0	FTW	FSW		FCW		+00h	

Figure 11-9. FXSAVE and FXRSTOR Image (Non-64-bit Mode)

Software can read and write all fields within the FXSAVE and FXRSTOR memory image. These fields include:

- *FCW*—Bytes 01h–00h. x87 control word.
- *FSW*—Bytes 03h–02h. x87 status word.
- *FTW*—Byte 04h. x87 tag word. See “FXSAVE Format for x87 Tag Word” on page 304 for additional information on the FTW format saved by the FXSAVE instruction.
- (Byte 05h contains the value 00h.)
- *FOP*—Bytes 07h–06h. last x87 opcode.
- *Last x87 Instruction Pointer*—A pointer to the last non-control x87 floating-point instruction executed by the processor:

- *RIP (64-bit format)*—Bytes 0Fh–08h. 64-bit offset into the code segment (used without a CS selector).
- *EIP (32-bit format)*—Bytes 0Bh–08h. 32-bit offset into the code segment.
- *CS (32-bit format)*—Bytes 0Dh–0Ch. Segment selector portion of the pointer.
- *Last x87 Data Pointer*—If the last non-control x87 floating point instruction referenced memory, this value is a pointer to the data operand referenced by the last non-control x87 floating-point instruction executed by the processor:
 - *RDP (64-bit format)*—Bytes 17h–10h. 64-bit offset into the data segment (used without a DS selector).
 - *DP (32-bit format)*—Bytes 13h–10h. 32-bit offset into the data segment.
 - *DS (32-bit format)*—Bytes 15h–14h. Segment selector portion of the pointer.

If the last non-control x87 instruction did not reference memory, then the value in the pointer is implementation dependent.

- *MXCSR*—Bytes 1Bh–18h. 128-bit media-instruction control and status register. This register is saved only if CR4.OSFXSR is set to 1.
- *MXCSR_MASK*—Bytes 1Fh–1Ch. Set bits in *MXCSR_MASK* indicate supported feature bits in *MXCSR*. For example, if bit 6 (the DAZ bit) in the returned *MXCSR_MASK* field is set to 1, the DAZ mode and the DAZ flag in *MXCSR* are supported. Cleared bits in *MXCSR_MASK* indicate reserved bits in *MXCSR*. If software attempts to set a reserved bit in the *MXCSR* register, a #GP exception will occur. To avoid this exception, after software clears the FXSAVE memory image and executes the FXSAVE instruction, software should use the value returned by the processor in the *MXCSR_MASK* field when writing a value to the *MXCSR* register, as follows:
 - *MXCSR_MASK* = 0: If the processor writes a zero value into the *MXCSR_MASK* field, the denormals-are-zeros (DAZ) mode and the DAZ flag in *MXCSR* are *not* supported. Software should use the default mask value, 0000_FFBFh (bit 6, the DAZ bit, and bits 31–16 cleared to 0), to mask any value it writes to the *MXCSR* register to ensure that all reserved bits in *MXCSR* are written with 0, thus avoiding a #GP exception.
 - *MXCSR_MASK* ≠ 0: If the processor writes a non-zero value into the *MXCSR_MASK* field, software should AND this value with any value it writes to the *MXCSR* register.
- *MMXn/FPRn*—Bytes 9Fh–20h. Shared 64-bit media and x87 floating-point registers. As in the case of the x87 FSAVE instruction, these registers are stored in stack order ST(0)–ST(7). The upper six bytes in the memory image for each register are reserved.
- *XMMn*—Bytes 11Fh–A0h. 128-bit media registers. These registers are saved only if CR4.OSFXSR is set to 1.

FXSAVE Format for x87 Tag Word. Rather than saving the entire x87 tag word, FXSAVE saves a single-byte encoded version. FXSAVE encodes each of the eight two-bit fields in the x87 tag word as follows:

- Two-bit values of 00, 01, and 10 are encoded as a 1, indicating the corresponding x87 *FPRn* register holds a value.

- A two-bit value of 11 is encoded as a 0, indicating the corresponding x87 FPR n is empty.

For example, assume an FSAVE instruction saves an x87 tag word with the value 83F1h. This tag-word value describes the x87 FPR n contents as follows:

x87 Register	FPR7	FPR6	FPR5	FPR4	FPR3	FPR2	FPR1	FPR0
Tag Word Value (hex)	8		3		F		1	
Tag Value (binary)	10	00	00	11	11	11	00	01
Meaning	Special	Valid	Valid	Empty	Empty	Empty	Valid	Zero

When an FXSAVE is used to write the x87 tag word to memory, it encodes the value as E3h. This encoded version describes the x87 FPR n contents as follows:

x87 Register	FPR7	FPR6	FPR5	FPR4	FPR3	FPR2	FPR1	FPR0
Encoded Tag Byte (hex)	E				3			
Tag Value (binary)	1	1	1	0	0	0	1	1
Meaning	Valid	Valid	Valid	Empty	Empty	Empty	Valid	Valid

If necessary, software can decode the single-bit FXSAVE tag-word fields into the two-bit field FSAVE uses by examining the contents of the corresponding FPR registers saved by FXSAVE. Table 11-1 on page 306 shows how the FPR contents are used to find the equivalent FSAVE tag-field value. The *fraction* column refers to fraction portion of the extended-precision significand (bits 62–0). The *integer bit* column refers to the integer-portion of the significand (bit 63). See “x87 Floating-Point Programming” in Volume 1 for more information on floating-point numbering formats.

Table 11-1. Deriving FSAVE Tag Field from FXSAVE Tag Field

Encoded FXSAVE Tag Field	Exponent	Integer Bit ²	Fraction ¹	Type of Value	Equivalent FSAVE Tag Field	
1 (Valid)	All 0s	0	All 0s	Zero	01 (Zero)	
		0	Not all 0s	Denormal	10 (Special)	
		1	All 0s	Pseudo Denormal		
		1	Not all 0s			
	Neither all 0s nor all 1s	0	don't care	Unnormal		00 (Valid)
		1		Normal		
	All 1s	0		Pseudo Infinity or Pseudo NaN	10 (Special)	
		1		All 0s		Infinity
				Not all 0s		NaN
	0 (Empty)	don't care			Empty	11 (Empty)

Note:

- Bits 62–0 of the significand. Bit 62, the most-significant bit of the fraction, is also called the M bit.
- Bit 63 of the significand, also called the J bit.

Performance Considerations. When system software supports multi-tasking, it must be able to save the processor state for one task and load the state for another. For performance reasons, the media and/or x87 processor state is usually saved and loaded only when necessary. System software can save and load this state at the time a task switch occurs. However, if the new task does not use the state, loading the state is unnecessary and reduces performance.

The task-switch bit (CR0.TS) is provided as a *lazy* context-switch mechanism that allows system software to save and load the processor state only when necessary. When CR0.TS=1, a device-not-available exception (#NM) occurs when an attempt is made to execute a 128-bit media, 64-bit media, or x87 instruction. System software can use the #NM exception handler to save the state of the previous task, and restore the state of the current task. Before returning from the exception handler to the media or x87 instruction, system software must clear CR0.TS to 0 to allow the instruction to be executed. Using this approach, the processor state is saved only when the registers are used.

In legacy mode, the hardware task-switch mechanism sets CR0.TS=1 during a task switch (see “Task Switched (TS) Bit” on page 44 for more information). In long mode, the hardware task-switching is not supported, and the CR0.TS bit is not set by the processor. Instead, the architecture assumes that system software handles all task-switching and state-saving functions. If CR0.TS is to be used in long mode for controlling the save and restore of media or x87 state, system software must set and clear it explicitly.

12 Task Management

This chapter describes the hardware task-management features. All of the legacy x86 task-management features are supported by the AMD64 architecture in legacy mode, but most features are not available in long mode. Long mode, however, requires system software to initialize and maintain certain task-management *resources*. The details of these resource-initialization requirements for long mode are discussed in “Task-Management Resources” on page 308.

12.1 Hardware Multitasking Overview

A task (also called a *process*) is a program that the processor can execute, suspend, and later resume executing at the point of suspension. During the time a task is suspended, other tasks are allowed to execute. Each task has its own execution space, consisting of:

- Code segment and instruction pointer.
- Data segments.
- Stack segments for each privilege level.
- General-purpose registers.
- rFLAGS register.
- Local-descriptor table.
- Task register, and a link to the previously-executed task.
- I/O-permission and interrupt-permission bitmaps.
- Pointer to the page-translation tables (CR3).

The state information defining this execution space is stored in the task-state segment (TSS) maintained for each task.

Support for hardware multitasking is provided in legacy mode. Hardware multitasking provides automated mechanisms for switching tasks, saving the execution state of the suspended task, and restoring the execution state of the resumed task. When hardware multitasking is used to switch tasks, the processor takes the following actions:

- Suspends execution of the task, allowing any executing instructions to complete and save their results.
- Saves the task execution state in the task TSS.
- Loads the execution state for the new task from its TSS.
- Begins executing the new task at the location specified in the new task TSS.

Software can switch tasks by branching to a new task using the CALL or JMP instructions. Exceptions and interrupts can also switch tasks if the exception or interrupt handlers are themselves separate tasks. IRET can be used to return to an earlier task.

12.2 Task-Management Resources

The hardware-multitasking features are available when protected mode is enabled (CR0.PE=1). Protected-mode software execution, by definition, occurs as part of a task. While system software is not required to use the hardware-multitasking features, it is required to initialize certain task-management resources for at least one task (the current task) when running in protected mode. This single task is needed to establish the protected-mode execution environment. The resources that must be initialized are:

- *Task-State Segment (TSS)*—A segment that holds the processor state associated with a task.
- *TSS Descriptor*—A segment descriptor that defines the task-state segment.
- *TSS Selector*—A segment selector that references the TSS descriptor located in the GDT.
- *Task Register*—A register that holds the TSS selector and TSS descriptor for the current task.

Figure 12-1 on page 309 shows the relationship of these resources to each other in both 64-bit and 32-bit operating environments.

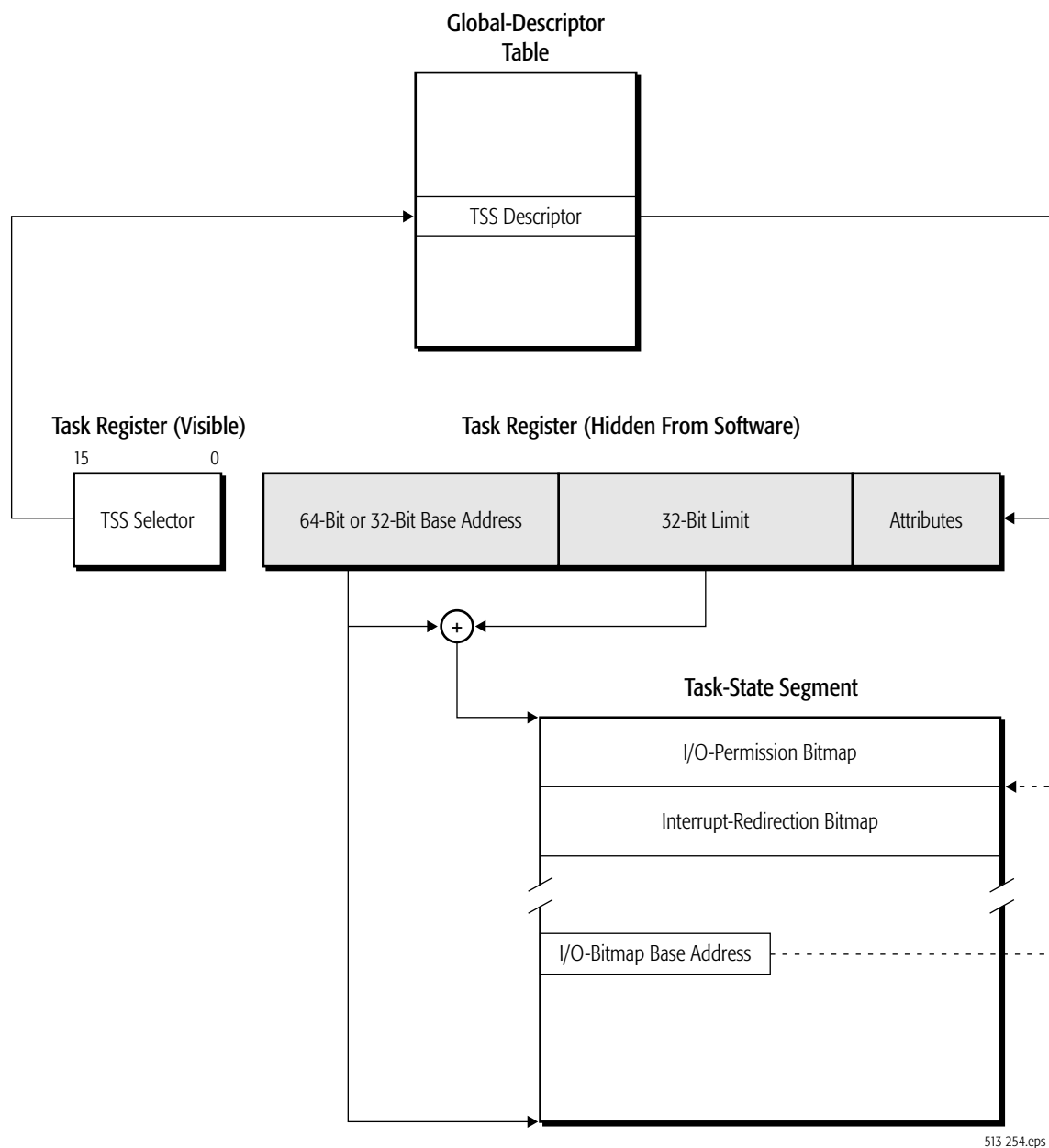

Figure 12-1. Task-Management Resources

A fifth resource is available in legacy mode for use by system software that uses the hardware-multitasking mechanism to manage more than one task:

- *Task-Gate Descriptor*—This form of gate descriptor holds a reference to a TSS descriptor and is used to control access between tasks.

The task-management resources are described in the following sections.

12.2.1 TSS Selector

TSS selectors are selectors that point to task-state segment descriptors in the GDT. Their format is identical to all other segment selectors, as shown in Figure 12-2.

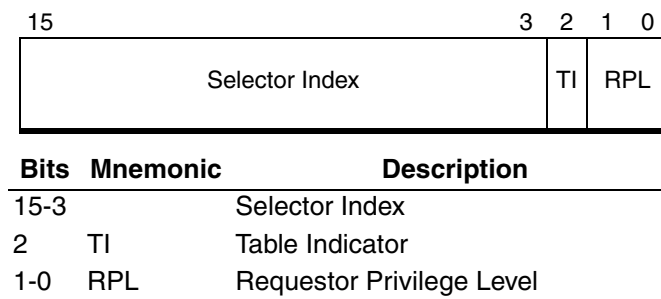

Figure 12-2. Task-Segment Selector

The selector format consists of the following fields:

Selector Index. Bits 15–3. The selector-index field locates the TSS descriptor in the global-descriptor table.

Table Indicator (TI) Bit. Bit 2. The TI bit must be cleared to 0, which indicates that the GDT is used. TSS descriptors cannot be located in the LDT. If a reference is made to a TSS descriptor in the LDT, a general-protection exception (#GP) occurs.

Requestor Privilege-Level (RPL) Field. Bits 1–0. RPL represents the privilege level (CPL) the processor is operating under at the time the TSS selector is loaded into the task register.

12.2.2 TSS Descriptor

The TSS descriptor is a system-segment descriptor, and it can be located only in the GDT. The format for an 8-byte, legacy-mode and compatibility-mode TSS descriptor can be found in “System Descriptors” on page 83. The format for a 16-byte, 64-bit mode TSS descriptor can be found in “System Descriptors” on page 88.

The fields within a TSS descriptor (all modes) are described in “Descriptor Format” on page 77. The following additional information applies to TSS descriptors:

- *Segment Limit*—A TSS descriptor must have a segment limit value of at least 67h, which defines a minimum TSS size of 68h (104 decimal) bytes. If the limit is less than 67h, an invalid-TSS exception (#TS) occurs during the task switch. When an I/O-permission bitmap, interrupt-redirection bitmap, or additional state information is included in the TSS, the limit must be set to a value large enough to enclose that information. In this case, if the TSS limit is not large enough to

hold the additional information, a #GP exception occurs when an attempt is made to access beyond the TSS limit. No check for the larger limit is performed during the task switch.

- *Type*—Four system-descriptor types are defined as TSS types, as shown in Table 4-5 on page 83. Bit 9 is used as the descriptor busy bit (B). This bit indicates that the task is busy when set to 1, and available when cleared to 0. Busy tasks are the currently running task and any previous (outer) tasks in a nested-task hierarchy. Task recursion is not supported, and a #GP exception occurs if an attempt is made to transfer control to a busy task. See “Nesting Tasks” on page 325 for additional information.

In long mode, the 32-bit TSS types (available and busy) are redefined as 64-bit TSS types, and only 64-bit TSS descriptors can be used. Loading the task register with an available 64-bit TSS causes the processor to change the TSS descriptor type to indicate a busy 64-bit TSS. Because long mode does not support task switching, the TSS-descriptor busy bit is never cleared by the processor to indicate an available 64-bit TSS.

Sixteen-bit TSS types are illegal in long mode. A general-protection exception (#GP) occurs if a reference is made to a 16-bit TSS.

12.2.3 Task Register

The *task register* (TR) points to the TSS location in memory, defines its size, and specifies its attributes. As with the other descriptor-table registers, the TR has two portions. A *visible* portion holds the TSS selector, and a *hidden* portion holds the TSS descriptor. When the TSS selector is loaded into the TR, the processor automatically loads the TSS descriptor from the GDT into the hidden portion of the TR.

The TR is loaded with a new selector using the LTR instruction. The TR is also loaded during a task switch, as described in “Switching Tasks” on page 321.

Figure 12-3 shows the format of the TR in legacy mode.

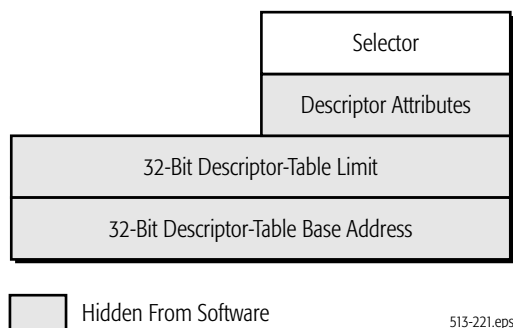

Figure 12-3. TR Format, Legacy Mode

Figure 12-4 shows the format of the TR in long mode (both compatibility mode and 64-bit mode).

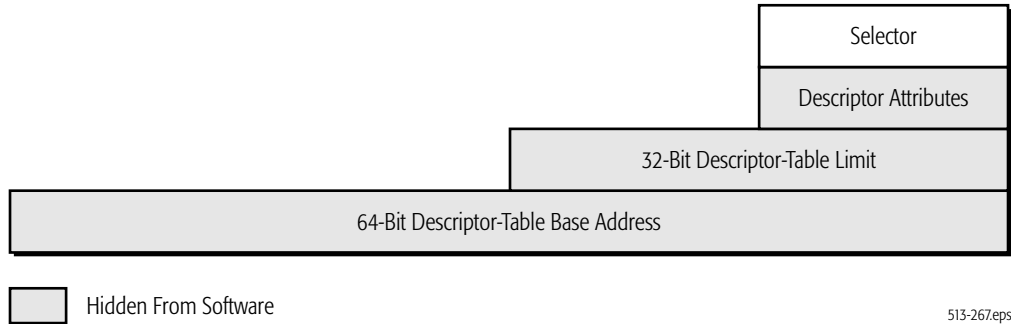

Figure 12-4. TR Format, Long Mode

The AMD64 architecture expands the TSS-descriptor base-address field to 64 bits so that system software running in long mode can access a TSS located anywhere in the 64-bit virtual-address space. The processor ignores the 32 high-order base-address bits when running in legacy mode. Because the TR is loaded from the GDT, the system-segment descriptor format has been expanded to 16 bytes by the AMD64 architecture in support of 64-bit mode. See “System Descriptors” on page 88 for more information on this expanded format. The high-order base-address bits are only loaded from 64-bit mode using the LTR instruction. Figure 12-5 shows the relationship between the TSS and GDT.

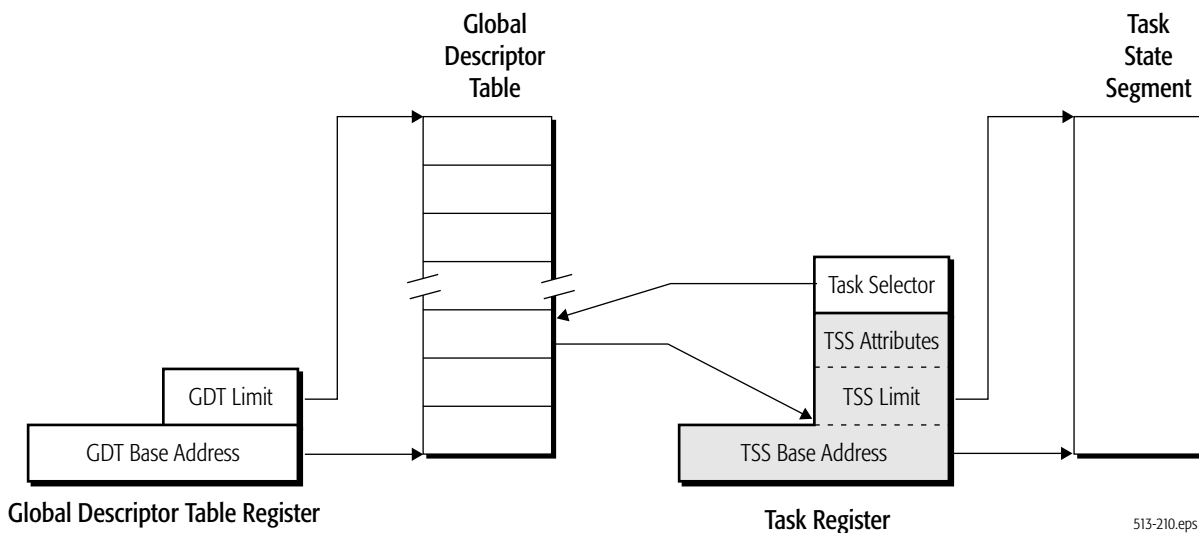

Figure 12-5. Relationship between the TSS and GDT

Long mode requires the use of a 64-bit TSS type, and this type must be loaded into the TR by executing the LTR instruction in *64-bit mode*. Executing the LTR instruction in 64-bit mode loads the TR with the full 64-bit TSS base address from the 16-byte TSS descriptor format (compatibility mode can only load 8-byte system descriptors). A processor running in either compatibility mode or 64-bit mode uses the full 64-bit TR.base address.

12.2.4 Legacy Task-State Segment

The task-state segment (TSS) is a data structure in memory that the processor uses to save and restore the execution state for a task when a task switch occurs. Figure 12-6 on page 314 shows the format of a legacy 32-bit TSS.

Bit Offset		Byte Offset
31	16 15	0
I/O-Permission Bitmap (IOPB) (Up to 8 Kbytes)		IOPB Base
Interrupt-Redirection Bitmap (IRB) (Eight 32-Bit Locations)		
↑ ↓ Operating-System Data Structure		↑ ↓
I/O-Permission Bitmap Base Address	Reserved, IGN	T +64h
Reserved, IGN	LDT Selector	+60h
Reserved, IGN	GS	+5Ch
Reserved, IGN	FS	+58h
Reserved, IGN	DS	+54h
Reserved, IGN	SS	+50h
Reserved, IGN	CS	+4Ch
Reserved, IGN	ES	+48h
EDI		+44h
ESI		+40h
EBP		+3Ch
ESP		+38h
EBX		+34h
EDX		+30h
ECX		+2Ch
EAX		+28h
EFLAGS		+24h
EIP		+20h
CR3		+1Ch
Reserved, IGN	SS2	+18h
ESP2		+14h
Reserved, IGN	SS1	+10h
ESP1		+0Ch
Reserved, IGN	SS0	+08h
ESP0		+04h
Reserved, IGN	Link (Prior TSS Selector)	+00h

Figure 12-6. Legacy 32-bit TSS

The 32-bit TSS contains three types of fields:

- *Static fields* are read by the processor during a task switch when a new task is loaded, but are not written by the processor when a task is suspended.
- *Dynamic fields* are read by the processor during a task switch when a new task is loaded, and are written by the processor when a task is suspended.
- *Software-defined fields* are read and written by software, but are not read or written by the processor. All but the first 104 bytes of a TSS can be defined for software purposes, minus any additional space required for the optional I/O-permission bitmap and interrupt-redirection bitmap.

TSS fields are not read or written by the processor when the LTR instruction is executed. The LTR instruction loads the TSS descriptor into the TR and marks the task as busy, but it does not cause a task switch.

The TSS fields used by the processor in legacy mode are:

- *Link*—Bytes 01h–00h, dynamic field. Contains a copy of the task selector from the previously-executed task. See “Nesting Tasks” on page 325 for additional information.
- *Stack Pointers*—Bytes 1Bh–04h, static field. Contains the privilege 0, 1, and 2 stack pointers for the task. These consist of the stack-segment selector (SS_n), and the stack-segment offset (ESP $_n$).
- *CR3*—Bytes 1Fh–1Ch, static field. Contains the page-translation-table base-address (CR3) register for the task.
- *EIP*—Bytes 23h–20h, dynamic field. Contains the instruction pointer (EIP) for the next instruction to be executed when the task is restored.
- *EFLAGS*—Bytes 27h–24h, dynamic field. Contains a copy of the EFLAGS image at the point the task is suspended.
- *General-Purpose Registers*—Bytes 47h–28h, dynamic field. Contains a copy of the EAX, ECX, EDX, EBX, ESP, EBP, ESI, and EDI values at the point the task is suspended.
- *Segment-Selector Registers*—Bytes 59h–48h, dynamic field. Contains a copy of the ES, CS, SS, DS, FS, and GS, values at the point the task is suspended.
- *LDT Segment-Selector Register*—Bytes 63h–60h, static field. Contains the local-descriptor-table segment selector for the task.
- *T (Trap) Bit*—Bit 0 of byte 64h, static field. This bit, when set to 1, causes a debug exception (#DB) to occur on a task switch. See “Breakpoint Instruction (INT3)” on page 340 for additional information.
- *I/O-Permission Bitmap Base Address*—Bytes 67h–66h, static field. This field represents a 16-bit offset into the TSS. This offset points to the beginning of the I/O-permission bitmap, and the end of the interrupt-redirection bitmap.
- *I/O-Permission Bitmap*—Static field. This field specifies protection for I/O-port addresses (up to the 64K ports supported by the processor), as follows:
 - Whether the port can be accessed at any privilege level.
 - Whether the port can be accessed outside the privilege level established by EFLAGS.IOPL.

- Whether the port can be accessed when the processor is running in virtual-8086 mode.

Because one bit is used per 8-byte I/O-port, this bitmap can take up to 8 Kbytes of TSS space. The bitmap can be located anywhere within the first 64 Kbytes of the TSS, as long as it is above byte 103. The last byte of the bitmap must contain all ones (0FFh). See “I/O-Permission Bitmap” on page 316 for more information.

- *Interrupt-Redirection Bitmap*—Static field. This field defines how each of the 256-possible software interrupts is directed in a virtual-8086 environment. One bit is used for each interrupt, for a total bitmap size of 32 bytes. The bitmap can be located anywhere above byte 103 within the first 64 Kbytes of the TSS. See “Interrupt Redirection of Software Interrupts” on page 250 for information on using this field.

The TSS can be paged by system software. System software that uses the hardware task-switch mechanism must guarantee that a page fault does not occur during a task switch. Because the processor only reads and writes the first 104 TSS bytes during a task switch, this restriction only applies to those bytes. The simplest approach is to align the TSS on a page boundary so that all critical bytes are either present or not present. Then, if a page fault occurs when the TSS is accessed, it occurs before the first byte is read. If the page fault occurs after a portion of the TSS is read, the fault is unrecoverable.

I/O-Permission Bitmap. The I/O-permission bitmap (IOPB) allows system software to grant less-privileged programs access to individual I/O ports, overriding the effect of RFLAGS.IOPL for those devices. When an I/O instruction is executed, the processor checks the IOPB only if the processor is in virtual x86 mode or the CPL is greater than the RFLAGS.IOPL field. Each bit in the IOPB corresponds to a byte I/O port. A word I/O port corresponds to two consecutive IOPB bits, and a doubleword I/O port corresponds to four consecutive IOPB bits. Access is granted to an I/O port of a given size when *all* IOPB bits corresponding to that port are clear. If any bits are set, a #GP occurs.

The IOPB is located in the TSS, as shown by the example in Figure 12-7 on page 317. Each TSS can have a different copy of the IOPB, so access to individual I/O devices can be granted on a task-by-task basis. The I/O-permission bitmap base-address field located at byte 66h in the TSS is an offset into the TSS locating the start of the IOPB. If all 64K IO ports are supported, the IOPB base address must not be greater than 0DFFFh, otherwise accesses to the bitmap cause a #GP to occur. An extra byte must be present after the last IOPB byte. This byte must have all bits set to 1 (0FFh). This allows the processor to read two IOPB bytes each time an I/O port is accessed. By reading two IOPB bytes, the processor can check all bits when unaligned, multi-byte I/O ports are accessed.

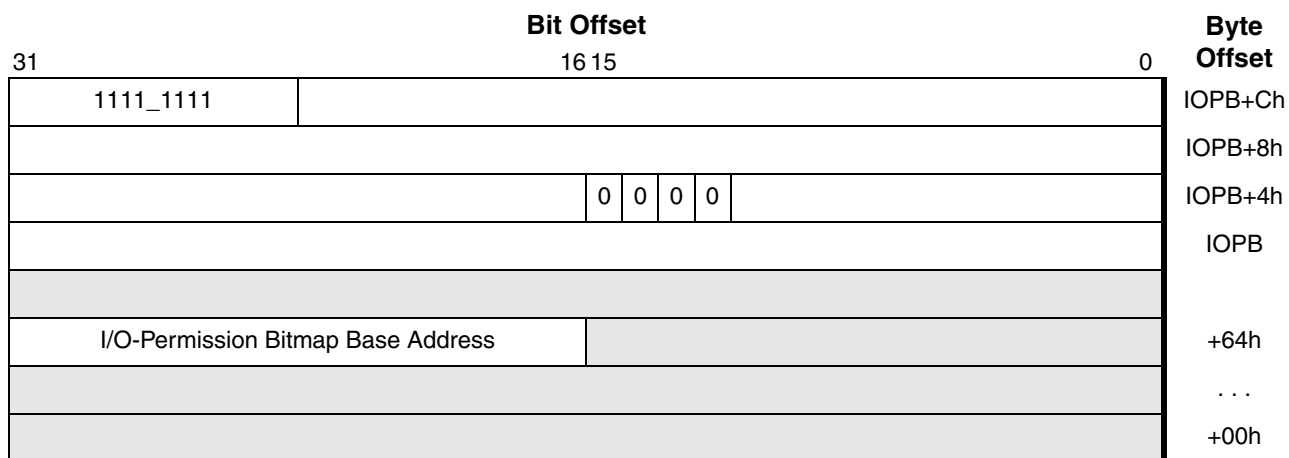

Figure 12-7. I/O-Permission Bitmap Example

Bits in the IOPB sequentially correspond to I/O port addresses. The example in Figure 12-7 shows bits 12 through 15 in the second doubleword of the IOPB cleared to 0. Those bit positions correspond to byte I/O ports 44h through 47h, or alternatively, doubleword I/O port 44h. Because the bits are cleared to zero, software running at any privilege level can access those I/O ports.

By adjusting the TSS limit, it may happen that some ports in the I/O-address space have no corresponding IOPB entry. Ports not represented by the IOPB will cause a #GP exception. Referring again to Figure 12-7, the last IOPB entry is at bit 23 in the fourth IOPB doubleword, which corresponds to I/O port 77h. In this example, all ports from 78h and above will cause a #GP exception, as if their permission bit was set to 1.

12.2.5 64-Bit Task State Segment

Although the hardware task-switching mechanism is not supported in long mode, a 64-bit task state segment (TSS) must still exist. System software must create at least one 64-bit TSS for use after activating long mode, and it must execute the LTR instruction, *in 64-bit mode*, to load the TR register with a pointer to the 64-bit TSS that serves both 64-bit-mode programs and compatibility-mode programs.

The legacy TSS contains several fields used for saving and restoring processor-state information. The legacy fields include general-purpose register, EFLAGS, CR3 and segment-selector register state, among others. Those legacy fields are not supported by the 64-bit TSS. System software must save and restore the necessary processor-state information required by the software-multitasking implementation (if multitasking is supported). Figure 12-8 on page 319 shows the format of a 64-bit TSS.

The 64-bit TSS holds several pieces of information important to long mode that are not directly related to the task-switch mechanism:

- *RSP_n*—Bytes 1Bh–04h. The full 64-bit canonical forms of the stack pointers (RSP) for privilege levels 0 through 2.

- *IST_n*—Bytes 5Bh–24h. The full 64-bit canonical forms of the interrupt-stack-table (IST) pointers. See “Interrupt-Stack Table” on page 245 for a description of the IST mechanism.
- *I/O Map Base Address*—Bytes 67h–66h. The 16-bit offset to the I/O-permission bit map from the 64-bit TSS base. The function of this field is identical to that in a legacy 32-bit TSS. See “I/O-Permission Bitmap” on page 316 for more information.

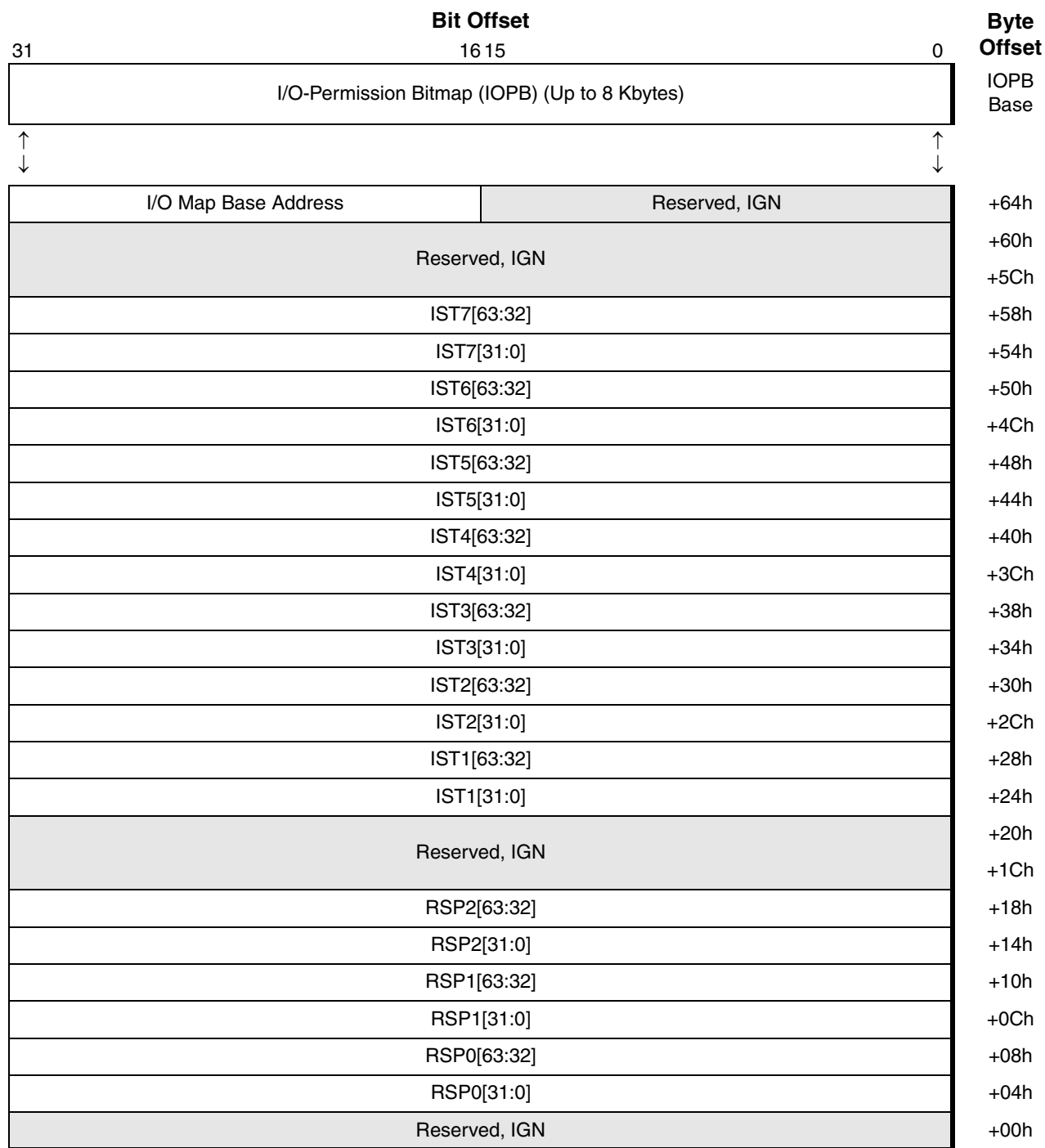

Figure 12-8. Long Mode TSS Format

12.2.6 Task Gate Descriptor (Legacy Mode Only)

Task-gate descriptors hold a selector reference to a TSS and are used to control access between tasks. Unlike a TSS descriptor or other gate descriptors, a task gate can be located in any of the three descriptor tables (GDT, LDT, and IDT). Figure 12-9 shows the format of a task-gate descriptor.

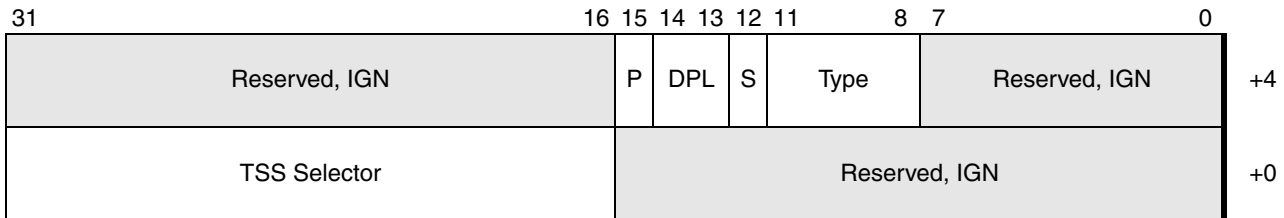

Figure 12-9. Task-Gate Descriptor, Legacy Mode Only

The task-gate descriptor fields are:

- *System (S) and Type*—Bits 12 and 11–8 (respectively) of byte +4. These bits are encoded by software as 00101b to indicate a task-gate descriptor type.
- *Present (P)*—Bit 15 of byte +4. The segment-present bit indicates the segment referenced by the gate descriptor is loaded in memory. If a reference is made to a segment when P=0, a segment-not-present exception (#NP) occurs. This bit is set and cleared by system software and is never altered by the processor.
- *Descriptor Privilege-Level (DPL)*—Bits 14–13 of byte +4. The DPL field indicates the gate-descriptor privilege level. DPL can be set to any value from 0 to 3, with 0 specifying the most privilege and 3 the least privilege.

12.3 Hardware Task-Management in Legacy Mode

This section describes the operation of the task-switch mechanism when the processor is running in legacy mode. None of these features are supported in long mode (either compatibility mode or 64-bit mode).

12.3.1 Task Memory-Mapping

The hardware task-switch mechanism gives system software a great deal of flexibility in managing the sharing and isolation of memory—both virtual (linear) and physical—between tasks.

Segmented Memory. The segmented memory for a task consists of the segments that are loaded during a task switch and any segments that are later accessed by the task code. The hardware task-switch mechanism allows tasks to either share segments with other tasks, or to access segments in isolation from one another. Tasks that share segments actually share a virtual-address (linear-address) space, but they do not necessarily share a physical-address space. When paging is enabled, the virtual-to-physical mapping for each task can differ, as is described in the following section. Shared segments

do share physical memory when paging is disabled, because virtual addresses are used as physical addresses.

A number of options are available to system software that shares segments between tasks:

- Sharing segment descriptors using the GDT. All tasks have access to the GDT, so it is possible for segments loaded in the GDT to be shared among tasks.
- Sharing segment descriptors using a single LDT. Each task has its own LDT, and that LDT selector is automatically saved and restored in the TSS by the processor during task switches. Tasks, however, can share LDTs simply by storing the same LDT selector in multiple TSSs. Using the LDT to manage segment sharing and segment isolation provides more flexibility to system software than using the GDT for the same purpose.
- Copying shared segment descriptors into multiple LDTs. Segment descriptors can be copied by system software into multiple LDTs that are otherwise not shared between tasks. Allowing segment sharing at the segment-descriptor level, rather than the LDT level or GDT level, provides the greatest flexibility to system software.

In all three cases listed above, the actual data and instructions are shared between tasks only when the tasks' virtual-to-physical address mappings are identical.

Paged Memory. Each task has its own page-translation table base-address (CR3) register, and that register is automatically saved and restored in the TSS by the processor during task switches. This allows each task to point to its own set of page-translation tables, so that each task can translate virtual addresses to physical addresses independently. Page translation must be enabled for changes in CR3 values to have an effect on virtual-to-physical address mapping. When page translation is disabled, the tables referenced by CR3 are ignored, and virtual addresses are equivalent to physical addresses.

12.3.2 Switching Tasks

The hardware task-switch mechanism transfers program control to a new task when any of the following occur:

- A CALL or JMP instruction with a selector operand that references a task gate is executed. The task gate can be located in either the LDT or GDT.
- A CALL or JMP instruction with a selector operand that references a TSS descriptor is executed. The TSS descriptor must be located in the GDT.
- A software-interrupt instruction (INT n) is executed that references a task gate located in the IDT.
- An exception or external interrupt occurs, and the vector references a task gate located in the IDT.
- An IRET is executed while the EFLAGS.NT bit is set to 1, indicating that a return is being performed from an inner-level task to an outer-level task. The new task is referenced using the selector stored in the current-task link field. See “Nesting Tasks” on page 325 for additional information. The RET instruction *cannot* be used to switch tasks.

When a task switch occurs, the following operations are performed automatically by the processor:

- The processor performs privilege-checking to determine whether the currently-executing program is allowed to access the target task. If this check fails, the task switch is aborted without modifying the processor state, and a general-protection exception (#GP) occurs. The privilege checks performed depend on the cause of the task switch:
 - If the task switch is initiated by a CALL or JMP instruction through a TSS descriptor, the processor checks that both the currently-executing program CPL and the TSS-selector RPL are numerically less-than or equal-to the TSS-descriptor DPL.
 - If the task switch takes place through a task gate, the CPL and task-gate RPL are compared with the task-gate DPL, and no comparison is made using the TSS-descriptor DPL. See “Task Switches Using Task Gates” on page 323.
 - Software interrupts, hardware interrupts, and exceptions all transfer control without checking the task-gate DPL.
 - The IRET instruction transfers control without checking the TSS-descriptor DPL.
- The processor performs limit-checking on the target TSS descriptor to verify that the TSS limit is greater than or equal to 67h (at least 104 bytes). If this check fails, the task switch is aborted without modifying the processor state, and an invalid-TSS exception (#TS) occurs.
- The current-task state is saved in the TSS. This includes the next-instruction pointer (EIP), EFLAGS, the general-purpose registers, and the segment-selector registers.

Up to this point, any exception that occurs aborts the task switch without changing the processor state. From this point forward, any exception that occurs does so in the context of the new task. If an exception occurs in the context of the new task during a task switch, the processor finishes loading the new-task state without performing additional checks. The processor transfers control to the #TS handler after this state is loaded, but before the first instruction is executed in the new task. When a #TS occurs, it is possible that some of the state loaded by the processor did not participate in segment access checks. The #TS handler must verify that all segments are accessible before returning to the interrupted task.

- The task register (TR) is loaded with the new-task TSS selector, and the hidden portion of the TR is loaded with the new-task descriptor. The TSS now referenced by the processor is that of the new task.
- The current task is marked as busy. The previous task is marked as available or remains busy, based on the type of linkage. See “Nesting Tasks” on page 325 for more information.
- CR0.TS is set to 1. This bit can be used to save other processor state only when it becomes necessary. For more information, see the next section, “Saving Other Processor State.”
- The new-task state is loaded from the TSS. This includes the next-instruction pointer (EIP), EFLAGS, the general-purpose registers, and the segment-selector registers. The processor clears the segment-descriptor present (P) bits (in the hidden portion of the segment registers) to prevent access into the new segments, until the task switch completes successfully.
- The LDTR and CR3 registers are loaded from the TSS, changing the virtual-to-physical mapping from that of the old task to the new task. Because this is done in the middle of accessing the new TSS, system software must guarantee that TSS addresses are translated identically in all tasks.

- The descriptors for all previously-loaded segment selectors are loaded into the hidden portion of the segment registers. This sets or clears the P bits for the segments as specified by the new descriptor values.

If the above steps complete successfully, the processor begins executing instructions in the new task beginning with the instruction referenced by the CS:EIP far pointer loaded from the new TSS. The privilege level of the new task is taken from the new CS segment selector's RPL.

Saving Other Processor State. The processor does not automatically save the registers used by the media or x87 instructions. Instead, the processor sets CR0.TS to 1 during a task switch. Later, when an attempt is made to execute any of the media or x87 instructions while TS=1, a device-not-available exception (#NM) occurs. System software can then save the previous state of the media and x87 registers and clear the CR0.TS bit to 0 before executing the next media/x87 instruction. As a result, the media and x87 registers are saved only when necessary after a task switch.

12.3.3 Task Switches Using Task Gates

When a control transfer to a new task occurs through a task gate, the processor reads the task-gate DPL (DPL_G) from the task-gate descriptor. Two privilege checks, both of which must pass, are performed on DPL_G before the task switch can occur successfully:

- The processor compares the CPL with DPL_G . The CPL must be numerically *less than or equal to* DPL_G for this check to pass. In other words, the following expression must be true: $CPL \leq DPL_G$.
- The processor compares the RPL in the task-gate selector with DPL_G . The RPL must be numerically *less than or equal to* DPL_G for this check to pass. In other words, the following expression must be true: $RPL \leq DPL_G$.

Unlike call-gate control transfers, the processor does not read the DPL from the target TSS descriptor (DPL_S) and compare it with the CPL when a task gate is used.

Figure 12-10 on page 324 shows two examples of task-gate privilege checks. In Example 1, the privilege checks pass:

- The task-gate DPL (DPL_G) is at the lowest privilege (3), specifying that software running at any privilege level (CPL) can access the gate.
- The selector referencing the task gate passes its privilege check because the RPL is numerically less than or equal to DPL_G .

In Example 2, both privilege checks fail:

- The task-gate DPL (DPL_G) specifies that only software at privilege-level 0 can access the gate. The current program does not have enough privilege to access the task gate, because its CPL is 2.
- The selector referencing the task-gate descriptor does not have a high enough privilege to complete the reference. Its RPL is numerically greater than DPL_G .

Although both privilege checks failed in the example, if only one check fails, access into the target task is denied.

Because the legacy task-switch mechanism is not supported in long mode, *software cannot use task gates in long mode*. Any attempt to transfer control to another task using a task gate in long mode causes a general-protection exception (#GP) to occur.

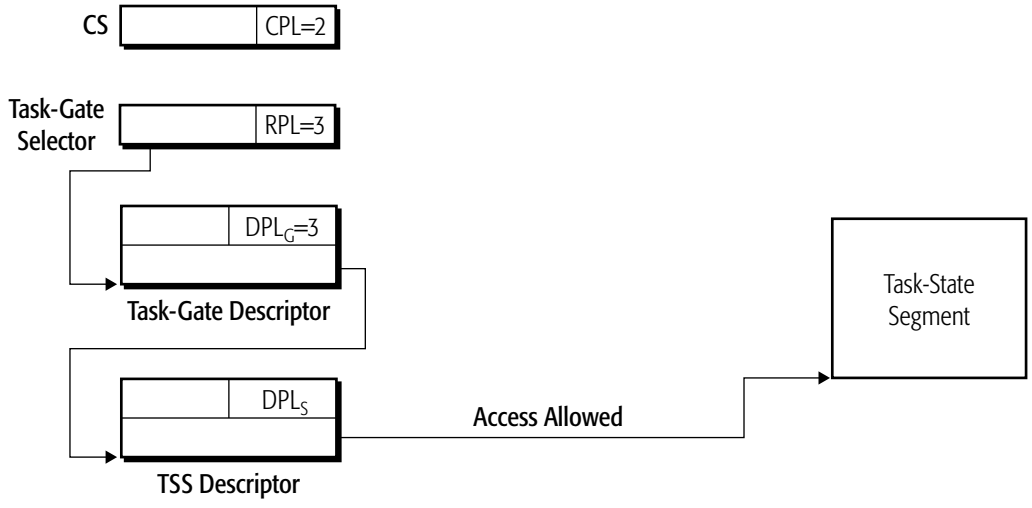

Example 1: Privilege Check Passes

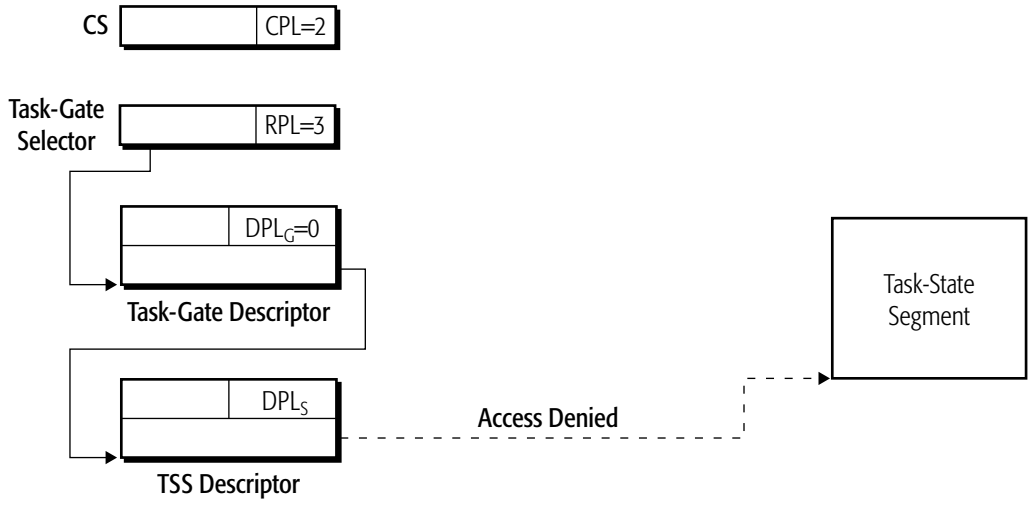

Example 2: Privilege Check Fails

513-255.eps

Figure 12-10. Privilege-Check Examples for Task Gates

12.3.4 Nesting Tasks

The hardware task-switch mechanism supports task nesting through the use of EFLAGS *nested-task* (NT) bit and the TSS link-field. The manner in which these fields are updated and used during a task switch depends on how the task switch is initiated:

- The JMP instruction does not update EFLAGS.NT or the TSS link-field. Task nesting is not supported by the JMP instruction.
- The CALL instruction, INT n instructions, interrupts, and exceptions can only be performed from outer-level tasks to inner-level tasks. All of these operations set the EFLAGS.NT bit for the new task to 1 during a task switch, and copy the selector for the previous task into the new-task link field.
- An IRET instruction which returns to another task only occurs when the EFLAGS.NT bit for the current task is set to 1, and only can be performed from an inner-level task to an outer-level task. When an IRET results in a task switch, the new task is referenced using the selector stored in the current-TSS link field. The EFLAGS.NT bit for the current task is cleared to 0 during the task switch.

Table 12-1 summarizes the effect various task-switch initiators have on EFLAGS.NT, the TSS link-field, and the TSS-busy bit. (For more information on the busy bit, see the next section, “Preventing Recursion.”)

Table 12-1. Effects of Task Nesting

Task-Switch Initiator	Old Task			New Task		
	EFLAGS.NT	Link (Selector)	Busy	EFLAGS.NT	Link (Selector)	Busy
JMP	—	—	Clear to 0 (was 1)	—	—	Set to 1
CALL INT n Interrupt Exception	—	—	— (Was 1)	Set to 1	Old Task	Set to 1
IRET	Clear to 0 (was 1)	—	Clear to 0 (was 1)	—	—	—

Note:
“—” indicates no change is made.

Programs running at any privilege level can set EFLAGS.NT to 1 and execute the IRET instruction to transfer control to another task. System software can keep control over improperly nested-task switches by initializing the link field of all TSSs that it creates. That way, improperly nested-task switches always transfer control to a known task.

Preventing Recursion. Task recursion is not allowed by the hardware task-switch mechanism. If recursive-task switches were allowed, they would replace a previous task-state image with a newer image, discarding the previous information. To prevent recursion from occurring, the processor uses

the busy bit located in the TSS-descriptor type field (bit 9 of byte +4). Use of this bit depends on how the task switch is initiated:

- The JMP instruction clears the busy bit in the old task to 0 and sets the busy bit in the new task to 1. A general-protection exception (#GP) occurs if an attempt is made to JMP to a task with a set busy bit.
- The CALL instruction, INT n instructions, interrupts, and exceptions set the busy bit in the new task to 1. The busy bit in the old task remains set to 1, preventing recursion through task-nesting levels. A general-protection exception (#GP) occurs if an attempt is made to switch to a task with a set busy bit.
- An IRET to another task (EFLAGS.NT must be 1) clears the busy bit in the old task to 0. The busy bit in the new task is not altered, because it was already set to 1.

Table 12-1 on page 325 summarizes the effect various task-switch initiators have on the TSS-busy bit.

13 Debug and Performance Resources

Testing, debug, and performance optimization consume a significant portion of the time needed to develop a new computer or software product and move it successfully into production. To stay competitive, product developers need tools that allow them to rapidly detect, isolate, and correct problems before a product is shipped. The goal of the debug and performance features incorporated into processor implementations of the AMD64 architecture is to support the tool chain solutions used in software-product and hardware-product development.

The debug and performance resources that can be supported by AMD64 architecture implementations include:

- *Software Debug*—The AMD64 architecture supports the legacy software-debug facilities, including the debug registers (DR0–DR7), debug exception, and breakpoint exception. Additional features are provided using model-specific registers (MSRs). These registers are used to set breakpoints on branches, interrupts, and exceptions and to single step from one branch to the next. The software-debug capability is described in “Software-Debug Resources” on page 327.
- *Performance Monitoring*—Model-specific registers (MSRs) are provided to monitor events within an implementation of the AMD64 architecture. A set of control registers allow the selection of events to be monitored and a corresponding set of counter registers track the frequency of monitored events. These features are used to support software-performance and hardware-performance tuning. Performance monitoring is described in “Performance Optimization” on page 341.

A given processor implementation may include additional debug capabilities that allow monitoring program execution and manipulation of processor state to be manipulated. These resources are typically intended for BIOS and platform development and, if available, are described in the BIOS and Kernel Developer’s Guide for AMD Athlon™ 64 and AMD Opteron™ Processors (order# 26094) for information specific to a particular processor.

13.1 Software-Debug Resources

Software can program breakpoints into the debug registers, causing a #DB exception when matches occur on instruction-memory addresses, data-memory addresses, or I/O addresses. The breakpoint exception (#BP) is also supported to allow software to set breakpoints by placing INT3 instructions in the instruction memory for a program. Program control is transferred to the breakpoint exception (#BP) handler when an INT3 instruction is executed.

In addition to the debug features supported by the debug registers (DR0–DR7), the processor also supports features supported by model-specific registers (MSRs). Together, these capabilities provide a rich set of breakpoint conditions, including:

- *Breakpoint On Address Match*—Breakpoints occur when the address stored in a address-breakpoint register matches the address of an instruction or data reference. Up to four address-match breakpoint conditions can be set by software.
- *Single Step All Instructions*—Breakpoints can be set to occur on every instruction, allowing a debugger to examine the contents of registers as a program executes.
- *Single Step Control Transfers*—Breakpoints can be set to occur on control transfers, such as calls, jumps, interrupts, and exceptions. This can allow a debugger to narrow a problem search to a specific section of code before enabling single stepping of all instructions.
- *Breakpoint On Any Instruction*—Breakpoints can be set on any specific instruction using either the address-match breakpoint condition or using the INT3 instruction to force a breakpoint when the instruction is executed.
- *Breakpoint On Task Switch*—Software forces a #DB exception to occur when a task switch is performed to a task with the T bit in the TSS set to 1. Debuggers can use this capability to enable or disable debug conditions for a specific task.

Problem areas can be identified rapidly using the information supplied by the debug registers when breakpoint conditions occur:

- Special conditions that cause a #DB exception are recorded in the DR6 debug-status register, including breakpoints due to task switches and single stepping. The DR6 register also identifies which address-breakpoint register (DR0–DR3) caused a #DB exception due to an address match. When combined with the DR7 debug-control register settings, the cause of a #DB exception can be identified.
- To assist in analyzing the instruction sequence a processor follows in reaching its current state, the source and destination addresses of control-transfer events are saved by the processor. These include branches (calls and jumps), interrupts, and exceptions. Debuggers can use this information to narrow a problem search to a specific section of code before single stepping all instructions.

13.1.1 Debug Registers

The AMD64 architecture supports the legacy debug registers, DR0–DR7. These registers are expanded to 64 bits by the AMD64 architecture. In legacy mode and in compatibility mode, only the lower 32 bits are used. In these modes, writes to a debug register fill the upper 32 bits with zeros, and reads from a debug register return only the lower 32 bits. In 64-bit mode, all 64 bits of the debug registers are read and written. Operand-size prefixes are ignored.

The debug registers can be read and written only when the current-protection level (CPL) is 0 (most privileged). Attempts to read or write the registers at a lower-privilege level (CPL>0) cause a general-protection exception (#GP).

Several debug registers described below are model-specific registers (MSRs). See “Software-Debug MSRs” on page 467 for a listing of the debug-MSR numbers and their reset values. Some processor implementations include additional MSRs used to support implementation-specific software debug features. For more information on these registers and their capabilities, refer to the BIOS writer’s guide for the implementation.

Address-Breakpoint Registers (DR0-DR3). Figure 13-1 shows the format of the four address-breakpoint registers, DR0-DR3. Software can load a virtual (linear) address into any of the four registers, and enable breakpoints to occur when the address matches an instruction or data reference. The MOV DR*n* instructions *do not* check that the virtual addresses loaded into DR0–DR3 are in canonical form. Breakpoint conditions are enabled using the debug-control register, DR7 (see “Debug-Control Register (DR7)” on page 331).

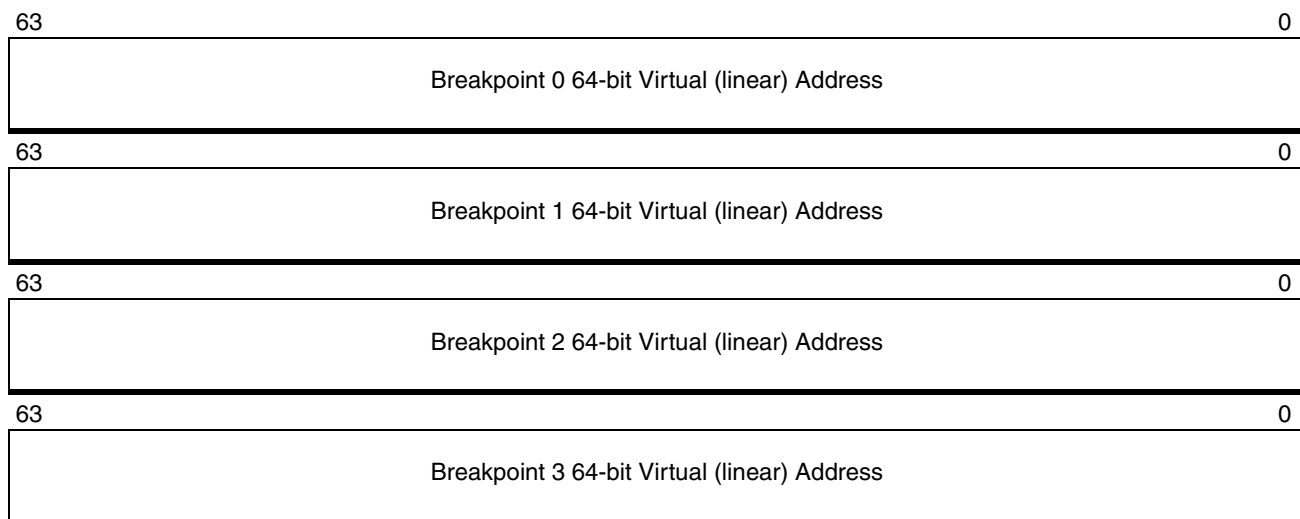
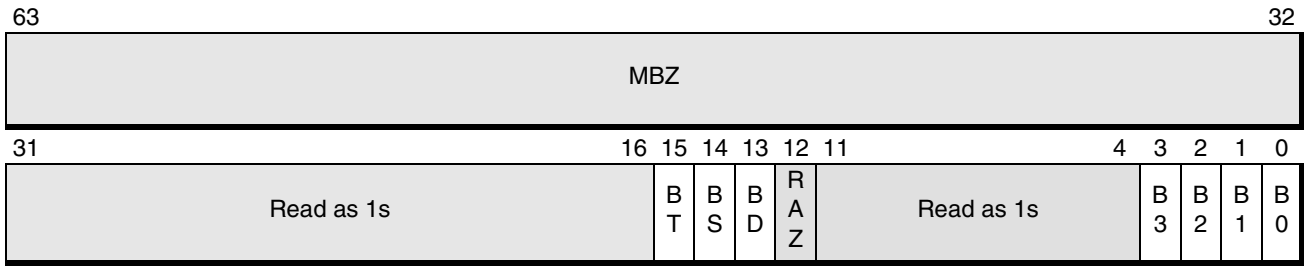

Figure 13-1. Address-Breakpoint Registers (DR0–DR3)

Reserved Debug Registers (DR4, DR5). The DR4 and DR5 registers are reserved and should not be used by software. These registers are aliased to the DR6 and DR7 registers, respectively. When the debug extensions are enabled (CR4.DE=1) attempts to access these registers cause an invalid-opcode exception (#UD).

Debug-Status Register (DR6). Figure 13-2 on page 330 shows the format of the debug-status register, DR6. Debug status is loaded into DR6 when an enabled debug condition is encountered that causes a #DB exception.



Bits	Mnemonic	Description	R/W
63–16	Reserved	MBZ	
15	BT	Breakpoint Task Switch	R/W
14	BS	Breakpoint Single Step	R/W
13	BD	Breakpoint Debug Access Detected	R/W
12	Reserved	Read as Zero	
11–4	Reserved	Read as 1s	
3	B3	Breakpoint #3 Condition Detected	R/W
2	B2	Breakpoint #2 Condition Detected	R/W
1	B1	Breakpoint #1 Condition Detected	R/W
0	B0	Breakpoint #0 Condition Detected	R/W

Figure 13-2. Debug-Status Register (DR6)

Bits 15:13 of the DR6 register is never cleared by the processor and must be cleared by software after the contents have been read. Register fields are:

- *Breakpoint-Condition Detected (B3–B0)*—Bits 3–0. The processor updates these four bits on every debug breakpoint or general-detect condition. A bit is set to 1 if the corresponding address-breakpoint register detects an enabled breakpoint condition, as specified by the DR7 L_n , G_n , R/W_n and LEN_n controls, and is cleared to 0 otherwise. For example, B1 (bit 1) is set to 1 if an address-breakpoint condition is detected by DR1.
- *Debug-Register-Access Detected (BD)*—Bit 13. The processor sets this bit to 1 if software accesses any debug register (DR0–DR7) while the general-detect condition is enabled (DR7.GD=1).
- *Single Step (BS)*—Bit 14. The processor sets this bit to 1 if the #DB exception occurs as a result of single-step mode (rFLAGS.TF=1). Single-step mode has the highest-priority among debug exceptions. Other status bits within the DR6 register can be set by the processor along with the BS bit.
- *Task-Switch (BT)*—Bit 15. The processor sets this bit to 1 if the #DB exception occurred as a result of task switch to a task with a TSS T-bit set to 1.

All remaining bits in the DR6 register are reserved. Reserved bits 31–16 and 11–4 must all be set to 1, while reserved bit 12 must be cleared to 0. In 64-bit mode, the upper 32 bits of DR6 are reserved and must be written with zeros. Writing a 1 to any of the upper 32 bits results in a general-protection exception, #GP(0).

Debug-Control Register (DR7). Figure 13-3 shows the format of the debug-control register, DR7. DR7 is used to establish the breakpoint conditions for the address-breakpoint registers (DR0–DR3) and to enable debug exceptions for each address-breakpoint register individually. DR7 is also used to enable the general-detect breakpoint condition.

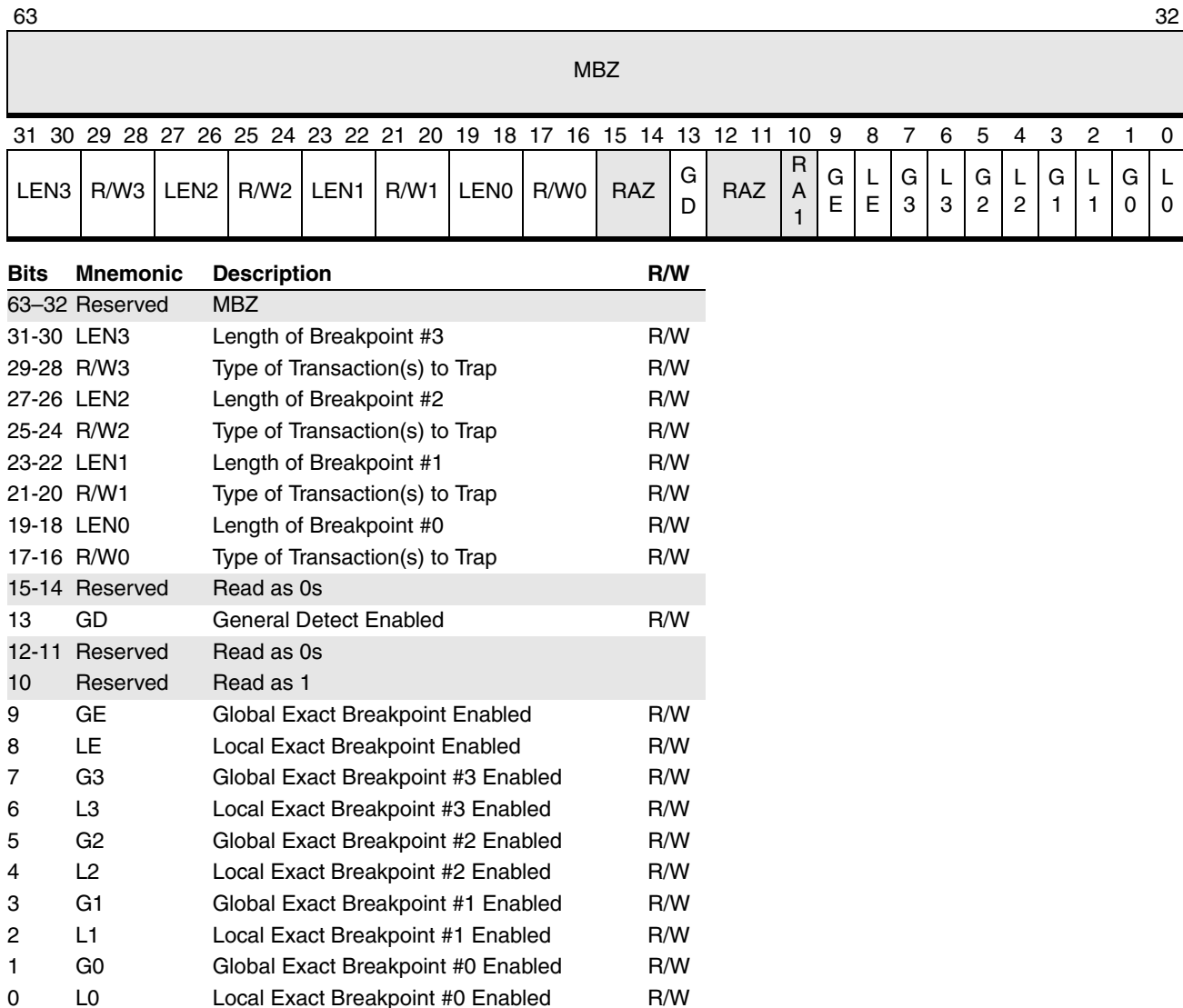

Figure 13-3. Debug-Control Register (DR7)

The fields within the DR7 register are all read/write. These fields are:

- *Local-Breakpoint Enable (L3–L0)*—Bits 6, 4, 2, and 0 (respectively). Software individually sets these bits to 1 to enable debug exceptions to occur when the corresponding address-breakpoint register (DR n) detects a breakpoint condition while executing the *current* task. For example, if L1

(bit 2) is set to 1 and an address-breakpoint condition is detected by DR1, a #DB exception occurs. These bits are cleared to 0 by the processor when a hardware task-switch occurs.

- *Global-Breakpoint Enable (G3–G0)*—Bits 7, 5, 3, and 1 (respectively). Software sets these bits to 1 to enable debug exceptions to occur when the corresponding address-breakpoint register (DR n) detects a breakpoint condition while executing *any* task. For example, if G1 (bit 3) is set to 1 and an address-breakpoint condition is detected by DR1, a #DB exception occurs. These bits are never cleared to 0 by the processor.
- *Local-Enable (LE)*—Bit 8. Software sets this bit to 1 in legacy implementations to enable exact breakpoints while executing the *current* task. This bit is ignored by implementations of the AMD64 architecture. All breakpoint conditions, except certain string operations preceded by a repeat prefix, are exact.
- *Global-Enable (GE)*—Bit 9. Software sets this bit to 1 in legacy implementations to enable exact breakpoints while executing *any* task. This bit is ignored by implementations of the AMD64 architecture. All breakpoint conditions, except certain string operations preceded by a repeat prefix, are exact.
- *General-Detect Enable (GD)*—Bit 13. Software sets this bit to 1 to cause a debug exception to occur when an attempt is made to execute a MOV DR n instruction to any debug register (DR0–DR7). This bit is cleared to 0 by the processor when the #DB handler is entered, allowing the handler to read and write the DR n registers. The #DB exception occurs before executing the instruction, and DR6.BD is set by the processor. Software debuggers can use this bit to prevent the currently-executing program from interfering with the debug operation.
- *Read/Write (R/W3–R/W0)*—Bits 29–28, 25–24, 21–20, and 17–16 (respectively). Software sets these fields to control the breakpoint conditions used by the corresponding address-breakpoint registers (DR n). For example, control-field R/W1 (bits 21–20) controls the breakpoint conditions for the DR1 register. The R/W n control-field encodings specify the following conditions for an address-breakpoint to occur:
 - 00—Only on instruction execution.
 - 01—Only on data write.
 - 10—This encoding is further qualified by CR4.DE as follows:
 - . CR4.DE=0—Condition is undefined.
 - . CR4.DE=1—Only on I/O read or I/O write.
 - 11—Only on data read or data write.
- *Length (LEN3–LEN0)*—Bits 31–30, 27–26, 23–22, and 19–18 (respectively). Software sets these fields to control the range used in comparing a memory address with the corresponding address-breakpoint register (DR n). For example, control-field LEN1 (bits 23–22) controls the breakpoint-comparison range for the DR1 register.

The value in DR n defines the low-end of the address range used in the comparison. LEN n is used to mask the low-order address bits in the corresponding DR n register so that they are not used in the address comparison. To work properly, breakpoint boundaries must be aligned on an address

corresponding to the range size specified by LEN_n . The LEN_n control-field encodings specify the following address-breakpoint-comparison ranges:

- 00—1 byte.
- 01—2 byte, must be aligned on a word boundary.
- 10—8 byte, must be aligned on a quadword boundary. (Long mode only; otherwise undefined.)
- 11—4 byte, must be aligned on a doubleword boundary.

If the R/W_n field is used to specify instruction breakpoints ($R/W_n=00$), the corresponding LEN_n field must be set to 00. Setting LEN_n to any other value produces undefined results.

All remaining bits in the DR7 register are reserved. Reserved bits 15–14 and 12–11 must all be cleared to 0, while reserved bit 10 must be set to 1. In 64-bit mode, the upper 32 bits of DR7 are reserved and must be written with zeros. Writing a 1 to any of the upper 32 bits results in a general-protection #GP(0) exception.

64-Bit-Mode Extended Debug Registers. In 64-bit mode, additional encodings for debug registers are available. The REX.R bit, in a REX prefix, is used to modify the ModRM *reg* field when that field encodes a control register, as shown in “REX Prefixes” in Volume 3. These additional encodings enable the processor to address DR8–DR15.

Access to the DR8–DR15 registers is implementation-dependent. The architecture does not require any of these extended debug registers to be implemented. Any attempt to access an unimplemented register results in an invalid-opcode exception (#UD).

Debug-Control MSR (DebugCtlMSR). Figure 13-4 on page 334 shows the format of the debug-control MSR, DebugCtlMSR. DebugCtlMSR provides additional debug controls over control-transfer recording and single stepping, and external-breakpoint reporting and trace messages. DebugCtlMSR is an MSR and is read and written using the RDMSR and WRMSR instructions.



Bits	Mnemonic	Description	R/W
63-6	Reserved		
5	PB3	Performance Monitoring Pin Control	R/W
4	PB2	Performance Monitoring Pin Control	R/W
3	PB1	Performance Monitoring Pin Control	R/W
2	PB0	Performance Monitoring Pin Control	R/W
1	BTF	Branch Single Step	R/W
0	LBR	Last-Branch Record	R/W

Figure 13-4. Debug-Control MSR (DebugCtlMSR)

The fields within the DebugCtlMSR register are:

- *Last-Branch Record (LBR)*—Bit 0, read/write. Software sets this bit to 1 to cause the processor to record the source and target addresses of the last control transfer taken before a debug exception occurs. The recorded control transfers include branch instructions, interrupts, and exceptions. See “Control-Transfer Breakpoint Features” on page 340 for more details on the registers. See Figure 13-5 on page 335 for the format of the control-transfer recording MSR's.
- *Branch Single Step (BTF)*—Bit 1, read/write. Software uses this bit to change the behavior of the rFLAGS.TF bit. When this bit is cleared to 0, the rFLAGS.TF bit controls instruction single stepping, (normal behavior). When this bit is set to 1, the rFLAGS.TF bit controls single stepping on control transfers. The single-stepped control transfers include branch instructions, interrupts, and exceptions. Control-transfer single stepping requires both BTF=1 and rFLAGS.TF=1. See “Control-Transfer Breakpoint Features” on page 340 for more details on control-transfer single stepping.
- *Performance-Monitoring/Breakpoint Pin-Control (PBi)*—Bits 5–2, read/write. Software uses these bits to control the type of information reported by the four external performance-monitoring/breakpoint pins on the processor. When a PB_i bit is cleared to 0, the corresponding external pin (BP_i) reports performance-monitor information. When a PB_i bit is set to 1, the corresponding external pin (BP_i) reports breakpoint information.

All remaining bits in the DebugCtlMSR register are reserved.

Control-Transfer Recording MSRs. Figure 13-5 on page 335 shows the format of the 64-bit control-transfer recording MSRs: LastBranchToIP, LastBranchFromIP, LastExceptionToIP, and

LastExceptionFromIP. These registers are loaded automatically by the processor when the DebugCtlMSR.LBR bit is set to 1. These MSR registers are read-only.

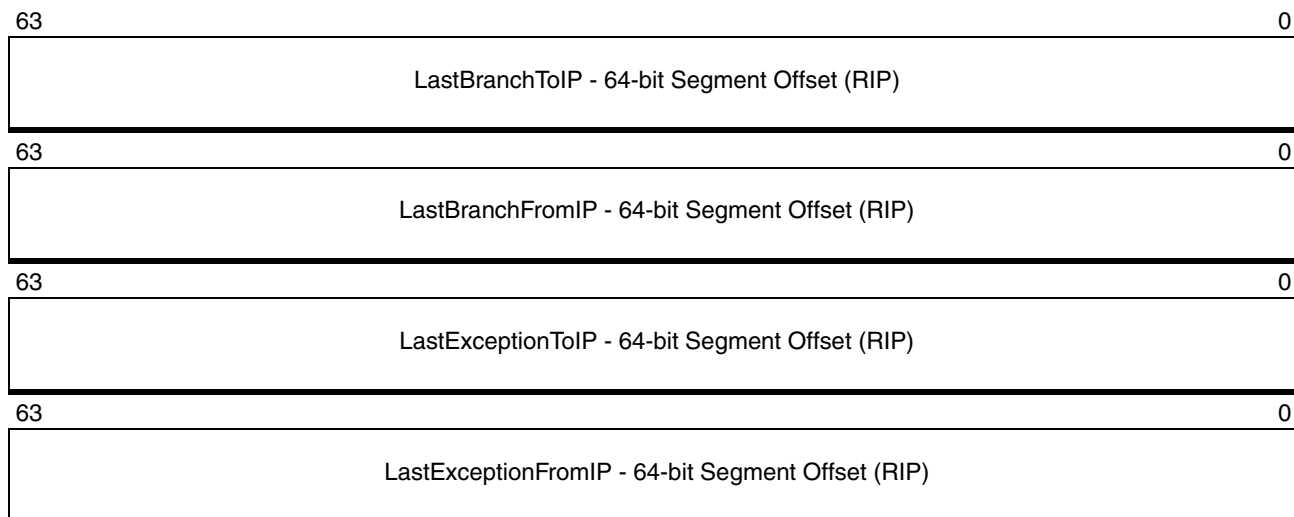

Figure 13-5. Control-Transfer Recording MSRs

13.2 Breakpoints

13.2.1 Setting Breakpoints

Breakpoints can be set to occur on either instruction addresses or data addresses using the breakpoint-address registers, DR0–DR3 (DR_n). The values loaded into these registers represent the breakpoint-location virtual address. The debug-control register, DR7, is used to enable the breakpoint registers and to specify the type of access and the range of addresses that can trigger a breakpoint.

Software enables the DR_n registers using the corresponding local-breakpoint enable (Ln) or global-breakpoint enable (Gn) found in the DR7 register. Ln is used to enable breakpoints only while the current task is active, and it is cleared by the processor when a task switch occurs. Gn is used to enable breakpoints for all tasks, and it is never cleared by the processor.

The R/W_n fields in DR7, along with the CR4.DE bit, specify the type of access required to trigger a breakpoint when an address match occurs on the corresponding DR_n register. Breakpoints can be set to occur on instruction execution, data reads and writes, and I/O reads and writes. The R/W_n and CR4.DE encodings used to specify the access type are described on page 332 of “Debug-Control Register (DR7).”

The LEN_n fields in DR7 specify the size of the address range used in comparison with data or instruction addresses. LEN_n is used to mask the low-order address bits in the corresponding DR_n register so that they are not used in the address comparison. Breakpoint boundaries must be aligned on an address corresponding to the range size specified by LEN_n . Assuming the access type matches the type specified by R/W_n , a breakpoint occurs if any accessed byte falls within the range specified by

LEN_n. For instruction breakpoints, LEN_n must specify a single-byte range. The LEN_n encodings used to specify the address range are described on page 332 of “Debug-Control Register (DR7).”

Table 13-1 shows several examples of data accesses, and whether or not they cause a #DB exception to occur based on the breakpoint address in DR_n and the breakpoint-address range specified by LEN_n. In this table, R/W_n always specifies read/write access.

Table 13-1. Breakpoint-Setting Examples

Data-Access Address (hexadecimal)	Access Size (bytes)	Byte-Addresses in Data-Access (hexadecimal)	Breakpoint-Address Range (hexadecimal)	Result
DR _n =F000, LEN _n =00 (1 Byte)				
EFFB	8	EFFB, EFFC, EFFD, EFFE, EFFF, F000, F001	F000	#DB
EFFE	2	EFFE, EFFF		—
	4	EFFE, EFFF, F000, F001		#DB
F000	1	F000		—
F001	2	F001, F002		—
F005	4	F005, F006, F007, F008		—
DR _n =F004, LEN _n =11 (4 Bytes)				
EFFB	8	EFFB, EFFC, EFFD, EFFE, EFFF, F000, F001	F004–F007	—
EFFE	2	EFFE, EFFF		
	4	EFFE, EFFF, F000, F001		
F000	1	F000		
F001	2	F001, F002		
F005	4	F005, F006, F007, F008		#DB
DR _n =F005, LEN _n =10 (8 Bytes)				
EFFB	8	EFFB, EFFC, EFFD, EFFE, EFFF, F000, F001	F000–F007	#DB
EFFE	2	EFFE, EFFF		—
	4	EFFE, EFFF, F000, F001		#DB
F000	1	F000		
F001	2	F001, F002		
F005	4	F005, F006, F007, F008		
Note: “—” indicates no #DB occurs.				

13.2.2 Using Breakpoints

A debug exception (#DB) occurs when an enabled-breakpoint condition is encountered during program execution. The debug-handler must check the debug-status register (DR6), the conditions enabled by the debug-control register (DR7), and the debug-control MSR (DebugCtlMSR), to determine the #DB cause. The #DB exception corresponds to interrupt-vector 1. See “#DB—Debug Exception (Vector 1)” on page 211.

Instruction breakpoints and general-detect conditions cause the #DB exception to occur *before* the instruction is executed, while all other breakpoint and single-stepping conditions cause the #DB exception to occur *after* the instruction is executed. Table 13-2 summarizes where the #DB exception occurs based on the breakpoint condition.

Table 13-2. Breakpoint Location by Condition

Breakpoint Condition	Breakpoint Location
Instruction	Before Instruction is Executed
General Detect	
Data Write Only	After Instruction is Executed ¹
Data Read or Data Write	
I/O Read or I/O Write	
Single Step ¹	After Instruction is Executed
Task Switch	
Note:	
1. Repeated operations (REP prefix) can breakpoint between iterations.	

Instruction breakpoints and general-detect conditions have a lower interrupt-priority than the other breakpoint and single-stepping conditions (see “Priorities” on page 226). Data-breakpoint conditions on the *previous* instruction occur before an instruction-breakpoint condition on the *next* instruction. However, if instruction and data breakpoints can occur as a result of executing a *single* instruction, the instruction breakpoint occurs first (before the instruction is executed), followed by the data breakpoint (after the instruction is executed).

Instruction Breakpoints. Instruction breakpoints are set by loading a breakpoint-address register (DR n) with the desired instruction virtual-address, and then setting the corresponding DR7 fields as follows:

- L n or G n is set to 1 to enable the breakpoint for either the local task or all tasks, respectively.
- R/W n is set to 00b to specify that the contents of DR n are to be compared only with the virtual address of the next instruction to be executed.
- LEN n must be set to 00b.

When a #DB exception occurs due to an instruction breakpoint-address in DR n , the corresponding B n field in DR6 is set to 1 to indicate that a breakpoint condition occurred. The breakpoint occurs before the instruction is executed, and the breakpoint-instruction address is pushed onto the debug-handler

stack. If multiple instruction breakpoints are set, the debug handler can use the B_n field to identify which register caused the breakpoint.

Returning from the debug handler causes the breakpoint instruction to be executed. Before returning from the debug handler, the $rFLAGS.RF$ bit should be set to 1 to prevent a reoccurrence of the #DB exception due to the instruction-breakpoint condition. The processor ignores instruction-breakpoint conditions when $rFLAGS.RF=1$, until after the next instruction (in this case, the breakpoint instruction) is executed. After the next instruction is executed, the processor clears $rFLAGS.RF$ to 0.

Data Breakpoints. Data breakpoints are set by loading a breakpoint-address register (DR_n) with the desired data virtual-address, and then setting the corresponding DR7 fields as follows:

- Ln or Gn is set to 1 to enable the breakpoint for either the local task or all tasks, respectively.
- R/W_n is set to 01b to specify that the data virtual-address is compared with the contents of DR_n only during a memory-write. Setting this field to 11b specifies that the comparison takes place during both memory reads and memory writes.
- LEN_n is set to 00b, 01b, 11b, or 10b to specify an address-match range of one, two, four, or eight bytes, respectively. Long mode must be active to set LEN_n to 10b.

When a #DB exception occurs due to a data breakpoint address in DR_n , the corresponding B_n field in DR6 is set to 1 to indicate that a breakpoint condition occurred. The breakpoint occurs after the data-access instruction is executed, which means that the original data is overwritten by the data-access instruction. If the debug handler needs to report the previous data value, it must save that value before setting the breakpoint.

Because the breakpoint occurs after the data-access instruction is executed, the address of the instruction following the data-access instruction is pushed onto the debug-handler stack. Repeated string instructions, however, can trigger a breakpoint before all iterations of the repeat loop have completed. When this happens, the address of the string instruction is pushed onto the stack during a #DB exception if the repeat loop is not complete. A subsequent IRET from the #DB handler returns to the string instruction, causing the remaining iterations to be executed. Most implementations cannot report breakpoints exactly for repeated string instructions, but instead report the breakpoint on an iteration later than the iteration where the breakpoint occurred.

I/O Breakpoints. I/O breakpoints are set by loading a breakpoint-address register (DR_n) with the I/O-port address to be trapped, and then setting the corresponding DR7 fields as follows:

- Ln or Gn is set to 1 to enable the breakpoint for either the local task or all tasks, respectively.
- R/W_n is set to 10b to specify that the I/O-port address is compared with the contents of DR_n only during execution of an I/O instruction. This encoding of R/W_n is valid only when debug extensions are enabled ($CR4.DE=1$).
- LEN_n is set to 00b, 01b, or 11b to specify the breakpoint occurs on a byte, word, or doubleword I/O operation, respectively.

The I/O-port address specified by the I/O instruction is zero extended by the processor to 64 bits before comparing it with the DR_n registers.

When a #DB exception occurs due to an I/O breakpoint in DR n , the corresponding B n field in DR6 is set to 1 to indicate that a breakpoint condition occurred. The breakpoint occurs after the instruction is executed, which means that the original data is overwritten by the breakpoint instruction. If the debug handler needs to report the previous data value, it must save that value before setting the breakpoint.

Because the breakpoint occurs after the instruction is executed, the address of the instruction following the I/O instruction is pushed onto the debug-handler stack, in most cases. In the case of INS and OUTS instructions that use the repeat prefix, however, the breakpoint occurs after the first iteration of the repeat loop. When this happens, the I/O-instruction address can be pushed onto the stack during a #DB exception if the repeat loop is not complete. A subsequent return from the debug handler causes the next I/O iteration to be executed. If the breakpoint condition is still set, the #DB exception reoccurs after that iteration is complete.

Task-Switch Breakpoints. Breakpoints can be set in a task TSS to raise a #DB exception after a task switch. Software enables a task breakpoint by setting the T bit in the TSS to 1. When a task switch occurs into a task with the T bit set, the processor completes loading the new task state. Before the first instruction is executed, the #DB exception occurs, and the processor sets DR6.BT to 1, indicating that the #DB exception occurred as a result of task breakpoint.

The processor does not clear the T bit in the TSS to 0 when the #DB exception occurs. Software must explicitly clear this bit to disable the task breakpoint. Software should never set the T-bit in the debug-handler TSS if a separate task is used for #DB exception handling, otherwise the processor loops on the debug handler.

General-Detect Condition. General-detect is a special debug-exception condition that occurs when software running at any privilege level attempts to access any of the DR n registers while DR7.GD is set to 1. When a #DB exception occurs due to the general-detect condition, the processor clears DR7.GD to 0 and sets DR6.BD to 1. Clearing DR7.GD to 0 allows the debug handler to access the DR n registers without causing infinite #DB exceptions.

A debugger enables general detection to prevent other software from accessing and interfering with the debug registers while they are in use by the debugger. The exception is taken before executing the MOV DR n instruction so that the DR n contents are not altered.

13.2.3 Single Stepping

Single-step breakpoints are enabled by setting the rFLAGS.TF bit to 1. When single stepping is enabled, a #DB exception occurs after every instruction is executed until it is disabled by clearing rFLAGS.TF to 0. However, the instruction that sets the TF bit, and the instruction that follows it, is *not* single stepped.

When a #DB exception occurs due to single stepping, the processor clears rFLAGS.TF to 0 before entering the debug handler, so that the debug handler itself is not single stepped. The processor also sets DR6.BS to 1, which indicates that the #DB exception occurred as a result of single stepping. The rFLAGS image pushed onto the debug-handler stack has the TF bit set, and single stepping resumes when a subsequent IRET pops the stack image into the rFLAGS register.

Single-step breakpoints have a higher priority than external interrupts. If an external interrupt occurs during single stepping, control is transferred to the #DB handler first, causing the rFLAGS.TF bit to be cleared to 0. Next, before the first instruction in the debug handler is executed, the processor transfers control to the pending-interrupt handler. This allows external interrupts to be handled outside of single-step mode.

The $INTn$, INT3, and INTO instructions clear the rFLAGS.TF bit to 0 when they are executed. If a debugger is used to single-step software that contains these instructions, it must emulate them instead of executing them.

The single-step mechanism can also be set to single step only control transfers, rather than single step every instruction. See “Single Stepping Control Transfers” on page 341 for additional information.

13.2.4 Breakpoint Instruction (INT3)

The INT3 instruction, or the $INTn$ instruction with an operand of 3, can be used to set breakpoints that transfer control to the breakpoint-exception (#BP) handler rather than the debug-exception handler. When a debugger uses the breakpoint instructions to set breakpoints, it does so by replacing the first bytes of an instruction with the breakpoint instruction. The debugger replaces the breakpoint instructions with the original-instruction bytes to clear the breakpoint.

INT3 is a single-byte instruction while $INTn$ with an operand of 3 is a two-byte instruction. The instructions have slightly different effects on the breakpoint exception-handler stack. See “#BP—Breakpoint Exception (Vector 3)” on page 212 for additional information on this exception.

13.2.5 Control-Transfer Breakpoint Features

A control transfers is accomplished by using one of following instructions:

- JMP, CALL, RET
- Jcc , $JrCXZ$, $LOOPcc$
- JMPF, CALLF, RETF
- $INTn$, INT 3, INTO, ICEBP
- Exceptions, IRET
- SYSCALL, SYSRET, SYSENTER, SYSEXIT
- INTR, NMI, SMI, RSM

Recording Control Transfers. Software enables control-transfer recording by setting DebugCtlMSR.LBR to 1. When this bit is set, the processor updates the recording MSR's automatically when control transfers occur:

- *LastBranchFromIP* and *LastBranchToIP* Registers—On branch instructions, the LastBranchFromIP register is loaded with the segment offset of the branch instruction, and the LastBranchToIP register is loaded with the first instruction to be executed after the branch. On interrupts and exceptions, the LastBranchFromIP register is loaded with the segment offset of the

interrupted instruction, and the LastBranchToIP register is loaded with the offset of the interrupt or exception handler.

- *LastExceptionFromIP and LastExceptionToIP Registers*—The processor loads these from the LastBranchFromIP register and the LastBranchToIP register, respectively, when most interrupts and exceptions are taken. These two registers are not updated, however, when #DB or #MC exceptions are taken, or the ICEBP instruction is executed.

The processor automatically disables control-transfer recording when a debug exception (#DB) occurs by clearing DebugCtlMSR.LBR to 0. The contents of the control-transfer recording MSR are not altered by the processor when the #DB occurs. Before exiting the debug-exception handler, software can set DebugCtlMSR.LBR to 1 to re-enable the recording mechanism.

Debuggers can trace a control transfer backward from a bug to its source using the recording MSRs and the breakpoint-address registers. The debug handler does this by updating the breakpoint registers from the recording MSRs after a #DB exception occurs, and restarting the program. The program takes a #DB exception on the previous control transfer, and this process can be repeated. The debug handler cannot simply copy the contents of the recording MSR into the breakpoint-address register. The recording MSRs hold segment offsets, while the debug registers hold virtual (linear) addresses. The debug handler must calculate the virtual address by reading the code-segment selector (CS) from the interrupt-handler stack, then reading the segment-base address from the CS descriptor, and adding that base address to the offset in the recording MSR. The calculated virtual-address can then be used as a breakpoint address.

Single Stepping Control Transfers. Software can enable control-transfer single stepping by setting DebugCtlMSR.BTF to 1 and rFLAGS.TF to 1. The processor automatically disables control-transfer single stepping when a debug exception (#DB) occurs by clearing DebugCtlMSR.BTF to 0. rFLAGS.TF is also cleared when a #DB exception occurs. Before exiting the debug-exception handler, software must set both DebugCtlMSR.BTF and rFLAGS.TF to 1 to restart single stepping.

When enabled, this single-step mechanism causes a #DB exception to occur on every branch instruction, interrupt, or exception. Debuggers can use this capability to perform a “coarse” single step across blocks of code (bound by control transfers), and then, as the problem search is narrowed, switch into a “fine” single-step mode on every instruction (DebugCtlMSR.BTF=0, rFLAGS.TF=1).

Debuggers can use both the single-step mechanism and recording mechanism to support full backward and forward tracing of control transfers.

13.3 Performance Optimization

The AMD64 architecture supports the performance-monitoring features introduced in earlier processor implementations. These features allow the selection of events to be monitored, and include a set of corresponding counter registers that track the frequency of monitored events. Software tools can use these features to identify performance bottlenecks, such as sections of code that have high cache-miss rates or frequently mis-predicted branches. This information can then be used as a guide for

improving or eliminating performance problems through software optimizations or hardware-design improvements.

The performance-monitoring features include:

- A set of performance-counter registers that count the frequency or duration of specific processor events.
- A set of performance-event-select registers used to specify the events that are tracked by the performance-counter registers.
- A time-stamp counter that can be used to count processor-clock cycles over time.
- A set of instruction-based sampling registers to profile instruction fetch performance.
- A set of instruction-based sampling registers to profile instruction execution performance.

Implementations are not required to support the performance counters and the event-select registers, the time-stamp counter, nor the instruction-based sampling registers for instruction fetch or instruction execution sampling. The presence of these features can be determined by executing the CPUID instruction, and checking the returned feature bits to determine their availability. See “Processor Feature Identification” on page 61 for more information on using the CPUID instruction.

The registers used in support of performance monitoring are model-specific registers (MSRs). See “Performance-Monitoring MSRs” on page 468 for a listing of the performance-monitoring MSR numbers and their reset values.

Each feature, and its use, is described in the following sections.

13.3.1 Performance Counters

Performance counters are used to count specific processor events, such as data-cache misses, or the duration of events, such as the number of clocks it takes to return data from memory after a cache miss. During event counting, the processor increments the counter when it detects an occurrence of the event. During duration measurement, the processor counts the number of processor clocks it takes to complete an event. Each performance counter can be used to count one event, or measure the duration of one event, at a time.

Implementations of the AMD64 architecture can support any number of performance counters, *PerfCtrn*. The length, in bits, of the performance counters is also implementation dependent, but the maximum length supported is 64 bits. Figure 13-6 shows the format of the *PerfCtrn* register.

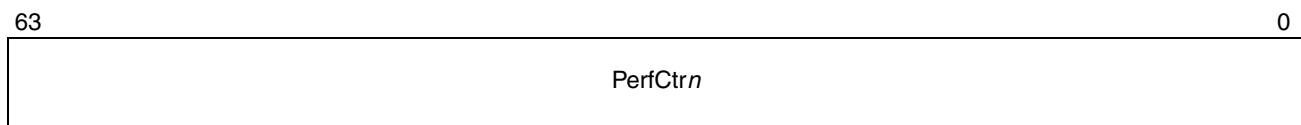

Figure 13-6. Performance Counter (*PerfCtrn*)

The PerfCtrn registers are model-specific registers that can be read using a special *read performance-monitoring counter* instruction, RDPMC. The RDPMC instruction loads the contents of the PerfCtrn register specified by the ECX register, into the EDX register and the EAX register. The high 32 bits are loaded into EDX, and the low 32 bits are loaded into EAX. RDPMC can be executed only at CPL=0, unless system software enables use of the instruction at all privilege levels. RDPMC can be enabled for use at all privilege levels by setting CR4.PCE (the *performance-monitor counter-enable* bit) to 1. When CR4.PCE = 0 and CPL > 0, attempts to execute RDPMC result in a general-protection exception (#GP).

The performance counters can also be read and written by system software running at CPL=0 using the RDMSR and WRMSR instructions, respectively. Writing the performance counters can be useful if software wants to count a specific number of events, and then trigger an interrupt when that count is reached. An interrupt can be triggered when a performance counter overflows (see “Counter Overflow” on page 346 for additional information). Software should use the WRMSR instruction to load the count as a two’s-complement negative number into the performance counter. This causes the counter to overflow after counting the appropriate number of times.

The performance counters are not guaranteed to produce identical measurements each time they are used to measure a particular instruction sequence, and they should not be used to take measurements of very small instruction sequences. The RDPMC instruction is not serializing, and it can be executed out-of-order with respect to other instructions around it. Even when bound by serializing instructions, the system environment at the time the instruction is executed can cause events to be counted before the counter value is loaded into EDX:EAX.

13.3.2 Performance Event-Select Registers

Performance event-select registers (PerfEvtSel n) are 64-bit registers used to specify the events counted by the performance counters, and to control other aspects of their operation. Each performance counter supported by the implementation has a corresponding event-select register that controls its operation. Figure 13-7 on page 344 shows the format of the PerfEvtSel n register.

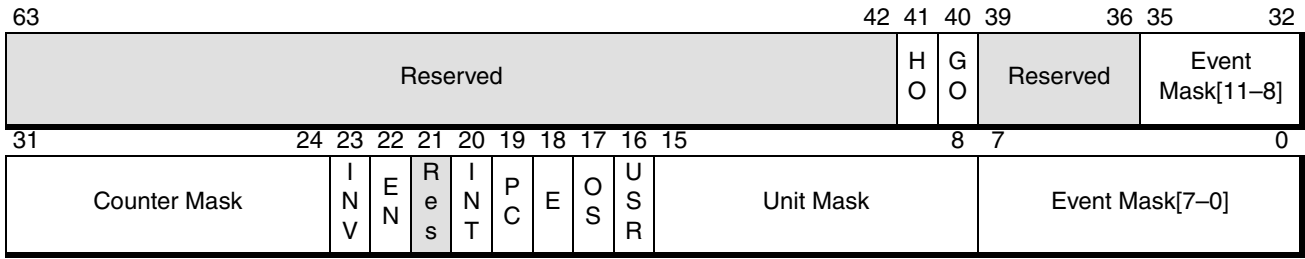

Bits	Mnemonic	Description	R/W
63-42		Reserved	
41	HO	Host Only	R/W
40	GO	Guest Only	R/W
39-36		Reserved	
35-32		Event Mask[11-8]	R/W
31-24		Counter Mask	R/W
23	INV	Invert Mask	R/W
22	EN	Counter Enable	R/W
21		Reserved	
20	INT	Interrupt Enable	R/W
19	PC	Pin Control	R/W
18	E	Edge Detect	R/W
17	OS	Operating-System Mode	R/W
16	USR	User Mode	R/W
15-8		Unit Mask	R/W
7-0		Event Mask[7-0]	R/W

Figure 13-7. Performance Event-Select Register (PerfEvtSeln)

The fields within the PerfEvtSeln register are:

- Event Mask[11:8]—Bits 35-32, read/write. This field extends the Event Mask (bits 7-0) from 8 bits to 12 bits. See Event Mask
- Guest Only (GO)—Bit 41, read/write. Software sets this bit to 1 to enable counting in the corresponding PerfCtrn when the processor is in guest mode. Clearing this bit to 0 disables counting in the corresponding PerfCtrn when the processor is in guest mode. If GO = HO = 1, or if GO = HO = 0, counting in the corresponding PerfCtrn is enabled when the processor is in either guest mode or host mode.
- Host Only (HO)—Bit 40, read/write. Software sets this bit to 1 to enable counting in the corresponding PerfCtrn when the processor is in host mode. Clearing this bit to 0 disables counting in the corresponding PerfCtrn when the processor is in host mode. If GO = HO = 1, or if GO = HO = 0, counting in the corresponding PerfCtrn is enabled when the processor is in either guest mode or host mode.

- *Event Mask*—Bits 7–0, read/write. This field specifies both the event or event duration to be counted by the corresponding PerfCtrn register. The events that can be counted are implementation dependent. For more information, refer to the BIOS writer’s guide for the implementation.
- *Unit Mask*—Bits 15–8, read/write. This field can be used to specify a particular processor unit to be monitored, if the event counted can be produced by multiple units within the processor. Implementations can also use this field to further specify or qualify a monitored event.
- *Operating-System Mode (OS) and User Mode (USR)*—Bits 17–16 (respectively), read/write. Software uses these bits to control the privilege level at which event counting is performed according to Table 13-3.

Table 13-3. Operating-System Mode and User Mode Bits

OS Mode (Bit 17)	USR Mode (Bit 16)	Event Counting
0	0	No counting.
0	1	Only at CPL > 0.
1	0	Only at CPL = 0.
1	1	At all privilege levels.

- *Edge Detect (E)*—Bit 18, read/write. Software sets this bit to 1 to count the number of edge transitions from the negated to asserted state. This feature is useful when coupled with event-duration monitoring, as it can be used to calculate the average time spent in an event. Clearing this bit to 0 disables edge detection.
- *Pin Control (PC)*—Bit 19, read/write. Software sets this bit to 1 to cause the external PMi pins on the processor to toggle when the counter overflows. When this bit is cleared to 0, the processor toggles the PMi pins each time it increments the performance counter.
- *Interrupt Enable (INT)*—Bit 20, read/write. Software sets this bit to 1 to enable an interrupt to occur when the performance counter overflows (see “Counter Overflow” on page 346 for additional information). Clearing this bit to 0 disables the triggering of the interrupt.
- *Counter Enable (EN)*—Bit 22, read/write. Software sets this bit to 1 to enable the PerfEvtSeln register, and counting in the corresponding PerfCtrn register. Clearing this bit to 0 disables the register pair.
- *Invert Mask (INV)*—Bit 23, read/write. Software sets this bit to 1 to invert the comparison result performed on the counter-mask field, so that a less-than or equal-to comparison can be performed. Clearing this bit to 0 leaves the comparison result alone, so that a greater-than or equal-to comparison is reported.
- *Counter Mask*—Bits 31–24, read/write. This field is used to set a threshold for counting multiple events that can occur in a single clock. If the number of events occurring in the single clock is greater than or equal to this field, the corresponding PerfCtrn register is incremented. PerfCtrn is not incremented if the number of events is less than the count mask.

The INV bit, when set, causes the PerfCtrn register to be incremented when the comparison is less than or equal to the count mask. In this case, PerfCtrn is not incremented if the number of events is greater than the count mask.

The performance event-select registers can be read and written only by system software running at CPL = 0 using the RDMSR and WRMSR instructions, respectively. Any attempt to read or write these registers at CPL > 0 causes a general-protection exception to occur.

13.3.3 Using Performance Counters

Starting and Stopping. Performance counting in a PerfCtrn register is initiated by setting the corresponding PerfEvtSeln.EN bit to 1. Counting is stopped by clearing PerfEvtSeln.EN to 0. Software must initialize the remaining PerfEvtSeln fields with the appropriate setup information before or at the same time EN is set. Counting begins when the WRMSR instruction that sets PerfEvtSeln.EN to 1 completes execution. Counting stops when the WRMSR instruction that clears PerfEvtSeln.EN to 0 completes execution.

Counter Overflow. Some processor implementations support an interrupt-on-overflow capability that allows an interrupt to occur when one of the PerfCtrn registers overflows. The source and type of interrupt is implementation dependent. Some implementations cause a debug interrupt to occur, while others make use of the local APIC to specify the interrupt vector and trigger the interrupt when an overflow occurs. Software controls the triggering of an interrupt by setting or clearing the PerfEvtSeln.INT bit.

If system software makes use of the interrupt-on-overflow capability, an interrupt handler must be provided that can record information relevant to the counter overflow. Before returning from the interrupt handler, the performance counter can be re-initialized to its previous state so that another interrupt occurs when the appropriate number of events are counted.

13.3.4 Time-Stamp Counter

The time-stamp counter (TSC) is used to count processor-clock cycles. The TSC is cleared to 0 after a processor reset. After a reset, the TSC is incremented by one for every processor clock cycle. Each time the TSC is read, it returns a monotonically-larger value than the previous value read from the TSC. When the TSC contains all ones, it wraps to zero. The TSC in a 1-GHz processor counts for almost 600 years before it wraps. Figure 13-8 shows the format of the 64-bit time-stamp counter (TSC).

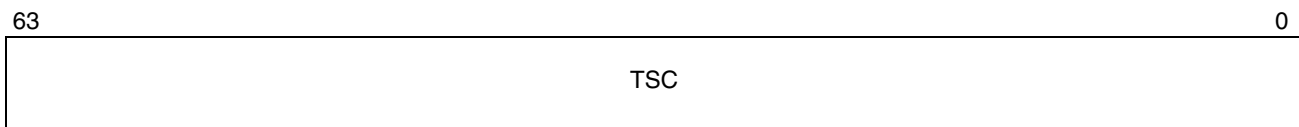

Figure 13-8. Time-Stamp Counter (TSC)

The TSC is a model-specific register that can also be read using one of the special *read time-stamp counter* instructions, RDTSC(Read Time-Stamp Counter (TSC)) or RDTSCP (Read Time-Stamp

Counter and Processor ID). The RDTSC and RDTSCP instructions load the contents of the TSC into the EDX register and the EAX register. The high 32 bits are loaded into EDX, and the low 32 bits are loaded into EAX. The RDTSC and RDTSCP instructions can be executed at any privilege level and from any processor mode. However, system software can disable the RDTSC or RDTSCP instructions for programs that run at CPL > 0 by setting CR4.TSD (the *time-stamp disable* bit) to 1. When CR4.TSD = 1 and CPL > 0, attempts to execute RDSTC or RDSTCP result in a general-protection exception (#GP).

Some implementations allow the TSC register to be read and written using the RDMSR and WRMSR instructions, respectively. Support of this capability, however, is not required by the architecture, and software should avoid using these instructions to access the TSC. The programmer should use the CPUID instruction to determine whether these features are supported. If EDX bit 4 (as returned by CPUID function 1) is set, then the processor supports TSC, the RDTSC instruction and CR4.TSD. If EDX bit 27 returned by CPUID function 8000_0001h is set, then the processor supports the RDTSCP instruction.

The TSC register can be used by performance-analysis applications, along with the performance-monitoring registers, to help determine the relative frequency of an event or its duration. Software can also use the TSC to time software routines to help identify candidates for optimization. In general, the TSC should not be used to take very short time measurements, because the resulting measurement is not guaranteed to be identical each time it is made. The RDTSC instruction (unlike the RDTSCP instruction) is not serializing, and can be executed out-of-order with respect to other instructions around it. Even when bound by serializing instructions, the system environment at the time the instruction is executed can cause additional cycles to be counted before the TSC value is loaded into EDX:EAX.

The behavior of the RDTSC (Read Time-Stamp Counter (TSC)) and RDTSCP (Read Time-Stamp Counter and Processor ID) is implementation dependent. When using these instructions, programmers must be aware that the TSC counts at a constant rate, but may be affected by power management events (such as frequency changes), depending on the processor implementation. Consult the BIOS and kernel developer's guide for your AMD processor implementation for information concerning the effect of power management on the TSC.

14 Processor Initialization and Long Mode Activation

This chapter describes the hardware actions taken following a processor reset and the steps that must be taken to initialize processor resources and activate long mode. In some cases the actions required are implementation-specific with references made to the appropriate implementation-specific documentation.

14.1 Reset and Initialization

System logic initializes the processor in one of two ways. One method is to assert an external reset signal (typically designated RESET#). The other method, referred to here as INIT, is performed using implementation-dependent external signalling. Both initialization techniques place the processor in real mode and initialize processor resources to a known, consistent state from which software can begin execution. The differences between the two methods are:

- *RESET#*—This method provides an optional *built-in self test* (BIST) that can be performed as part of the RESET# process.
- *INIT*—This method does not modify the following state:
 - Memory hierarchy, including internal and external caches.
 - 128-bit media, 64-bit media, or x87 resources.
 - Memory-type range registers (MTRRs).
 - Machine-check registers.

Some, but not all, model-specific registers (MSRs) are modified by an INIT.

BIST cannot be performed as part of the INIT process.

The processor always performs RESET# after it is powered up, but RESET# can be performed at any time. An INIT can be performed at any time after the processor is powered up.

14.1.1 Built-In Self Test (BIST)

An optional built-in self-test can be performed after RESET# is asserted. The mechanism for triggering the BIST is implementation-specific, and can be found in the hardware documentation for the implementation. The number of processor cycles BIST can consume before completing is also implementation-specific but typically consumes several million cycles.

BIST can be used by system implementations to assist in verifying system integrity, thereby improving system reliability, availability, and serviceability. The internal BIST hardware generally tests all internal array structures for errors. These structures can include (but are not limited to):

- All internal caches, including the tag arrays as well as the data arrays.
- All TLBs.

- Internal ROMs, such as the microcode ROM and floating-point constant ROM.
- Branch-prediction structures.

EAX is loaded with zero if BIST completes without detecting errors. If any hardware faults are detected during BIST, a non-zero value is loaded into EAX.

14.1.2 Clock Multiplier Selection

The internal processor clock runs at some multiple of the system clock. The processor-to-system clock multiple does not have to be fixed by a processor implementation but instead can be programmable through hardware or software, or some combination of the two. For information on selecting the processor-clock multiplier, refer to the BIOS writer’s guide for the implementation.

14.1.3 Processor Initialization State

Table 14-1 shows the initial processor state following either RESET# or INIT. Except as indicated, processor resources generally are set to the same value after either RESET# or INIT.

Table 14-1. Initial Processor State

Processor Resource	Reset (RESET#) Value	Initialization (INIT) Value
CR0	0000_0000_6000_0010h	CD and NW are unchanged Bit 4 (reserved) = 1 All others = 0
CR2, CR3, CR4	0	
CR8	0	Not modified
RFLAGS	0000_0000_0000_0002h	
EFER	0	
RIP	0000_0000_0000_FFF0h	
CS	Selector = F000h Base = 0000_0000_FFFF_0000h Limit = FFFFh Attributes = See Table 14-2 on page 352	
DS, ES, FS, GS, SS	Selector = 0000h Base = 0 Limit = FFFFh Attributes = See Table 14-2 on page 352	
GDTR, IDTR	Base = 0 Limit = FFFFh	
LDTR, TR	Selector = 0000h Base = 0 Limit = FFFFh Attributes = See Table 14-2 on page 352	

Table 14-1. Initial Processor State (continued)

Processor Resource	Reset (RESET#) Value	Initialization (INIT) Value
RAX	0 (non-zero if BIST is run and fails)	0
RDX	Family/Model/Stepping, including extended family and extended model—see “Processor Implementation Information” on page 353	
RBX, RCX, RBP, RSP, RDI, RSI, R8, R9, R10, R11, R12, R13, R14, R15	0	
x87 Floating-Point State	FPR0–FPR7 = 0 Control Word = 0040h Status Word = 0000h Tag Word = 5555h Instruction CS = 0000h Instruction Offset = 0 x87 Instruction Opcode = 0 Data-Operand DS = 0000h Data-Operand Offset = 0	Not modified
64-Bit Media State	MMX0–MMX7 = 0	Not modified
128-Bit Media State	XMM0–XMM15 = 0 MXCSR = 1F80h	Not modified
Memory-Type Range Registers	See “Memory-Typing MSRs” on page 464	Not modified
Machine-Check Registers	See “Machine-Check MSRs” on page 466	Not modified
DR0, DR1, DR2, DR3	0	
DR6	0000_0000_FFFF_0FF0h	
DR7	0000_0000_0000_0400h	
Time-Stamp Counter	0	Not modified
Performance-Monitor Resources	See “Performance-Monitoring MSRs” on page 468	Not modified
Other Model-Specific Registers	See “MSR Cross-Reference” on page 459	Not modified
Instruction and Data Caches	Invalidated	Not modified
Instruction and Data TLBs		
APIC	Enabled	Not modified
SMRAM Base Address (SMBASE)	0003_0000h	Not modified

Table 14-2 on page 352 shows the initial state of the segment-register attributes (located in the hidden portion of the segment registers) following either RESET# or INIT.

Table 14-2. Initial State of Segment-Register Attributes

Attribute		Value (Binary)	Description
G		0	Byte Granularity
D/B		0	16-Bit Segment
L (CS Only)		0	Legacy-Mode Segment
P		1	Segment is Present
DPL		00	Privilege-Level 0
S and Type	Code Segment	S = 1 Type = 1010	Executable/Readable Code Segment
	Data Segment	S = 1 Type = 0010	Read/Write Data Segment
	LDTR	S = 0 Type = 0010	LDT
	TR	S = 0 Type = 0011	Busy 16-Bit TSS

14.1.4 Multiple Processor Initialization

Following reset in multiprocessor configurations, the processors use a multiple-processor initialization protocol to negotiate which processor becomes the *bootstrap* processor. This bootstrap processor then executes the system initialization code while the remaining processors wait for software initialization to complete. For further information, see the documentation for particular implementations of the architecture.

14.1.5 Fetching the First Instruction

After a RESET# or INIT, the processor is operating in 16-bit real mode. Normally within real mode, the code-segment base-address is formed by shifting the CS-selector value left four bits. The base address is then added to the value in EIP to form the physical address into memory. As a result, the processor can only address the first 1 Mbyte of memory when in real mode.

However, immediately following RESET# or INIT, the CS-selector register is loaded with F000h, but the CS base-address is *not* formed by left-shifting the selector. Instead, the CS base-address is initialized to FFFF_0000h. EIP is initialized to FFF0h. Therefore, the first instruction fetched from memory is located at physical-address FFFF_FFF0h (FFFF_0000h + 0000_FFF0h).

The CS base-address remains at this initial value until the CS-selector register is loaded by software. This can occur as a result of executing a far jump instruction or call instruction, for example. When CS is loaded by software, the new base-address value is established as defined for real mode (by left shifting the selector value four bits).

14.2 Hardware Configuration

14.2.1 Processor Implementation Information

Software can read processor-identification information from the EDX register immediately following RESET# or INIT. This information can be used to initialize software to perform processor-specific functions. The information stored in EDX is defined as follows:

- *Stepping ID (bits 3–0)*—This field identifies the processor-revision level.
- *Extended Model (bits 19–16) and Model (bits 7–4)*—These fields combine to differentiate processor models within a instruction family. For example, two processors may share the same microarchitecture but differ in their feature set. Such processors are considered different models within the same instruction family. This is a split field, comprising an extended-model portion in bits 19–16 with a legacy portion in bits 7–4
- *Extended Family (bits 27–20) and Family (bits 11–8)*—These fields combine to differentiate processors by their microarchitecture.

The CPUID instruction can be used to obtain the same information. This is done by executing CPUID with either function 1 or function 8000_0001h. Additional information about the processor and the features supported can be gathered using CPUID with other feature codes. See “Processor Feature Identification” on page 61 for additional information.

14.2.2 Enabling Internal Caches

Following a RESET# (but not an INIT), all instruction and data caches are disabled, and their contents are invalidated (the MOESI state is set to the invalid state). Software can enable these caches by clearing the cache-disable bit (CR0.CD) to zero (RESET# sets this bit to 1). Software can further refine caching based on individual pages and memory regions. Refer to “Cache Control Mechanisms” on page 179 for more information on cache control.

Memory-Type Range Registers (MTRRs). Following a RESET# (but not an INIT), the MTRRdefType register is cleared to 0, which disables the MTRR mechanism. The variable-range and fixed-range MTRR registers are not initialized and are therefore in an undefined state. Before enabling the MTRR mechanism, the initialization software (usually BIOS) must load these registers with a known value to prevent unexpected results. Clearing these registers, for example, sets memory to the uncacheable (UC) type.

14.2.3 Initializing Media and x87 Processor State

Some resources used by x87 floating-point instructions and 128-bit media instructions must be initialized by software before being used. Initialization software can use the CPUID instruction to determine whether the processor supports these instructions, and then initialize their resources as appropriate.

x87 Floating-Point State Initialization. Table 14-3 on page 354 shows the differences between the initial x87 floating-point state following a RESET# and the state established by the FINIT/FNINIT

instruction. An INIT does not modify the x87 floating-point state. The initialization software can execute an FINIT or FNINIT instruction to prepare the x87 floating-point unit for use by application software. The FINIT and FNINIT instructions have no effect on the 64-bit media state.

Table 14-3. x87 Floating-Point State Initialization

x87 Floating-Point Resource	RESET#	FINIT/FNINIT Instructions
FPR0–FPR7	0	Not modified
Control Word	0040h • Round to nearest • Single precision • Unmask all exceptions	037Fh • Round to nearest • Extended precision • Mask all exceptions
Status Word	0000h	
Tag Word	5555h (FPR n contain zero)	FFFFh (FPR n are empty)
Instruction CS	0000h	
Instruction Offset	0	
x87 Instruction Opcode	0	
Data-Operand DS	0000h	
Data-Operand Offset	0	

Initialization software should also load the MP, EM, and NE bits in the CR0 register as appropriate for the operating system. The recommended settings for implementations of the AMD64 architecture are:

- *MP=1*—Setting MP to 1 causes a device-not-available exception (#NM) to occur when the FWAIT/WAIT instruction is executed and the task-switched bit (CR0.TS) is set to 1. This supports operating systems that perform lazy context-switching of x87 floating-point state.
- *EM=0*—Clearing EM to 0 allows the x87 floating-point unit to execute instructions rather than causing a #NM exception (CR0.EM=1). System software sets EM to 1 only when software emulation of x87 instructions is desired.
- *NE=1*—Setting NE to 1 causes x87 floating-point exceptions to be handled by the floating-point exception-pending exception (#MF) handler. Clearing this bit causes the processor to externally indicate the exception occurred, and an external device can then cause an external interrupt to occur in response.

Refer to “CR0 Register” on page 42 for additional information on these control bits.

64-Bit Media State Initialization. There are no special requirements placed on software to initialize the processor state used by 64-bit media instructions. This state is initialized completely by the processor following a RESET#. System software should leave CR0.EM cleared to 0 to allow execution of the 64-bit media instructions. If CR0.EM is set to 1, attempted execution of the 64-bit media instructions causes an invalid-opcode exception (#UD).

The 64-bit media state is not modified by an INIT.

128-Bit Media State Initialization. BIOS or system software must also prepare the processor to allow execution of 128-bit media instructions. The required preparations include:

- Leaving CR0.EM cleared to 0 to allow execution of the 128-bit media instructions. If CR0.EM is set to 1, attempted execution of the 128-bit media instructions causes an invalid-opcode exception (#UD).
- Enabling the 128-bit media instructions by setting CR4.OSFXSR to 1. Software cannot execute the 128-bit media instructions unless this bit is set. Setting this bit also indicates that system software uses the FXSAVE and FXRSTOR instructions to save and restore, respectively, the 128-bit media state. These instructions also save and restore the 64-bit media state and x87 floating-point state.
- Indicating that system software uses the SIMD floating-point exception (#XF) for handling 128-bit media floating-point exceptions. This is done by setting CR4.OSXMMEXCPT to 1.
- Setting (optionally) the MXCSR mask bits to mask or unmask 128-bit media floating-point exceptions as desired. Because this register can be read and written by application software, it is not absolutely necessary for system software to initialize it.

Refer to “CR4 Register” on page 47 for additional information on these CR4 control bits.

14.2.4 Model-Specific Initialization

Implementations of the AMD64 architecture can contain model-specific features and registers that are not initialized by the processor and therefore require system-software initialization. System software must use the CPUID instruction to determine which features are supported. Model-specific features are generally configured using model-specific registers (MSRs), which can be read and written using the RDMSR and WRMSR instructions, respectively.

Some of the model-specific features are pervasive across many processor implementations of the AMD64 architecture and are therefore described within this volume. These include:

- System-call extensions, which must be enabled in the EFER register before using the SYSCALL and SYSRET instructions. See “System-Call Extension (SCE) Bit” on page 55 for information on enabling these instructions.
- Memory-typing MSRs. See “Memory-Type Range Registers (MTRRs)” on page 353 for information on initializing and using these registers.
- The machine-check mechanism. See “Initializing the Machine-Check Mechanism” on page 267 for information on enabling and using this capability.
- Extensions to the debug mechanism. See “Software-Debug Resources” on page 327 for information on initializing and using these extensions.
- The performance-monitoring resources. See “Performance Optimization” on page 341 for information on initializing and using these resources.

Initialization of other model-specific features used by the page-translation mechanism and long mode are described throughout the remainder of this section.

Some model-specific features are not pervasive across processor implementations and are therefore not described in this volume. For more information on these features and their initialization requirements, refer to the BIOS writer's guide for the implementation.

14.3 Initializing Real Mode

A basic real-mode (real-address-mode) operating environment must be initialized so that system software can initialize the protected-mode operating environment. This real-mode environment must include:

- A real-mode IDT for vectoring interrupts and exceptions to the appropriate handlers while in real mode. The IDT base-address value in the IDTR initialized by the processor can be used, or system software can relocate the IDT by loading a new base-address into the IDTR.
- The real-mode interrupt and exception handlers. These must be loaded before enabling external interrupts.

Because the processor can always accept a non-maskable interrupt (NMI), it is possible an NMI can occur before initializing the IDT or the NMI handler. System hardware must provide a mechanism for disabling NMIs to allow time for the IDT and NMI handler to be properly initialized. Alternatively, the IDT and NMI handler can be stored in non-volatile memory that is referenced by the initial values loaded into the IDTR.

Maskable interrupts can be enabled by setting EFLAGS.IF after the real-mode IDT and interrupt handlers are initialized.

- A valid stack pointer (SS:SP) to be used by the interrupt mechanism should interrupts or exceptions occur. The values of SS:SP initialized by the processor can be used.
- One or more data-segment selectors for storing the protected-mode data structures that are created in real mode.

Once the real-mode environment is established, software can begin initializing the protected-mode environment.

14.4 Initializing Protected Mode

Protected mode must be entered before activating long mode. A minimal protected-mode environment must be established to allow long-mode initialization to take place. This environment must include the following:

- A protected-mode IDT for vectoring interrupts and exceptions to the appropriate handlers while in protected mode.
- The protected-mode interrupt and exception handlers referenced by the IDT. Gate descriptors for each handler must be loaded in the IDT.
- A GDT which contains:
 - A code descriptor for the code segment that is executed in protected mode.

- A read/write data segment that can be used as a protected-mode stack. This stack can be used by the interrupt mechanism if interrupts or exceptions occur.

Software can optionally load the GDT with one or more data segment descriptors, a TSS descriptor, and an LDT descriptor for use by long-mode initialization software.

After the protected-mode data structures are initialized, system software must load the IDTR and GDTR (and optionally, the LDTR and TR) with pointers to those data structures. Once these registers are initialized, protected mode can be enabled by setting CR0.PE to 1.

If legacy paging is used during the long-mode initialization process, the page-translation tables must be initialized before enabling paging. At a minimum, one page directory and one page table are required to support page translation. The CR3 register must be loaded with the starting physical address of the highest-level table supported in the page-translation hierarchy. After these structures are initialized and protected mode is enabled, paging can be enabled by setting CR0.PG to 1.

14.5 Initializing Long Mode

From protected mode, system software can initialize the data structures required by long mode and store them anywhere in the first 4 Gbytes of physical memory. These data structures can be relocated above 4 Gbytes once long mode is activated. The data structures required by long mode include the following:

- An IDT with 64-bit interrupt-gate descriptors. Long-mode interrupts are always taken in 64-bit mode, and the 64-bit gate descriptors are used to transfer control to interrupt handlers running in 64-bit mode. See “Long-Mode Interrupt Control Transfers” on page 241 for more information.
- The 64-bit mode interrupt and exception handlers to be used in 64-bit mode. Gate descriptors for each handler must be loaded in the 64-bit IDT.
- A GDT containing segment descriptors for software running in 64-bit mode and compatibility mode, including:
 - Any LDT descriptors required by the operating system or application software.
 - A TSS descriptor for the single 64-bit TSS required by long mode.
 - Code descriptors for the code segments that are executed in long mode. The code-segment descriptors are used to specify whether the processor is operating in 64-bit mode or compatibility mode. See “Code-Segment Descriptors” on page 86, “Long (L) Attribute Bit” on page 87, and “CS Register” on page 69 for more information.
 - Data-segment descriptors for software running in compatibility mode. The DS, ES, and SS segments are ignored in 64-bit mode. See “Data-Segment Descriptors” on page 87 for more information.
 - FS and GS data-segment descriptors for 64-bit mode, if required by the operating system. If these segments are used in 64-bit mode, system software can also initialize the full 64-bit base addresses using the WRMSR instruction. See “FS and GS Registers in 64-Bit Mode” on page 70 for more information.

The existing protected-mode GDT can be used to hold the long-mode descriptors described above.

- A single 64-bit TSS for holding the privilege-level 0, 1, and 2 stack pointers, the interrupt-stack-table pointers, and the I/O-redirection-bitmap base address (if required). This is the only TSS required, because hardware task-switching is not supported in long mode. See “64-Bit Task State Segment” on page 317 for more information.
- The 4-level page-translation tables required by long mode. Long mode also requires the use of physical-address extensions (PAE) to support physical-address sizes greater than 32 bits. See “Long-Mode Page Translation” on page 128 for more information.

If paging is enabled during the initialization process, it *must* be disabled before enabling long mode. After the long-mode data structures are initialized, and paging is disabled, software can enable and activate long mode.

14.6 Enabling and Activating Long Mode

Long mode is *enabled* by setting the long-mode enable control bit (EFER.LME) to 1. However, long mode is not *activated* until software also enables paging. When software enables paging while long mode is enabled, the processor activates long mode, which the processor indicates by setting the long-mode-active status bit (EFER.LMA) to 1. The processor behaves as a 32-bit x86 processor in all respects until long mode is activated, even if long mode is enabled. None of the new 64-bit data sizes, addressing, or system aspects available in long mode can be used until EFER.LMA=1.

Table 14-4 shows the control-bit settings for enabling and activating the various operating modes of the AMD64 architecture. The default address and data sizes are shown for each mode. For the methods of overriding these default address and data sizes, see “Instruction Prefixes” in Volume 3.

Table 14-4. Processor Operating Modes

Mode		Encoding			Default Address Size (bits) ²	Default Data Size (bits) ²
		EFER.LMA ¹	CS.L	CS.D		
Long Mode	64-Bit Mode	1	1	0	64	32
	Compatibility Mode		0	1	32	32
		0		16	16	
Legacy Mode		0	x	1	32	32
				0	16	16

Note:

1. EFER.LMA is set by the processor when software sets EFER.LME and CR0.PG according to the sequence described in “Activating Long Mode” on page 359.
2. See “Instruction Prefixes” in Volume 1 for overrides to default sizes.

Long mode uses two code-segment-descriptor bits, CS.L and CS.D, to control the operating submodes. If long mode is active, CS.L = 1, and CS.D = 0, the processor is running in 64-bit mode, as shown in Table 14-4 on page 358. With this encoding (CS.L=1, CS.D=0), default operand size is 32 bits and default address size is 64 bits. Using instruction prefixes, the default operand size can be overridden to 64 bits or 16 bits, and the default address size can be overridden to 32 bits.

The final encoding of CS.L and CS.D in long mode (CS.L=1, CS.D=1) is reserved for future use.

When long mode is active and CS.L is cleared to 0, the processor is in compatibility mode, as shown in Table 14-4 on page 358. In compatibility mode, CS.D controls default operand and address sizes exactly as it does in the legacy x86 architecture. Setting CS.D to 1 specifies default operand and address sizes as 32 bits. Clearing CS.D to 0 specifies default operand and address sizes as 16 bits.

14.6.1 Activating Long Mode

Switching the processor to long mode requires several steps. In general, the sequence involves disabling paging (CR0.PG=0), enabling physical-address extensions (CR4.PAE=1), loading CR3, enabling long mode (EFER.LME=1), and finally enabling paging (CR0.PG=1).

Specifically, software must follow this sequence to activate long mode:

1. If starting from page-enabled protected mode, disable paging by clearing CR0.PG to 0. This requires that the MOV CR0 instruction used to disable paging be located in an identity-mapped page (virtual address equals physical address).
2. In any order:
 - Enable physical-address extensions by setting CR4.PAE to 1. Long mode requires the use of physical-address extensions (PAE) in order to support physical-address sizes greater than 32 bits. Physical-address extensions must be enabled before enabling paging.
 - Load CR3 with the physical base-address of the level-4 page-map-table (PML4). See “Long-Mode Page Translation” on page 128 for details on creating the 4-level page translation tables required by long mode.
 - Enable long mode by setting EFER.LME to 1.
3. Enable paging by setting CR0.PG to 1. This causes the processor to set the EFER.LMA bit to 1. The instruction following the MOV CR0 that enables paging must be a branch, and both the MOV CR0 and the following branch instruction must be located in an identity-mapped page.

14.6.2 Consistency Checks

The processor performs long-mode consistency checks whenever software attempts to modify any of the control bits directly involved in activating long mode (EFER.LME, CR0.PG, and CR4.PAE). A general-protection exception (#GP) occurs when a consistency check fails. Long-mode consistency checks ensure that the processor does not enter an undefined mode or state that results in unpredictable behavior.

Long-mode consistency checks cause a general-protection exception (#GP) to occur if:

- An attempt is made to enable or disable long mode while paging is enabled.
- Long mode is enabled, and an attempt is made to enable paging before enabling physical-address extensions (PAE).
- Long mode is enabled, and an attempt is made to enable paging while CS.L=1.
- Long mode is active and an attempt is made to disable physical-address extensions (PAE).

Table 14-5 summarizes the long-mode consistency checks made during control-bit transitions.

Table 14-5. Long-Mode Consistency Checks

Control Bit	Transition	Check
EFER.LME	0 → 1	If (CR0.PG=1) then #GP(0)
	1 → 0	If (CR0.PG=1) then #GP(0)
CR0.PG	0 → 1	If ((EFER.LME=1) & (CR4.PAE=0) then #GP(0) If ((EFER.LME=1) & (CS.L=1)) then #GP(0)
CR4.PAE	1 → 0	If (EFER.LMA=1) then #GP(0)

14.6.3 Updating System Descriptor Table References

Immediately after activating long mode, the system-descriptor-table registers (GDTR, LDTR, IDTR, TR) continue to reference legacy descriptor tables. The tables referenced by these descriptors all reside in the lower 4 Gbytes of virtual-address space. After activating long mode, 64-bit operating-system software should use the LGDT, LLDT, LIDT, and LTR instructions to load the system descriptor-table registers with references to the 64-bit versions of the descriptor tables. See “Descriptor Tables” on page 71 for details on descriptor tables in long mode.

Long mode requires 64-bit interrupt-gate descriptors to be stored in the interrupt-descriptor table (IDT). Software must not allow exceptions or interrupts to occur between the time long mode is activated and the subsequent update of the interrupt-descriptor-table register (IDTR) that establishes a reference to the 64-bit IDT. This is because the IDTR continues to reference a 32-bit IDT immediately after long mode is activated. If an interrupt or exception occurred before updating the IDTR, a legacy 32-bit interrupt gate would be referenced and interpreted as a 64-bit interrupt gate, with unpredictable results.

External interrupts can be disabled using the CLI instruction. Non-maskable interrupts (NMI) and system-management interrupts (SMI) must be disabled using external hardware. See “Long-Mode Interrupt Control Transfers” on page 241 for more information on long mode interrupts.

14.6.4 Relocating Page-Translation Tables

The long-mode page-translation tables must be located in the first 4 Gbytes of physical-address space before activating long mode. This is necessary because the MOV CR3 instruction used to initialize the page-map level-4 base address must be executed in legacy mode before activating long mode. Because the MOV CR3 is executed in legacy mode, only the low 32 bits of the register are written, which limits the location of the page-map level-4 translation table to the low 4 Gbytes of memory. Software can

relocate the page tables anywhere in physical memory, and re-initialize the CR3 register, after long mode is activated.

14.7 Leaving Long Mode

To return from long mode to legacy protected mode with paging enabled, software must deactivate and disable long mode using the following sequence:

1. Switch to compatibility mode and place the processor at the highest privilege level (CPL=0).
2. Deactivate long mode by clearing CR0.PG to 0. This causes the processor to clear the LMA bit to 0. The MOV CR0 instruction used to disable paging must be located in an identity-mapped page. Once paging is disabled, the processor behaves as a standard 32-bit x86 processor.
3. Load CR3 with the physical base-address of the legacy page tables.
4. Disable long mode by clearing EFER.LME to 0.
5. Enable legacy page-translation by setting CR0.PG to 1. The instruction following the MOV CR0 that enables paging must be a branch, and both the MOV CR0 and the following branch instruction must be located in an identity-mapped page.

14.8 Long-Mode Initialization Example

Following is sample code that outlines the steps required to place the processor in long mode.

```
mydata segment para
;
;
; This generic data-segment holds pseudo-descriptors used
; by the LGDT and LIDT instructions.
;
;
; Establish a temporary 32-bit GDT and IDT.
;
pGDT32 label fword ; Used by LGDT.
          dw gdt32_limit ; GDT limit ...
          dd gdt32_base ; and 32-bit GDT base
pIDT32 label fword ; Used by LIDT.
          dw idt32_limit ; IDT limit ...
          dd idt32_base ; and 32-bit IDT base
;
; Establish a 64-bit GDT and IDT (64-bit linear base-
; address)
;
pGDT64 label tbyte ; Used by LGDT.
          dw gdt64_limit ; GDT limit ...
          dq gdt64_base ; and 64-bit GDT base
pIDT64 label tbyte ; Used by LIDT.
```

```

                dw      idt64_limit    ; IDT limit ...
                dq      idt64_base    ; and 64-bit IDT base
mydata ends      ; end of data segment
code16 segment para use16 ; 16-bit code segment
; ~~~~~
; 16-bit code, real mode
;
; ~~~~~
; Initialize DS to point to the data segment containing
; pGDT32 and PIDT32. Set up a real-mode stack pointer, SS:SP,
; in case of interrupts and exceptions.
;
cli
mov  ax, seg mydata
mov  ds, ax
mov  ax, seg mystack
mov  ss, ax
mov  sp, esp0
;
; Use CPUID to determine if the processor supports long mode. ;

mov  eax, 80000000h ; Extended-function 80000000h.
cpuid                ; Is largest extended function
cmp  eax, 80000000h ; any function > 80000000h?
jbe  no_long_mode   ; If not, no long mode.
mov  eax, 80000001h ; Extended-function 80000001h.
cpuid                ; Now EDX = extended-features flags.
bt   edx, 29         ; Test if long mode is supported.
jnc  no_long_mode   ; Exit if not supported.
;
; Load the 32-bit GDT before entering protected mode.
; This GDT must contain, at a minimum, the following
; descriptors:
; 1) a CPL=0 16-bit code descriptor for this code segment.
; 2) a CPL=0 32/64-bit code descriptor for the 64-bit code.
; 3) a CPL=0 read/write data segment, usable as a stack
; (referenced by SS).
;
; Load the 32-bit IDT, in case any interrupts or exceptions
; occur after entering protected mode, but before enabling
; long mode).
;
; Initialize the GDTR and IDTR to point to the temporary
; 32-bit GDT and IDT, respectively.
;
lgdt  ds:[pGDT32]
lidt  ds:[pIDT32]
;
; Enable protected mode (CR0.PE=1).
;

```

```

    mov    eax, 000000011h
    mov    cr0, eax
;
; Execute a far jump to turn protected mode on.
; code16_sel must point to the previously-established 16-bit
; code descriptor located in the GDT (for the code currently
; being executed).
;
    db    0eah                ;Far jump...
    dw    offset now_in_prot;to offset...
    dw    code16_sel          ;in current code segment.
;
; At this point we are in 16-bit protected mode, but long
; mode is still disabled.
;
;
;
now_in_prot:
;
; Set up the protected-mode stack pointer, SS:ESP.
; Stack_sel must point to the previously-established stack
; descriptor (read/write data segment), located in the GDT.
; Skip setting DS/ES/FS/GS, because we are jumping right to
; 64-bit code.
;
    mov    ax, stack_sel
    mov    ss, ax
    mov    esp, esp0
;
; Enable the 64-bit page-translation-table entries by
; setting CR4.PAE=1 (this is _required_ before activating
; long mode). Paging is not enabled until after long mode
; is enabled.
;
    mov    eax, cr4
    bts    eax, 5
    mov    cr4, eax
;
; Create the long-mode page tables, and initialize the
; 64-bit CR3 (page-table base address) to point to the base
; of the PML4 page table. The PML4 page table must be located
; below 4 Gbytes because only 32 bits of CR3 are loaded when
; the processor is not in 64-bit mode.
;
    mov    eax, pml4_base ; Pointer to PML4 table (<4GB).
    mov    cr3, eax      ; Initialize CR3 with PML4 base.
;
; Enable long mode (set EFER.LME=1).
;
    mov    ecx, 0c0000080h ; EFER MSR number.
    rdmsr ; Read EFER.
    bts    eax, 8          ; Set LME=1.

```



```

; Load the 64-bit IDT. This is _required_, because the 64-bit
; IDT uses 64-bit interrupt descriptors, while the 32-bit
; IDT used 32-bit interrupt descriptors. pIDT64_linear is
; the _linear_ address of the 10-byte IDT pseudo-descriptor.
;
    lidt    [pIDT64_linear]
;
; Set the current TSS. tss_sel should point to a 64-bit TSS
; descriptor in the current GDT. The TSS is used for
; inner-level stack pointers and the IO bit-map.
;
    mov    ax, tss_sel
    ltr    ax
;
; Set the current LDT. ldt_sel should point to a 64-bit LDT
; descriptor in the current GDT.
;
    mov    ax, ldt_sel
    lldt   ax
;
; Using fs: and gs: prefixes on memory accesses still uses
; the 32-bit fs.base and gs.base. Reload these 2 registers
; before using the fs: and gs: prefixes. FS and GS can be
; loaded from the GDT using a normal "mov fs,foo" type
; instructions, which loads a 32-bit base into FS or GS.
; Alternatively, use WRMSR to assign 64-bit base values to
; MSR_FS_base or MSR_GS_base.
;
    mov    ecx, MSR_FS_base
    mov    eax, FsbaseLow
    mov    edx, FsbaseHi
    wrmsr
;
; Reload CR3 if long-mode page tables are to be located above
; 4 Gbytes. Because the original CR3 load was done in 32-bit
; legacy mode, it could only load 32 bits into CR3. Thus, the
; current page tables are located in the lower 4 Gbytes of
; physical memory. This MOV to CR3 is only needed if the
; actual long-mode page tables should be located at a linear
; address above 4 Gbytes.
;
    mov    rax, final_pml4_base ; Point to PML4
    mov    cr3, rax             ; Load 64-bit CR3
;
; Enable interrupts.
;
    sti                                ; Enabled INTR
    <insert 64-bit code here>

```

15 Secure Virtual Machine

AMD Virtualization™ (AMD-V™) architecture is designed to provide enterprise-class server virtualization software technology that facilitates virtualization development and deployment. An SVM enabled virtual machine architecture should provide hardware resources that allow a single machine to run multiple operating systems efficiently, while maintaining secure, resource-guaranteed isolation.

15.1 The Virtual Machine Monitor

A *virtual machine monitor* (VMM), also known as a *hypervisor*, consists of software that controls the execution of multiple *guest* operating systems on a single physical machine. The VMM provides each guest the appearance of full control over a complete computer system (memory, CPU, and all peripheral devices). The use of the term *host* refers to the execution context of the VMM. *World switch* refers to the operation of switching between the host and guest.

Fundamentally, VMMs work by *intercepting* and emulating in a safe manner sensitive operations in the guest (such as changing the page tables, which could give a guest access to memory it is not allowed to access). The AMD SVM provides hardware assists to improve performance and facilitate implementation of virtualization.

15.2 SVM Hardware Overview

SVM processor support provides a set of hardware extensions designed to enable economical and efficient implementation of virtual machine systems. Generally speaking, hardware support falls into two complementary categories: *virtualization* support and *security* support.

15.2.1 Virtualization Support

The AMD virtual machine architecture is designed to provide:

- Mechanisms for fast world switch between VMM and guest
- The ability to intercept selected instructions or events in the guest
- External (DMA) access protection for memory.
- Assists for interrupt handling and virtual interrupt support
- A guest/host tagged TLB to reduce virtualization overhead.

15.2.2 Guest Mode

This new processor mode is entered through the VMRUN instruction. When in guest mode, the behavior of some x86 instructions changes to facilitate virtualization.

15.2.3 External Access Protection

Guests may be granted direct access to selected I/O devices. Hardware support is designed to prevent devices owned by one guest from accessing memory owned by another guest (or the VMM).

15.2.4 Tagged TLB

In the SVM usage model, the VMM is mapped in a different address space than the guest. To reduce the cost of world switches, the TLB is tagged with an address space identifier (ASID) distinguishing host-space entries from guest-space entries.

15.2.5 Interrupt Support

To facilitate efficient virtualization of interrupts, the following support is provided under control of VMCB flags:

Intercepting physical interrupt delivery. The VMM can request that physical interrupts cause a running guest to exit, allowing the VMM to process the interrupt.

Virtual interrupts. The VMM can inject virtual interrupts into the guest. Under control of the VMM, a virtual copy of the EFLAGS.IF interrupt mask bit, and a virtual copy of the APIC's task priority register are used transparently by the guest instead of the physical resources.

Sharing a physical APIC. SVM allows multiple guests to share a physical APIC while guarding against malicious or defective guests that might leave high-priority interrupts unacknowledged forever (and thus shut out other guest's interrupts).

15.2.6 Restartable Instructions

SVM is designed to safely restart, with the exception of task switches, any intercepted instruction (either atomic or idempotent) after the intercept.

15.2.7 Security Support

To further enable secure initialization SVM provides additional System support.

Attestation. The SKINIT instruction and associated system support (the Trusted Platform Module, or TPM) allow for verifiable startup of trusted software (such as a VMM), based on secure hash comparison.

15.3 SVM Processor and Platform Extensions

This section describes the operation of the SVM hardware extensions. These extensions can be grouped into the following categories:

- State switch—VMRUN, VMSAVE, VMLOAD instructions, global interrupt flag (GIF), and instructions to manipulate the latter (STGI, CLGI). (“VMRUN Instruction” on page 369,

“VMSAVE and VMLOAD Instructions” on page 388, “Global Interrupt Flag, STGI and CLGI Instructions” on page 390.)

- Intercepts—allow the VMM to intercept sensitive operations in the guest. (“Intercept Operation” on page 375 through “Miscellaneous Intercepts” on page 388)
- Interrupt and APIC assists—physical interrupt intercepts, virtual interrupt support, APIC.TPR virtualization. (“Global Interrupt Flag, STGI and CLGI Instructions” on page 390 and “Interrupt and Local APIC Support” on page 393)
- SMM intercepts and assists (“SMM Support” on page 396)
- External (DMA) access protection (“External Access Protection” on page 399)
- Nested paging support for two levels of address translation. (“Nested Paging” on page 406)
- Security—SKINIT instruction. (“Secure Startup with SKINIT” on page 414)

15.4 Enabling SVM

The VMRUN, VMLOAD, VMSAVE, CLGI, VMSCALL, and INVLPGA instructions can be used when the EFER.SVME is set to 1; otherwise, these instructions generate a #UD exception. The SKINIT and STGI instructions can be used when either the EFER.SVME bit is set to 1 or the ECX.SKINIT bit, as returned by CPUID function 8000_0001h, is set to 1; otherwise, these instructions generate a #UD exception.

Before enabling SVM, software should detect whether SVM can be enabled using the following algorithm:

```
if (CPUID 8000_0001.ECX[SVM] == 0)
    return SVM_NOT_AVAIL;

if (VM_CR.SVMDIS == 0)
    return SVM_ALLOWED;

if (CPUID 8000_000A.EDX[SVM_LOCK]==0)
    return SVM_DISABLED_AT_BIOS_NOT_UNLOCKABLE
    // the user must change a BIOS setting to enable SVM
else return SVM_DISABLED_WITH_KEY;
    // SVMLock may be ununlockable; consult the BIOS or TPM to obtain the key.
```

15.5 VMRUN Instruction

The VMRUN instruction is the cornerstone of SVM. VMRUN takes, as a single argument, the physical address of a 4KB-aligned page, the *virtual machine control block* (VMCB), which describes a virtual machine (guest) to be executed. The VMCB contains:

- a list of instructions or events in the guest (e.g., write to CR3) to intercept,

- various control bits that specify the execution environment of the guest or that indicate special actions to be taken before running guest code, and
- guest processor state (such as control registers, etc.).

15.5.1 Basic Operation

The VMRUN instruction has an implicit addressing mode of [rAX]. Software must load RAX (EAX in 32-bit mode) with the physical address of the VMCB, a 4-Kbyte-aligned page that describes a virtual machine to be executed. The portion of RAX used in forming the address is determined by the current effective address size.

The VMCB is accessed by physical address and should be mapped as writeback (WB) memory.

VMRUN is available only at CPL-0. A #GP exception is raised if the CPL is greater than 0. Furthermore, the processor must be in protected mode and EFER.SVME must be set to 1, otherwise, a #UD exception is raised.

The VMRUN instruction saves some host processor state information in the host state-save area in main memory at the physical address specified in the VM_HSAVE_PA MSR; it then loads corresponding guest state from the VMCB state-save area. VMRUN also reads additional control bits from the VMCB that allow the VMM to flush the guest TLB, inject virtual interrupts into the guest, etc.

The VMRUN instruction then checks the guest state just loaded. If an illegal state has been loaded, the processor exits back to the host (see “#VMEXIT” on page 374).

Otherwise, the processor now runs the guest code until an intercept event occurs, at which point the processor suspends guest execution and resumes host execution at the instruction following the VMRUN. This is called a #VMEXIT and is described in detail in “#VMEXIT” on page 374.

VMRUN saves or restores a minimal amount of state information to allow the VMM to resume execution after a guest has exited. This allows the VMM to handle simple intercept conditions quickly. If additional guest state information must be saved or restored (e.g., to handle more complex intercepts or to switch to a different guest), the VMM can employ the VMSAVE and VMLOAD instructions (see “VMSAVE and VMLOAD Instructions” on page 388).

Saving Host State. To assure that the host can resume operation after #VMEXIT, VMRUN saves at least the following host state information at the physical address specified in the new MSR VM_HSAVE_PA:

- CS.SEL, NEXT_RIP—The CS selector and rIP of the instruction following the VMRUN. On #VMEXIT the host resumes running at this address.
- RFLAGS, RAX—Host processor mode and the register used by VMRUN to address the VMCB.
- SS.SEL, RSP—Stack pointer for host.
- CR0, CR3, CR4, EFER—Paging/operating mode for host.
- IDTR, GDTR—The pseudo-descriptors. VMRUN does not save or restore the host LDTR.

- ES.SEL and DS.SEL.

Processor implementations may store only part or none of host state in the memory area pointed to by VM_HSAVE_PA MSR and may store some or all host state in hidden on-chip memory. Different implementations may choose to save the hidden parts of the host's segment registers as well as the selectors. For these reasons, software must not rely on the format or contents of the host state save area, nor attempt to change host state by modifying the contents of the host save area.

Loading Guest State. After saving host state, VMRUN loads the following guest state from the VMCB:

- CS, rIP—Guest begins execution at this address. The hidden state of the CS segment register is also loaded from the VMCB.
- RFLAGS, RAX.
- SS, RSP—Includes the hidden state of the SS segment register.
- CR0, CR2, CR3, CR4, EFER—Guest paging mode. Writing paging-related control registers with VMRUN does *not* flush the TLB since address spaces are switched. See Section 15.15, “TLB Control,” on page 389.
- INTERRUPT_SHADOW—This flag indicates whether the guest is currently in an interrupt lockout shadow; see “Interrupt Shadows” on page 395.
- IDTR, GDTR.
- ES and DS—Includes the hidden state of the segment registers.
- DR7 and DR6—The guest's breakpoint state.
- V_TPR—The guest's virtual TPR.
- V_IRQ—The flag indicating whether a virtual interrupt is pending in the guest.
- CPL—If the guest is in real mode, the CPL is forced to 0; if the guest is in v86 mode, the CPL is forced to 3. Otherwise, the CPL saved in the VMCB is used.

The processor checks the loaded guest state for consistency. If a consistency check fails while loading guest state, the processor performs a #VMEXIT. For additional information, see “Canonicalization and Consistency Checks” on page 373.

If the guest is in PAE paging mode according to the registers just loaded, the processor will also read the four PDPEs pointed to by the newly loaded CR3 value; setting any reserved bits in the PDPEs also causes a #VMEXIT.

It is possible for the VMRUN instruction to load a guest rIP that is outside the limit of the guest code segment or that is non-canonical (if running in long mode). If this occurs, a #GP fault is delivered inside the guest; the rIP falling outside the limit of the guest code segment is not considered illegal guest state.

After all guest state is loaded, and intercepts and other control bits are set up, the processor reenables interrupts by setting GIF to 1. It is assumed that VMM software cleared GIF some time before executing the VMRUN instruction, to ensure an atomic state switch.

Control Bits. Besides loading guest state, the VMRUN instruction reads various control fields from the VMCB; most of these fields are not written back to the VMCB on #VMEXIT, since they cannot change during guest execution:

- TSC_OFFSET—an offset to add when the guest reads the TSC (time stamp counter). Guest writes to the TSC can be intercepted and emulated by changing the offset (without writing the physical TSC). This offset is cleared when the guest exits back to the host.
- V_INTR_PRIO, V_INTR_VECTOR, V_IGN_TPR—fields used to describe a virtual interrupt for the guest (see “Injecting Virtual (INTR) Interrupts” on page 394).
- V_INTR_MASKING—controls whether masking of interrupts (in EFLAGS.IF and TPR) is to be virtualized (see Section 15.20 on page 393).
- The address space ID (ASID) to use while running the guest. (See the *CPUID Specification*, order# 25481, for feature identification, including how many ASIDs are implemented.)
- A field to control flushing of the TLB during a VMRUN (see Section 15.15).
- The intercept vector describing the active intercepts for the guest. On exit from the guest, the internal intercept registers are cleared so no host operations will be intercepted.

Segment State in the VMCB. The segment registers are stored in the VMCB in a format similar to that for SMM: both base and limit are fully expanded; segment attributes are stored as 12-bit values formed by the concatenation of bits 55–52 and 47–40 from the original 64-bit (in-memory) segment descriptors; the descriptor “P” bit is used to signal NULL segments (P==0) where permissible and/or relevant. When loaded from the VMCB, only some of the attribute bits are observed by hardware, depending on the segment register in question:

- CS—D, L, R (null code segments are not allowed).
- SS—B, P, DPL, E, W (null stack segments allowed in 64-bit mode only).
- DS, ES, FS, GS —D, P, DPL, E, W, Code/Data.
- LDTR—Only the P bit is observed.
- TR—Only TSS type (32 or 16 bit) is relevant, since a null TSS is not allowed.

The VMM should follow these rules when storing segment attributes into the VMCB:

- For NULL segments, set all attribute bits to zero; otherwise, write the concatenation of bits [55–52] and [47–40] from the original 64-bit (in-memory) segment descriptors.
- The processor reads the current privilege level from the CPL field in the VMCB, not from SS.DPL. However, SS.DPL should match the CPL field.
- When in virtual x86 or real mode, the processor ignores the CPL field in the VMCB and forces the values of 3 and 0, respectively.

When examining segment attributes after a #VMEXIT:

- Test the Present (P) bit to check whether a segment is NULL; note that CS and TR never contain NULL segments and so their P bit is ignored;
- Retrieve the CPL from the CPL field in the VMCB, not from any segment DPL.

Canonicalization and Consistency Checks. The VMRUN instruction performs consistency checks on guest state and #VMEXIT performs the appropriate subset of these consistency checks on host state. Illegal guest state combinations cause a #VMEXIT with error code VMEXIT_INVALID. The following conditions are considered illegal state combinations:

- EFER.SVME is zero.
- CR0.CD is zero and CR0.NW is set.
- CR0[63–32] are not zero.
- Any MBZ bit of CR3 is set.
- CR4[63–11] are not zero.
- DR6[63–32] are not zero.
- DR7[63–32] are not zero.
- EFER[63–15] are not zero.
- EFER.LMA or EFER.LME is non-zero and this processor does not support long mode.
- EFER.LME and CR0.PG are both set and CR4.PAE is zero.
- EFER.LME and CR0.PG are both non-zero and CR0.PE is zero.
- EFER.LME, CR0.PG, CR4.PAE, CS.L, and CS.D are all non-zero.
- The VMRUN intercept bit is clear.
- The MSR or IOIO intercept tables extend to a physical address that is greater than or equal to the maximum supported physical address.
- Illegal event injection (see Section 15.19 on page 391).
- ASID is equal to zero.

VMRUN can load a guest value of CR0 with PE = 0 but PG = 1, a combination that is otherwise illegal (see Section 15.18).

In addition to consistency checks, VMRUN and #VMEXIT canonicalize (i.e., sign-extend to 63 bits) all base addresses in the segment registers that have been loaded.

VMRUN and TF/RF Bits in EFLAGS. When considering interactions of VMRUN with the TF and RF bits in EFLAGS, one must distinguish between the behavior of host as opposed to that of the guest.

From the host point of view, VMRUN acts like a single instruction, even though an arbitrary number of guest instructions may execute before a #VMEXIT effectively completes the VMRUN. As a single host instruction, VMRUN interacts with EFLAGS.RF and EFLAGS.TF like ordinary instructions. EFLAGS.RF suppresses any potential instruction breakpoint match on the VMRUN, and EFLAGS.TF causes a #DB trap after the VMRUN completes on the host side (i.e., after the #VMEXIT from the guest). As with any normal instruction, completion of the VMRUN instruction clears the host EFLAGS.RF bit.

The value of EFLAGS.RF from the VMCB affects the first guest instruction. When VMRUN loads a guest value of 1 for EFLAGS.RF, that value takes effect and suppresses any potential (guest)

instruction breakpoint on the first guest instruction. When VMRUN loads a guest value of 1 in EFLAGS.TF, that value does *not* cause a trace trap between the VMRUN and the first guest instruction, but rather *after* completion of the first guest instruction.

Host values of EFLAGS have no effect on the guest and guest values of EFLAGS have no effect on the host.

See also Section 15.7.1 on page 375 regarding the value of EFLAGS.RF saved on #VMEXIT.

15.6 #VMEXIT

When an intercept triggers, the processor performs a #VMEXIT (i.e., an exit from the guest to the host context).

On #VMEXIT, the processor:

- Disables interrupts by clearing the GIF, so that after the #VMEXIT, VMM software can complete the state switch atomically.
- Writes back to the VMCB the current guest state—the same subset of processor state as is loaded by the VMRUN instruction, including the V_IRQ, V_TPR, and the INTERRUPT_SHADOW bits.
- Saves the reason for exiting the guest in the VMCB's EXITCODE field; additional information may be saved in the EXITINFO1 or EXITINFO2 fields, depending on the intercept.
- Clears all intercepts.
- Resets the current ASID register to zero (host ASID).
- Clears the V_IRQ and V_INTR_MASKING bits inside the processor.
- Clears the TSC_OFFSET inside the processor.
- Reloads the host state previously saved by the VMRUN instruction. The processor reloads the host's CS, SS, DS, and ES segment registers and, if required, re-reads the descriptors from the host's segment descriptor tables, depending on the implementation. The segment descriptor tables must be mapped as present and writable by the host's page tables. Software should keep the host's segment descriptor tables consistent with the segment registers when executing VMRUN instructions. Immediately after #VMEXIT, the processor still contains the guest value for LDTR. So for CS, SS, DS, and ES, the VMM must only use segment descriptors from the global descriptor table. Any exception encountered while reloading the host segments causes a shutdown.
- If the host is in PAE mode, the processor reloads the host's PDPEs from the page table indicated by the host's CR3. If the PDPEs contain illegal state, the processor causes a shutdown.
- Forces CR0.PE = 1, RFLAGS.VM = 0.
- Sets the host CPL to zero.
- Disables all breakpoints in the host DR7 register.
- Checks the reloaded host state for consistency; any error causes the processor to shutdown. If the host's rIP reloaded by #VMEXIT is outside the limit of the host's code segment or non-canonical (in the case of long mode), a #GP fault is delivered inside the host.

15.7 Intercept Operation

Various instructions and events (such as exceptions) in the guest can be intercepted by means of control bits in the VMCB. The two primary classes of intercepts supported by SVM are instruction and exception intercepts.

Exception intercepts. Exception intercepts are checked when normal instruction processing must raise an exception—before resolving possible double-fault conditions according to table 8-3 and before attempting delivery of the exception (which includes pushing an exception frame, accessing the IDT, etc.).

For some exceptions, the processor still writes certain exception-specific registers even if the exception is intercepted. (See the descriptions in Section 15.11 on page 383 and following for details.) When an external or virtual interrupt is intercepted, the interrupt is left pending.

When an intercept occurs while the guest is in the process of delivering a non-intercepted interrupt or exception using the IDT, SVM provides additional information on #VMEXIT (See Section 15.7.2 on page 376).

Instruction intercepts. These occur at well-defined points in instruction execution—before the results of the instruction are committed, but ordered in an intercept-specific priority relative to the instruction's exception checks. Generally, instruction intercepts are checked after simple exceptions (such as #GP when CPL is incorrect, or #UD) have been checked, but before exceptions related to memory accesses (such as page faults) and exceptions based on specific operand values. There are several exceptions to this guideline, e.g., the RSM instruction. Instruction breakpoints for the current instruction and pending data breakpoint traps from the previous instruction are designed to be checked before instruction intercepts.

15.7.1 State Saved on Exit

When triggered, intercepts write an EXITCODE into the VMCB identifying the cause of the intercept. The EXITINTINFO field signals whether the intercept occurred while the guest was attempting to deliver an interrupt or exception through the IDT; a VMM can use this information to transparently complete the delivery (see “Event Injection” on page 391). Some intercepts provide additional information in the EXITINFO1 and EXITINFO2 fields in the VMCB; see the individual intercept descriptions for details.

The guest state saved in the VMCB is the processor state as of the moment the intercept triggers. In the x86 architecture, traps (as opposed to faults) are detected and delivered after the instruction that triggered them has completed execution. Accordingly, a trap intercept takes place after the execution of the instruction that triggered the trap in the first place. The saved guest state thus includes the effects of executing that instruction.

Example: Assume a guest instruction triggers a data breakpoint (#DB) trap which is in turn intercepted. The VMCB records the guest state after execution of that instruction, so that the saved

Despite the instruction name, the events raised by the INT1 (also known as ICEBP), INT3 and INTO instructions (opcodes F1h, CCh and CEh) are considered exceptions for the purposes of EXITINTINFO, not software interrupts. Only events raised by the INT n instruction (opcode CDh) are considered software interrupts.

- Error Code Valid—Bit 11. Set to 1 if the guest exception would have pushed an error code; otherwise cleared to zero.
- Valid—Bit 31. Set to 1 if the intercept occurred while the guest attempted to deliver an exception through the IDT; otherwise cleared to zero.
- Errorcode—Bits 63–32. If EV is set to 1, holds the error code that the guest exception would have pushed; otherwise is undefined.

In the case of multiple exceptions, EXITINTINFO records the aggregate information on all exceptions but the last (intercepted) one.

Example: A guest raises a #GP during delivery of which a #NP is raised (a scenario that, according to x86 rules, resolves to a #DF), and an intercepted #PF occurs during the attempt to deliver the #DF. Upon intercept of the #PF, EXITINTINFO indicates that the guest was in the process of delivering a #DF when the #PF occurred. The information about the intercepted page fault itself is encoded in the EXITCODE, EXITINFO1 and EXITINFO2 fields. If the VMM decides to repair and dismiss the #PF, it can resume guest execution by re-injecting (see “Event Injection” on page 391) the fault recorded in EXITINTINFO. If the VMM decides that the #PF should be reflected back to the guest, it must combine the event in EXITINTINFO with the intercepted exception according to x86 rules (see table 8-3). In this case, a #DF plus a #PF would result in a triple fault or shutdown.

15.7.3 EXITINTINFO Pseudo-Code

When delivering exceptions or interrupts in a guest, the processor checks for exception intercepts and updates the value of EXITINTINFO should an intercept occur during exception delivery. The following pseudo-code outlines how the processor delivers an event (exception or interrupt) E.

```
if E is an exception and is intercepted:
    #VMEXIT(E)
E = (result of combining E with any prior events)

if (result was #DF and #DF is intercepted):
    #VMEXIT(#DF)
if (result was shutdown and shutdown is intercepted):
    #VMEXIT(#shutdown)
EXITINTINFO = E // Record the event the guest is delivering.
```

Attempt delivery of E through the IDT
Note that this may cause secondary exceptions

Once an exception has been successfully taken in the guest:

```
EXITINTINFO.V = 0 // Delivery succeeded; no #VMEXIT.
Dispatch to first instruction of handler
```

When an exception triggers an intercept, the EXITCODE, and optionally EXITINFO1 and EXITINFO2, fields always reflect the intercepted exception, while EXITINTINFO, if marked valid, indicates the prior exception the guest was attempting to deliver when the intercept occurred.

15.8 Instruction Intercepts

Table 15-2 specifies the instructions that check a given intercept and, where relevant, how the intercept is prioritized relative to exceptions.

Table 15-2. Instruction Intercepts

Instruction Intercept	Checked By	Priority
Read/Write of CR0	MOV TO/FROM CR0, LMSW, SMSW, CLTS	Checks non-memory exceptions (CPL, illegal bit combinations, etc.) before the intercept. For LMSW and SMSW, checks SVM intercepts before checking memory exceptions.
Read/Write of CR3 (excluding task switch)	MOV TO/FROM CR3 (not checked by task switch operations)	Checks non-memory exceptions first, then the intercept. If the intercept triggers on a write, the intercept happens <i>before</i> the TLB is flushed. If PAE is enabled, the loading of the four PDPEs can cause a #GP; that exception is checked <i>after</i> the intercept check, so the VMM handling a CR3 intercept cannot rely on the PDPEs being legal; it must examine them in software if necessary. The reads and writes of CR3 that occur in VMRUN, #VMEXIT or task switches are <i>not</i> subject to this intercept check.
Read/Write of other CRs	MOV TO/FROM CR n	All normal exception checks take precedence over the SVM intercepts.
Read/Write of Debug Registers, DR n	MOV TO/FROM DR n . (Not checked by implicit DR6/DR7 writes.)	All normal exception checks take precedence over the SVM intercepts.

Table 15-2. Instruction Intercepts (continued)

Instruction Intercept	Checked By	Priority
Selective CR0 Write Intercept	MOV TO CR0, LMSW	<p>Checks non-memory exceptions (CPL, illegal bit combinations, etc.) before the intercept. For LMSW and SMSW, checks SVM intercepts before checking memory exceptions.</p> <p>The selective write intercept on CR0 triggers only if a bit other than CR0.TS or CR0.MP is being changed by the write. In particular, this means that CLTS does not check this intercept.</p> <p>When both selective and non-selective CR0-write intercepts are active at the same time, the non-selective intercept takes priority. With respect to exceptions, the priority of this intercept is the same as the generic CR0-write intercept.</p> <p>The LMSW instruction treats the selective CR0-write intercept as a non-selective intercept (i.e., it intercepts regardless of the value being written).</p>
Reading or Writing IDTR, GDTR, LDTR, TR	LIDT, SIDT, LGDT, SGDT, LLDT, SLDT, LTR, STR	The SVM intercept is checked after #UD and #GP exception checks, but before any memory access is performed.
RDTSC	RDTSC	Checks all exceptions before the SVM intercept.
RDPMC	RDPMC	Checks all exceptions before the SVM intercept.
PUSHF	PUSHF	Takes priority over any exceptions.
POPF	POPF	Takes priority over any exceptions.
CPUID	CPUID	No exceptions to check.
RSM	RSM	The intercept takes priority over any exceptions.
IRET	IRET	The intercept takes priority over any exceptions.
Software Interrupt	INT n	<p>The intercept occurs before any exceptions are checked. The CS:rIP reported on #VMEXIT are those of the intercepted INTn instruction.</p> <p>Though the INTn instruction may dispatch through IDT vectors in the range of 0–31, those events cannot be intercepted by means of exception intercepts (see “Exception Intercepts” on page 383).</p>
INVD	INVD	Exceptions (#GP) are checked before the intercept.
PAUSE	PAUSE (opcode F3 90h).	No exceptions to check.
HLT	HLT	Checks all exceptions before checking for this intercept.
INVLPG	INVLPG	Checks all exceptions (#GP) before the intercept.
INVLPGA	INVLPGA	Checks all exceptions (#GP) before the intercept.

Table 15-2. Instruction Intercepts (continued)

Instruction Intercept	Checked By	Priority
VMRUN	VMRUN	Checks exceptions (#GP) before the intercept. <i>The current implementation requires that the VMRUN intercept always be set in the VMCB.</i>
VMLOAD	VMLOAD	Checks exceptions (#GP) before the intercept.
VMSAVE	VMSAVE	Checks exceptions (#GP) before the intercept.
VMMCALL	VMMCALL	The intercept takes priority over exceptions. VMMCALL causes #UD in the guest if it is not intercepted.
STGI	STGI	Checks exceptions (#GP) before the intercept.
CLGI	CLGI	Checks exceptions (#GP) before the intercept.
SKINIT	SKINIT	Checks exceptions (#GP) before the intercept.
RDTSCP	RDTSCP	Checks all exceptions before the SVM intercept.
ICEBP	ICEBP(opcode F1h).	Although the ICEBP instruction dispatches through IDT vector 1, that event is not interceptable by means of the #DB exception intercept.
WBINVD	WBINVD	Checks exceptions (#GP) before the intercept.
MONITOR	MONITOR	Checks all exceptions before the intercept.
MWAIT	MWAIT	Checks all exceptions before the intercept. There are conditional and unconditional MWAIT intercepts. The conditional MWAIT intercept is checked before the unconditional MWAIT intercept. When both conditional and unconditional MWAIT intercepts are active, the conditional intercept is checked first. A hypervisor that sets both intercepts will receive the conditional MWAIT intercept exit code for a guest MWAIT instruction that would have entered a low-power state, and will receive the unconditional MWAIT intercept exit code for a guest MWAIT instruction that would not have entered the low-power state.

15.9 IOIO Intercepts

The VMM can intercept IOIO instructions (IN, OUT, INS, OUTS) on a port-by-port basis by means of the SVM I/O permissions map.

I/O Permissions Map. The I/O Permissions Map (IOPM) occupies 12 Kbytes of contiguous physical memory. The table is structured as a linear array of 64K+3 bits (two 4-Kbyte pages, and the first three bits of a third 4-Kbyte page) and must be aligned on a 4-Kbyte boundary; the physical base address of the IOPM is specified in the IOPM_BASE_PA field in the VMCB and loaded into the processor by the VMRUN instruction. The VMRUN instruction ignores the lower 12 bits of the address specified in the

VMCB. If the address of the last byte in the table is greater than or equal to the maximum supported physical address, this is treated as illegal VMCB state and causes a #VMEXIT(VMEXIT_INVALID).

Each bit in the table corresponds to an 8-bit I/O port. Bit 0 in the table corresponds to I/O port 0, bit 1 to I/O port 1 and so on. A bit set to 1 indicates that accesses to the corresponding port should be intercepted. The IOPM is accessed by physical address, and should reside in memory that is mapped as writeback (WB).

IN and OUT Behavior. If the IOIO_PROT intercept bit is set, the IOPM table controls port access. For IN/OUT instructions that access more than a single byte, the permission bits for all bytes are checked; if any bit is set to 1, the I/O operation is intercepted.

Exceptions related to virtual x86 mode, IOPL, or the TSS-bitmap are checked *before* the SVM intercept check. All other exceptions are checked *after* the SVM intercept check.

I/O Intercept Information. When an IOIO intercept triggers, the following information (describing the intercepted operation in order to facilitate emulation) is saved in the VMCB's EXITINFO1 field:

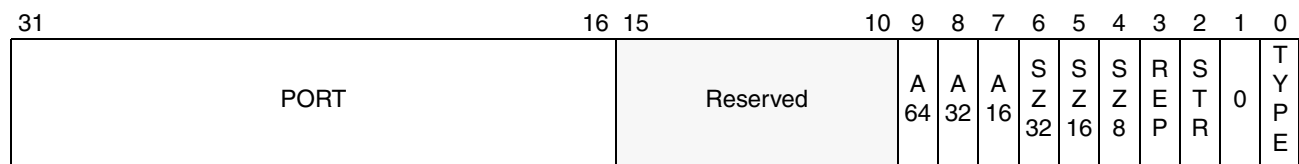

Bits	Mnemonic	Description
31–16	PORT	Intercepted I/O port
15–10	Reserved, SBZ	
9	A64	64-bit address
8	A32	32-bit address
7	A16	16-bit address
6	SZ32	32-bit operand size
5	SZ16	16-bit operand size
4	SZ8	8-bit operand size
3	REP	Repeated port access
2	STR	String based port access (INS, OUTS)
1	0	
0	TYPE	Access Type (0 = OUT instruction, 1 = IN instruction)

Figure 15-2. EXITINFO1 for IOIO Intercept

The RIP of the instruction *following* the IN/OUT is saved in EXITINFO2, so that the VMM can easily resume the guest after I/O emulation.

15.10 MSR Intercepts

The VMM can intercept RDMSR and WRMSR instructions by means of the *SVM MSR permissions map* (MSRPM) on a per-MSR basis.

MSR Permissions Map. The MSR permissions bitmap consists of a number of smaller separate bitmaps of 2K bytes each covering a defined range of 8K MSRs. Four of these smaller bitmaps reside in two physical pages (8KB, covering 32K MSRs). One 8Kbyte range is used for the Pentium[®] compatible MSRs, the next 8K range is used for the AMD sixth generation x86 processor (AMD-K6[®]) MSRs, and the third 8K range for the AMD seventh and eighth generation x86 processors (e.g., the AMD Athlon[™] and AMD Opteron[™]) MSRs. If the MSR_PROT intercept is active, any attempt to read or write an MSR not covered by the bitmap will automatically cause an intercept.

The MSRPM is accessed by physical address, and should reside in memory that is mapped as writeback (WB). The MSRPM must be aligned on a 4KB boundary. The physical base address of the MSRPM is specified in MSRPM_BASE_PA field in the VMCB and is loaded into the processor by the VMRUN instruction. The VMRUN instruction ignores the lower 12 bits of the address specified in the VMCB, and if the address of the last byte in the table is greater than or equal to the maximum supported physical address, this is treated as illegal VMCB state and causes a #VMEXIT(VMEXIT_INVALID).

Table 15-3. Ranges of MSR Permissions Map

Byte Offset	MSR Range	Current Usage
000h–7FFh	0000_0000h–0000_1FFFh	Pentium [®] -compatible MSRs
800h–FFFh	C000_0000h–C000_1FFFh	AMD Sixth Generation x86 Processor MSRs and SYSCALL
1000h–17FFh	C001_0000h–C001_1FFFh	AMD Seventh and Eighth Generation Processor MSRs
1800h–1FFFh	XXXX_XXXX–XXXX_XXXX	reserved

Table 15-3 defines the ranges of the MSR permissions map. For each MSR mapped by the table, two bits are allocated—the lower order of the two bits controls read access to the MSR, and the higher order of the two bits controls write access. A bit value of 1 indicates that the operation is intercepted.

RDMSR and WRMSR Behavior. If the MSR_PROT bit in the VMCB's intercept vector is clear, RDMSR/WRMSR instructions are not intercepted.

RDMSR and WRMSR instructions check for exceptions and intercepts in the following order:

- Exceptions common to all MSRs (e.g., #GP if not at CPL-0)
- Check SVM intercepts in the MSR permission map, if the MSR_PROT intercept is requested.
- Exceptions specific to a given MSR (including password protection, unimplemented MSRs, reserved bits, etc.)

MSR Intercept Information. On #VMEXIT, the processor indicates in the VMCB's EXITINFO1 whether a RDMSR (EXITINFO1 = 0) or WRMSR (EXITINFO1 = 1) was intercepted.

15.11 Exception Intercepts

When intercepting exceptions that define an error code (normally pushed onto the exception stack), the SVM hardware delivers that error code in the VMCB's EXITINFO1 field; the exception vector number can be derived from the EXITCODE. The CS.SEL and rIP saved in the VMCB on an exception-intercept match those that would otherwise have been pushed onto the exception stack frame, except that when an interrupt-based instruction causes an intercept, the rIP of the instruction is stored in the VMCB, rather than the rIP of the next instruction. The interrupt-based instructions are INT3 (opcode CC), INTO, and BOUND.

Unless otherwise noted below, no special registers are written before an exception is intercepted. For details on guest state saved in the VMCB, see Section 15.7.1.

External interrupts and software interrupts (INT n instruction) do not check the exception intercepts, even when they use a vector in the range 0 to 31.

Exceptions that occur during the handling of a prior exception are checked for intercepts *before* being combined with the prior exception (e.g., into a double-fault). If the result of combining exceptions is a double-fault or shutdown, the processor checks whether those are intercepted before attempting delivery.

Example: Assume that the VMM intercepts #GP and #DF exceptions, and the guest raises a (non-intercepted) #NP, during the delivery of which it also gets a #GP (e.g., due to an illegal IDT entry)—a situation that, according to x86 semantics, results in a #DF. In this case, #VMEXIT signals an intercepted #GP, *not* an intercepted #DF and fills EXITINTINFO with the #NP fault. On the other hand, if only the #DF intercept were active in this scenario, #VMEXIT would signal an intercepted #DF.

The following subsections detail the individual intercepts.

#DE (Divide By Zero)

The EXITINFO1 and EXITINFO2 fields are undefined.

#DB (Debug)

The #DB exception can have fault-type (e.g., instruction breakpoint) or trap-type (e.g., data breakpoint) behavior; accordingly the intercept differs in what state is saved in the VMCB (see “State Saved on Exit” on page 375). In either case, however, the value saved for DR6 and DR7 matches what would be visible to a #DB exception handler (i.e., both #DB faults and traps are permitted to write DR6 and DR7 before the intercept). The EXITINFO1 and EXITINFO2 fields are undefined.

Fault-type #DB exceptions, whether indicated in EXITCODE or EXITINTINFO, cause the CS:rIP saved in the VMCB to indicate the instruction that caused the #DB exception. Trap-type #DB exceptions cause the VMCB's CS:rIP to indicate the instruction following the instruction that caused the exception. A vector 1 exception generated by the single byte INT1 instruction (also known as

ICEBP) does not trigger the #DB intercept. Software should use the dedicated ICEBP intercept to intercept ICEBP (see “Instruction Intercepts” on page 378).

15.11.1 Vector 2 (Reserved)

This intercept bit is not implemented; use the NMI intercept (Section 15.12.2) instead. The effect of setting this bit is undefined.

15.11.2 #BP (Breakpoint)

This intercept applies to the trap raised by the single byte INT3 (opcode CCh) instruction. The EXITINFO1 and EXITINFO2 fields are undefined. The CS:rIP reported on #VMEXIT are those of the INT3 instruction.

15.11.3 #OF (Overflow)

This intercept applies to the trap raised by the INTO (opcode CEh) instruction. The EXITINFO1 and EXITINFO2 fields are undefined.

15.11.4 #BR (Bound-Range)

This intercept applies to the fault raised by the BOUND instruction. The EXITINFO1 and EXITINFO2 fields are undefined.

15.11.5 #UD (Invalid Opcode)

The EXITINFO1 and EXITINFO2 fields are undefined.

15.11.6 #NM (Device-Not-Available)

The EXITINFO1 and EXITINFO2 fields are undefined.

15.11.7 #DF (Double Fault)

The EXITINFO1 and EXITINFO2 fields are undefined. The rIP value saved in the VMCB is undefined (as is the case for the rIP value pushed on the stack for #DF exceptions). If a double fault is intercepted, the exceptions leading up to the double fault will have written any status registers normally written by those exceptions.

15.11.8 Vector 9 (Reserved)

This intercept is not implemented. The effect of setting this bit is undefined.

15.11.9 #TS (Invalid TSS)

The EXITINFO1 and EXITINFO2 fields are undefined. The rIP value saved in the VMCB may point to either the instruction causing the task switch, or to the first instruction of the incoming task. See “Task Switch Intercept” on page 388 for information in the EXITINFO1 and EXITINFO2 fields.

15.11.10 #NP (Segment Not Present)

The EXITINFO1 field contains the error code that would be pushed on the stack by a #NP exception. The EXITINFO2 field is undefined.

15.11.11 #SS (Stack Fault)

The EXITINFO1 field contains the error code that would be pushed on the stack by a #SS exception. The EXITINFO2 field is undefined.

15.11.12 #GP (General Protection)

The EXITINFO1 field contains the error code that would be pushed on the stack by a #GP exception.

15.11.13 #PF (Page Fault)

This intercept is tested *before* CR2 is written by the exception. The error code saved in EXITINFO1 is the same as would be pushed onto the stack by a non-intercepted #PF exception in protected mode. The faulting address is saved in the EXITINFO2 field in the VMCB. Even when the guest is running in paged real mode, the processor will deliver the (protected-mode) page-fault error code in EXITINFO1, for the VMM to use in analyzing the intercepted #PF.

15.11.14 #MF (X87 Floating Point)

This intercept is tested *after* the floating point status word has been written, as is the case for a normal FP exception. The EXITINFO1 and EXITINFO2 fields are undefined.

15.11.15 #AC (Alignment Check)

The EXITINFO1 field contains the error code that would be pushed on the stack by an #AC exception. The EXITINFO2 field is undefined.

15.11.16 #MC (Machine Check)

The SVM intercept is checked after all #MC-specific registers have been written, but before other guest state is modified. When #MC is being intercepted, a machine-check exits to the VMM, whenever possible, and shuts down the processor only when this is not a reasonable option. The EXITINFO1 and EXITINFO2 fields are undefined.

15.11.17 #XF (SIMD Floating Point)

This intercept is tested after the SIMD status word (MXCSR) has been written, as is the case for a normal FP exception. The EXITINFO1 and EXITINFO2 fields are undefined.

15.12 Interrupt Intercepts

External interrupts, when intercepted, cause a #VMEXIT; the interrupt is held pending so that the interrupt can eventually be taken in the VMM. Exception intercepts do not apply to external or software interrupts, so it is not possible to intercept an interrupt by means of the exception intercepts, even if the interrupt should happen to use a vector in the range from 0 to 31.

15.12.1 INTR Intercept

This intercept affects physical, as opposed to virtual, maskable interrupts. See “Virtual Interrupt Intercept” on page 395 for virtualization of maskable interrupts.

15.12.2 NMI Intercept

This intercept affects non-maskable interrupts.

15.12.3 SMI Intercept

This intercept affects System Management Mode Interrupts (SMIs); see “SMM Support” on page 396 for details on SMI handling.

When this intercept triggers, bit 0 of the EXITINFO1 field distinguishes whether the SMI was caused internally by I/O Trapping (bit 0 = 0), or asserted externally (bit 0 = 1).

If the SMI was asserted while the guest was executing an I/O instruction, extra information (describing the I/O instruction) is saved in the upper 32 bits of EXITINFO1, and the rIP of the I/O instruction is saved in EXITINFO2. EXITINFO1 indicates that SMI was asserted during an I/O instruction when the VALID bit is set.

If the SMI wasn't asserted during an I/O instruction, the extra EXITINFO1 and EXITINFO2 bits are undefined.

The SMI intercept is ignored when HWCR.SMMLOCK is set.

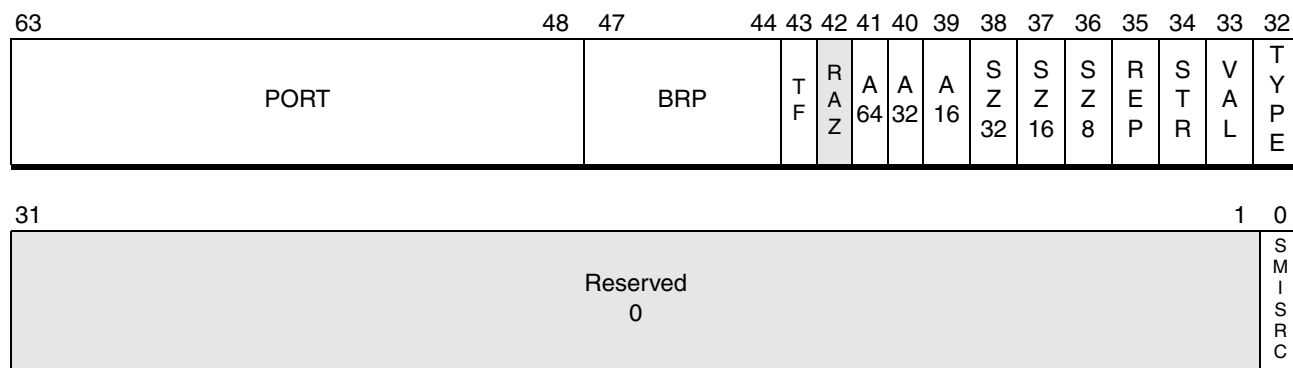

Bits	Mnemonic	Description
63–48	PORT	Intercepted I/O port
47–44	BRP	I/O breakpoint matches
43	TF	EFLAGS TF value
42	Reserved, RAZ	
41	A64	64-bit address
40	A32	32-bit address
39	A16	16-bit address
38	SZ32	32-bit operand size
37	SZ16	16-bit operand size
36	SZ8	8-bit operand size
35	REP	Repeated port access
34	STR	String based port access (INS, OUTS)
33	VAL	Valid (SMI was detected during an I/O instruction)
32	TYPE	Access Type (0 = OUT instruction, 1 = IN instruction)
31–1	Reserved, 0	
0	SMISRC	SMI source (0 = internal, 1 = external)

Figure 15-3. EXITINFO1 for SMI Intercept

15.12.4 INIT Intercept

The INIT intercept allows the VMM to intercept the assertion of INIT while a guest is running; see “INIT Support” on page 395 for a discussion of the INIT-redirection feature.

15.12.5 Virtual Interrupt Intercept

This intercept is taken just before a guest takes a virtual interrupt. When the intercept triggers, the virtual interrupt has not been taken, and remains pending in the guest's VMCB V_IRQ field. This intercept is not required for handling fixed local APIC interrupts, but may be used for emulating ExtINT interrupt delivery mode (which is not masked by the TPR), or legacy PICs in auto-EOI mode.

15.13 Miscellaneous Intercepts

The SVM architecture includes intercepts to handle task switches, processor freezes due to FERR, and shutdown operations.

15.13.1 Task Switch Intercept

Checked by—Any instruction or event that causes a task switch (e.g., JMP, CALL, exceptions, interrupts, software interrupts).

Priority—The intercept is checked before the task switch takes place but *after* the incoming TSS and task gate (if one was involved) have been checked for correctness.

Task switches can modify several resources that a VMM may want to protect (CR3, EFLAGS, LDT). However, instead of checking various intercepts (e.g., CR3 Write, LDTR Write) individually, task switches check only a single intercept bit.

On #VMEXIT, the following information is delivered in the VMCB:

- EXITINFO1[15–0] holds the segment selector identifying the incoming TSS.
- EXITINFO2[31–0] holds the error code to push in the new task, if applicable; otherwise, this field is undefined.
- EXITINFO2[63–32] holds auxiliary information for the VMM:
 - EXITINFO2[36]—Set to 1 if the task switch was caused by an IRET; else cleared to 0.
 - EXITINFO2[38]—Set to 1 if the task switch was caused by a far jump; else cleared to 0.
 - EXITINFO2[44]—Set to 1 if the task switch has an error code; else cleared to 0.
 - EXITINFO2[48]—The value of EFLAGS.RF that would be saved in the outgoing TSS if the task switch were not intercepted.

15.13.2 Ferr_Freeze Intercept

Checked when the processor freezes due to assertion of FERR (while IGNNE is deasserted, and legacy handling of FERR is selected in CR0.NE), i.e., while the processor is waiting to be unfrozen by an external interrupt.

15.13.3 Shutdown Intercept

When this intercept occurs, any condition that normally causes a shutdown causes a #VMEXIT to the VMM instead. After an intercepted shutdown, the state saved in the VMCB is undefined.

15.14 VMSAVE and VMLOAD Instructions

The VMSAVE and VMLOAD instructions take the physical address of a VMCB in rAX. These instructions complement the state save/restore abilities of VMRUN instruction and #VMEXIT. They

provide access to hidden processor state that software cannot otherwise access, as well as additional privileged state.

VMSAVE saves the following state to the VMCB indicated by rAX:

- FS, GS, TR, LDTR (including all hidden state)
- KernelGsBase
- STAR, LSTAR, CSTAR, SFMASK
- SYSENTER_CS, SYSENTER_ESP, SYSENTER_EIP

VMLOAD loads the corresponding state from the VMCB. VMLOAD and VMSAVE are available only at CPL-0 (#GP otherwise), and in protected mode with SVM enabled in EFER.SVME (#UD otherwise).

15.15 TLB Control

TLB entries are tagged with *Address Space Identifier* (ASID) bits to distinguish different host and/or guest address spaces. The VMM can choose a software strategy in which it keeps multiple shadow page tables (SPTs) and/or multiple nested page tables in processors that support nested paging up-to-date; the VMM can allocate a different ASID for each SPT or nested page table. (See Section 15.24, “Nested Paging,” on page 406.) This allows switching to a new process in a guest (i.e., a new CR3 value, which means a new SPT or nested page table) without flushing the TLBs.

For each guest address space, the VMM is responsible for setting up a shadow page table or nested page table that maps guest linear addresses to system physical addresses. In shadow paging, the VMM should set the CR3 field in the guest VMCB to point to the system physical address of this shadow page table. The VMM is responsible for updating the shadow page table when the guest changes the page table or paging control state, and the VMM should update the access and dirty bits of the guest page table.

The VMRUN instruction and #VMEXIT write the CR0, CR3, CR4 and EFER registers — these writes do *not* flush the TLB. The VMM is responsible for explicitly invalidating any guest translations that may be affected by its actions; there are two mechanisms available, as described in the next two sections.

When running with SVM enabled, global page table entries (PTEs) are global only *within* an ASID, not across ASIDs.

Software Rule. When the VMM changes a guest’s paging mode by changing entries in the guest’s VMCB, the VMM must ensure that the guest’s TLB entries are flushed from the TLB. The relevant VMCB state includes:

- CR0—PG, WP, CD, NW.
- CR3—Any bit.
- CR4—PGE, PAE, PSE.

- EFER—NXE, LMA, LME.

15.15.1 TLB Flush

TLB flush operations function identically whether or not SVM is enabled (e.g., MOV-TO-CR3 flushes non-global mappings, whereas MOV-TO-CR4 flushes global and non-global mappings). TLB flush operations must not be assumed to affect all ASIDs. If a VMM sets the intercept bit for any guest action that would have flushed the TLB, the #VMEXIT intercept occurs and the TLB is not flushed; it is the VMM's responsibility to flush the TLB appropriately. In implementations that do not provide a way to selectively flush all translations of a single specified ASID, software may effectively flush the guest's TLB entries by allocating a new ASID for the guest and not reusing the old ASID until the entire TLB has been flushed at least once.

The TLB_CONTROL field in the VMCB currently has one command implemented. When the VMM sets the TLB_CONTROL field to 1, the VMRUN instruction flushes the TLB for all ASIDs, for both global and non-global pages. The VMRUN instruction reads, but does not change, the value of the TLB_CONTROL field.

15.15.2 Invalidate Page, Alternate ASID

A new instruction, INVLPGA, allows the VMM to selectively invalidate the TLB mapping for a given virtual page and a given ASID. The linear address is specified in the implicit register operand rAX; the ASID is specified in ECX.

15.16 Global Interrupt Flag, STGI and CLGI Instructions

The global interrupt flag (GIF) is a bit that controls whether interrupts and other events can be taken by the processor. The STGI and CLGI instructions set and clear, respectively, the GIF. Table 15-4 shows how the value of the GIF affects how interrupts and exceptions are handled.

Table 15-4. Effect of the GIF on Interrupt Handling

Interrupt source	GIF==0	GIF ==1
Debug exception or trap, due to breakpoint register match	Ignored and discarded	Normal operation
Debug trace trap due to EFLAGS.TF	Normal operation	Normal operation
RESET#	Normal operation	Normal operation
INIT	Held pending until GIF==1	Normal operation, see Table 15-6 on page 396
NMI	Held pending until GIF==1	Normal operation, see Table 15-7 on page 396
External SMI	Held pending until GIF==1	Normal operation, see Table 15-8 on page 397
Internal SMI (I/O Trapping)	Ignored and discarded	Normal operation, see Table 15-8 on page 397
INTR and vINTR	Held pending until GIF==1	Normal operation

Table 15-4. Effect of the GIF on Interrupt Handling (continued)

Interrupt source	GIF==0	GIF ==1
#SX (Security Exception)	n/a ¹	Normal operation
Machine Check	If possible (implementation-dependent), held pending until GIF==1, otherwise shutdown.	Normal operation
DBREQ# (enter HDT)	Normal operation	Normal operation
	(VM_CR.DPD always controls DBREQ)	
A20M	Normal operation	Normal operation
	(VM_CR.DIS_A20M controls A20 masking)	
Other implementation-specific but non-architecturally-visible interrupts (STPCLK, IGNNE toggle, ECC scrub)	Normal operation	Normal operation
Note:		
1. #SX is caused only by an INIT signal that has been “redirected” (i.e., converted to an #SX; see Section 15.27 on page 419); the conversion only happens when GIF==1, as the INIT is simply held pending otherwise.		

15.17 VMSCALL Instruction

This instruction is meant as a way for a guest to explicitly call the VMM. No CPL checks are performed, so the VMM can decide whether to make this instruction legal at the user-level or not.

If VMSCALL instruction is not intercepted, the instruction raises a #UD exception.

15.18 Paged Real Mode

To facilitate virtualization of real mode, the VMRUN instruction may legally load a guest CR0 value with PE = 0 but PG = 1. Likewise, the RSM instruction is permitted to return to paged real mode. This processor mode behaves in every way like real mode, with the exception that paging is applied. The intent is that the VMM run the guest in paged-real mode at CPL0, and with page faults intercepted. The VMM is responsible for setting up a shadow page table that maps guest *physical* memory to the appropriate system physical addresses.

The behavior of running a guest in paged real mode without intercepting page faults to the VMM is undefined.

15.19 Event Injection

The VMM can inject exceptions or interrupts (collectively referred to as events) into the guest by setting bits in the VMCB’s EVENTINJ field prior to executing the VMRUN instruction. The format of the field is shown in Table 15-4 on page 392. The encoding matches that of the EXITINTINFO field.

When an event is injected by means of this mechanism, the VMRUN instruction causes the guest to unconditionally take the specified exception or interrupt before executing the first guest instruction.

Injected events are treated in every way as though they had occurred normally in the guest (in particular, they are recorded in EXITINTINFO) with the following exceptions:

- Injected events are not subject to intercept checks. (Note, however, that if secondary exceptions occur during delivery of an injected event, those exceptions *are* subject to exception intercepts.)
- An injected NMI does not block delivery of further NMIs.
- If the VMM attempts to inject an event that is impossible for the guest mode (e.g., a #BR exception when the guest is in 64-bit mode), the event injection will fail and no guest state instructions will be executed; VMRUN will immediately exit with an error code of VMEXIT_INVALID.

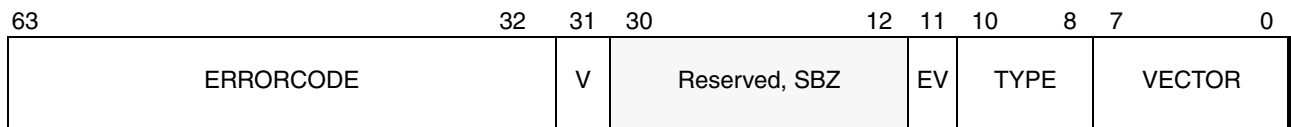

Figure 15-4. EVENTINJ Field in the VMCB

The fields in EVENTINJ are as follows:

- *VECTOR*—Bits 7–0. The 8-bit IDT vector of the interrupt or exception. If TYPE is 2 (NMI), the VECTOR field is ignored.
- *TYPE*—Bits 10–8. Qualifies the guest exception or interrupt to generate. Table 15-5 shows possible values and their corresponding interrupt or exception types. Values not indicated are unused and reserved.

Table 15-5. Guest Exception or Interrupt Types

Value	Type
0	External or virtual interrupt (INTR)
2	NMI
3	Exception (fault or trap)
4	Software interrupt (INT n instruction)

- *EV (Error Code Valid)*—Bit 11. Set to 1 if the exception should push an error code onto the stack; clear to 0 otherwise.
- *V (Valid)*—Bit 31. Set to 1 if an event is to be injected into the guest; clear to 0 otherwise.
- *ERRORCODE*—Bits 63–32. If EV is set to 1, the error code to be pushed onto the stack, ignored otherwise. Injecting an exception (TYPE = 3) with vectors 3 or 4 behaves like a trap raised by INT3 and INTO instructions, respectively, in which case the processor checks the DPL of the IDT descriptor before dispatching to the handler.

VMRUN exits with VMEXIT_INVALID if either:

- Reserved values of TYPE have been specified, or
- TYPE = 3 (exception) has been specified with a vector that does not correspond to an exception (this includes vector 2, which is an NMI, not an exception).

15.20 Interrupt and Local APIC Support

SVM hardware support is designed to ensure efficient virtualization of interrupts.

15.20.1 Physical (INTR) Interrupt Masking in EFLAGS

To prevent the guest from blocking maskable interrupts (INTR), SVM provides a VMCB control bit, V_INTR_MASKING, which changes the operation of EFLAGS.IF and accesses to the TPR by means of the CR8 register. While running a guest with V_INTR_MASKING cleared to zero:

- EFLAGS.IF controls both virtual and physical interrupts.

While running a guest with V_INTR_MASKING set to 1:

- The host EFLAGS.IF at the time of the VMRUN is saved and controls physical interrupts while the guest is running.
- The guest value of EFLAGS.IF controls virtual interrupts only.

15.20.2 Virtualizing APIC.TPR

SVM provides a virtual TPR register, V_TPR, for use by the guest; its value is loaded from the VMCB by VMRUN and written back to the VMCB by #VMEXIT. The APIC's TPR always controls the task priority for physical interrupts, and the V_TPR always controls virtual interrupts.

While running a guest with V_INTR_MASKING cleared to 0:

- Writes to CR8 affect both the APIC's TPR and the V_TPR register.
- Reads from CR8 operate as they would without SVM.

While running a guest with V_INTR_MASKING set to 1:

- Writes to CR8 affect only the V_TPR register.
- Reads from CR8 return V_TPR.

15.20.3 TPR Access in 32-Bit Mode

The mechanism for TPR virtualization described in Section 15.20.2 applies only to accesses that are performed using the CR8 register. However, in 32-bit mode, the TPR is traditionally accessible only by using a memory-mapped register. Typically, a VMM virtualizes such TPR accesses by not mapping the APIC page addresses in the guest. A guest access to that region then causes a #PF intercept to the VMM, which inspects the guest page tables to determine the physical address and, after recognizing the physical address as belonging to the APIC, finally invokes software emulation code.

To improve the efficiency of TPR accesses in 32-bit mode, SVM makes CR8 available to 32-bit code by means of an alternate encoding of MOV TO/FROM CR8 (namely, MOV TO/FROM CR0 with a LOCK prefix). To achieve better performance, 32-bit guests should be modified to use this access method, instead of the memory-mapped TPR. (For details, see “MOV (CRn)” on page 286 of the *AMD64 Programmer’s Reference Volume 3: General Purpose and System Instructions*, order# 24594.)

The alternate encodings of the MOV TO/FROM CR8 instructions are available even if SVM is disabled in EFER.SVME. They are available in both 64-bit and 32-bit mode.

15.20.4 Injecting Virtual (INTR) Interrupts

Virtual Interrupts allow the host to pass an interrupt (#INTR) to a guest. While inside a guest, the virtual interrupt follows the same rules that a real interrupt follows (virtual #INTR is not taken until EFLAGS.IF is 1, the guest's TPR has enabled interrupts at the same priority as that of the pending virtual interrupt).

SVM provides an efficient mechanism by which the VMM can inject virtual interrupts into a guest:

- As described in Section 15.12.1, the VMM can intercept physical interrupts that arrive while a guest is running, by activating the INTR intercept in the VMCB.
- As described in Section 15.20.4, the VMM can virtualize the interrupt masking logic by setting the V_INTR_MASKING bit in the VMCB.
- The three VMCB fields V_IRQ, V_INTR_PRIO, and V_INTR_VECTOR indicate whether there is a virtual interrupt pending, and, if so, what its vector number and priority are. The VMRUN instruction loads this information into corresponding on-chip registers.
- The processor takes a virtual INTR interrupt if
 - V_IRQ and V_INTR_PRIO indicate that there is a virtual interrupt pending whose priority is greater than the value in V_TPR,
 - interrupts are enabled in EFLAGS.IF,
 - interrupts are enabled using GIF, and
 - the processor is not in an interrupt shadow (see Section 15.20.5 on page 395).

The only other difference between virtual INTR handling and normal interrupt handling is that, in the latter case, the interrupt vector is obtained from the V_INTR_VECTOR register (as opposed to running an INTAK cycle to the local APIC).

- The V_IGN_TPR field in the VMCB can be set to indicate that the currently pending virtual interrupt is not subject to masking by TPR. The priority comparison against V_TPR is omitted in this case. This mechanism can be used to inject ExtINT-type interrupts into the guest.
- When the processor dispatches a virtual interrupt (through the IDT), V_IRQ is cleared after checking for intercepts of virtual interrupts and before the IDT is accessed.
- On #VMEXIT, V_IRQ is written back to the VMCB, allowing the VMM to track whether a virtual interrupt has been taken.

- Physical interrupts take priority over virtual interrupts, whether they are taken directly or through a #VMEXIT.
- On #VMEXIT, the processor clears its internal copies of V_IRQ and V_INTR_MASKING, so virtual interrupts do not remain pending in the VMM, and interrupt control reverts to normal.

15.20.5 Interrupt Shadows

The x86 architecture defines the notion of an *interrupt shadow*—a single-instruction window during which interrupts are not recognized. For example, the instruction after an STI instruction that sets EFLAGS.IF (from zero to one) does not recognize interrupts or certain debug traps. The VMCB INTERRUPT_SHADOW field indicates whether the guest is currently in an interrupt shadow. This information is saved on #VMEXIT and loaded on VMRUN.

15.20.6 Virtual Interrupt Intercept

When virtualizing interrupt handling, a VMM typically needs only gain control when new interrupts for a guest arrive or are generated, and when the guest issues an EOI (end-of-interrupt). In some circumstances, it may also be necessary for the VMM to gain control at the moment interrupts become enabled in the guest (i.e., just before the guest takes a virtual interrupt). The VMM can do so by enabling the VINTR intercept.

15.20.7 Interrupt Masking in Local APIC

When guests have direct access to devices, interrupts arriving at the local APIC can usually be dismissed only by the guest that owns the device causing the interrupt. To prevent one guest from blocking other guests' interrupts (by never processing their own), the VMM can mask pending interrupts in the local APIC, so they do not participate in the prioritization of other interrupts.

SVM introduces the following APIC features:

- A 256-bit IER (interrupt enable) register is added to the local APIC. This register resets to all ones (enabling all 256 vectors). Software can read and write the IER by means of the memory-mapped APIC page.
- Only vectors that are enabled in the IER participate in the APIC computation of the highest-priority pending interrupt.
- The VMM can issue specific end-of-interrupt (EOI) commands to the local APIC, allowing the VMM to clear pending interrupts in any order, rather than always targeting the interrupt with highest-priority.

15.20.8 INIT Support

The INIT signal interrupts the processor at the next instruction boundary and causes an unconditional control transfer. INIT reinitializes the control registers, segment registers and GP registers in a manner similar to RESET#, but does not alter the contents of most MSRs, caches or numeric coprocessor (x87 or SSE) state, and then transfers control to the same instruction address as RESET# (physical address

FFFFFFF0h). Unlike RESET#, INIT is not expected to be visible to the memory controller, and hence will not trigger automatic clearing of trusted memory pages by memory controller hardware.

To maintain the security of such pages, the VMM can request that INITs be redirected and turned into #SX exceptions by setting the R_INIT bit in the VM_CR MSR (see Section 15.28.1, “VM_CR MSR (C001_0114h),” on page 420). This allows the VMM to gain control when an INIT is requested. The VMM may thus disable the redirection of INIT and then cause the platform to reassert INIT, at which point the processor will respond in the normal manner. The actions initiated by the INIT pin may also be initiated by an incoming APIC INIT interrupt; the mechanisms described here apply in either case. Table 15-6 summarizes the handling of INITs.

Table 15-6. INIT Handling in Different Operating Modes

GIF	INIT Intercept	INIT Redirect	Processor Response to INIT
0	x	x	Hold pending until GIF = 1.
1	1	x	#VMEXIT(INIT), INIT is still pending.
	0	0	Taken normally.
		1	#SX, INIT is no longer pending.

15.20.9 NMI Support

The VMM can intercept non-maskable interrupts (NMI) using a VMCB control bit (see Table 15-7). When intercepted, NMIs cause an exit from the guest and are held pending.

Table 15-7. NMI Handling in Different Operating Modes

GIF	NMI Intercept	Processor Response to NMI
0	X	Hold pending until GIF=1.
1	1	#VMEXIT(NMI), NMI is still pending.
	0	Taken normally.

15.21 SMM Support

This section describes SVM support for virtualization of System Management Mode (SMM).

15.21.1 Sources of SMI

Various events can cause an assertion of a system management interrupt (SMI); these are classified into three categories

- Internal, synchronous (also known as I/O Trapping)—implementation-specific IOIO or config space trapping in the CPU itself; always synchronous in response to an IN or OUT instruction. I/O Trapping is set up by means of MSRs and can be brought under the control of the VMM by intercepting guest access to those MSRs.

- External, synchronous—IOIO trapping in response to (and synchronous with) IN or OUT instructions, but generated by an external agent (typically the Southbridge).
- External, asynchronous—generated externally in response to an external, physical event, e.g., closing a laptop lid, temperature sensor triggering, etc.

15.21.2 Response to SMI

How hardware responds to SMIs is a function of whether SMM interrupts are being intercepted and whether interrupts are enabled globally, as shown in Table 15-8.

Table 15-8. SMI Handling in Different Operating Modes

GIF	Intercept SMI	Internal SMI	External SMI
0	x	Lost.	Hold pending until GIF=1.
1	1	Exit guest, code #VMEXIT(SMI), SMI is not pending.	#VMEXIT(SMI), SMI is still pending.
	0	Taken normally.	Taken normally.

By intercepting SMIs, the VMM can gain control before the processor enters SMM.

15.21.3 Containerizing Platform SMM

In some usage scenarios, the VMM may not trust the existing platform SMM code, or may otherwise want to ensure that the SMM does not operate in the context of certain guests or the hypervisor. To address these cases, SVM provides the ability to *containerize* SMM code, i.e., run it inside a guest, with the full protection mechanisms of the VMM in place. In other scenarios, the VMM may not want to exert control over SMM.

There are three solutions for the VMM to control SMM handlers:

- The simplest solution is to not intercept SMI signals. SMIs encountered while in a guest context are taken from within the guest context. In this case, the SMM handler is not subject to any intercepts set up by the VMM and consequently runs outside of the virtualization controls. The state saved in the SMM State-Save area as seen by the SMM handler reflects the state of the guest that had been running at the time the SMI was encountered. When the SMM handler executes the RSM instruction, the processor returns to executing in the guest context, and any modifications to the SMM State-Save area made by the SMM handler is reflected in the guest state.
- A hypervisor may want to emulate all SMI-based I/O interceptions for a guest and to take SMI signals only in the hypervisor context. The hypervisor should set all IOIO intercept bits and the SMI intercept bit for the guest to ensure that there is no possibility of encountering synchronous (internal or external) SMI signals while running the guest. Any #VMEXIT(SMI) encountered is then known to be due to an external, asynchronous SMI. The hypervisor may respond to the #VMEXIT(SMI) by executing the STGI instruction, which causes the pending SMI to be taken immediately. When an SMI due to an I/O instruction is pending, the effect of executing STGI in the

hypervisor is undefined. To handle a pending SMI due to an I/O instruction, the hypervisor must either containerize SMM or not intercept SMI.

- The most involved solution is to containerize SMM by placing it in a guest. Containerizing gives the VMM full control over the state that the SMM handler can access.

Containerizing Platform SMM. A VMM can containerize SMM by creating its own trusted SMM hypervisor and use that handler to run the platform SMM code in a container. The SMM hypervisor may be the same code as the VMM itself, or may be an entirely different set of code. The trusted SMM hypervisor sets up a guest context to run the platform SMM as a guest. The guest context consists of a VMCB and related state and the guest's (real or virtual) SMM save area. The SMM hypervisor emulates SMM entry, including setup of the SMM save area, and emulates RSM at the end of SMM operation. The guest executes the platform SMM code in paged real mode with appropriate SVM intercepts in place, thus ensuring security.

For this approach to work, the VMM may need to write the SMM_BASE MSR, as well as related SMM control registers. As part of the emulation of SMM entry and RSM, the VMM needs to access the SMM_CTL MSR (see Section 15.28.3, “SMM_CTL MSR (C001_0116h),” on page 421). However, these actions conflict with any BIOS that locks SMM control registers.

A VMM can determine if it is running with a compatible BIOS setup by checking the SMMLOCK bit in the HWCER MSR (described in the applicable BIOS and Kernel Developer's Guide for your processor). If the bit is 1, the BIOS has locked the SMM control registers and the VMM is unable to move them or insert its own SMM hypervisor.

As the processor physically enters SMM, the SMRAM regions are remapped. The VMM design must ensure that none of its code or data disappears when the SMRAM areas are mapped or unmapped. Also note that the ASEG region of the SMRAM overlaps with a portion of video memory, so the SMM hypervisor should not attempt to write diagnostic messages to the screen. Any attempt by guests to relocate any of the SMRAM areas (by means of certain MSR writes) must also be intercepted to prevent malicious SMM code from interfering with VMM operation.

Writes to the SMM_CTL MSR cause a #GP if the BIOS has locked the SMM control registers.

15.22 Last Branch Record Virtualization

The AMD64 debug control MSR (DebugCtl) provides the processor control of control-transfer recording and other debug tasks. (See Chapter 13, “Debug and Performance Resources,” on page 327, for more detailed information on these subjects.) Software sets the last-branch record (DebugCtl.LBR) bit to 1 to cause the processor to record the source and target addresses of the last control transfer taken before a debug exception. These control transfers include branch instructions, interrupts, and exceptions. Recorded information is stored in four MSRs:

- LastBranchFromIP—Holds the segment offset of the source instruction pointer (rIP).
- LastBranchToIP—Holds the segment offset of the target rIP.

- LastExceptionFromIP—Updated with the previous value of LastBranchFromIP during interrupts and exceptions (except #DB exceptions caused by debug breakpoint and ICEBP).
- LastExceptionToIP—Updated with the previous value of LastBranchToIP during interrupts and exceptions (except #DB exceptions caused by debug breakpoint and ICEBP).

Under SVM, the contents of the control-transfer recording MSRs must be exchanged between values tracked by host and guest. This is done by activating LBR virtualization in the guest VMCB control area.

15.22.1 Enabling LBR Virtualization

Setting the LBR_VIRTUALIZATION_ENABLE bit to 1 in the VMCB control area enables LBR virtualization. When LBR virtualization is enabled, the VMM stores an image of the DebugCtl MSR and of each of the pointers stored in the control-transfer recording MSRs in four fields in the VMCB state save area.

- DBGCTL—Holds the guest value of the DebugCTL MSR.
- BR_FROM—Holds the guest value of the LastBranchFromIP MSR.
- BR_TO—Holds the guest value of the LastBranchToIP MSR.
- LASTEXCPCFROM—Holds the guest value of the LastExceptionToIP MSR.
- LASTEXCPTO—Holds the guest value of the LastExceptionFromIP MSR.

15.22.2 Host and Guest LBR Virtualization

When VMCB.LBR_VIRTUALIZATION_ENABLE[0] is set, VMRUN saves all five host control-transfer MSRs in the host save area, and then loads the same five MSRS for the guest from the VMCB save area. Similarly, #VMEXIT saves the guest's MSRs and loads the host's MSRs to and from their respective save areas.

15.22.3 LBR Virtualization CPUID Feature Detection

EDX bit 1 as returned by CPUID function 8000_000Ah reports the LBR virtualization feature on AMD64 processors.

15.23 External Access Protection

By securing the virtual address translation mechanism, the VMM can restrict guest CPU accesses to memory. However, should the guest have direct access to DMA-capable devices, an additional protection mechanism is required. SVM provides multiple protection domains which can restrict device access to physical memory on a per-page basis. This is accomplished via control logic in the Northbridge's host bridge which governs any external access port (e.g., PCI or HyperTransport™ technology interfaces).

15.23.1 Device IDs and Protection Domains

The Northbridge's host bridge provides a number of protection domains. Each protection domain has associated with it a device exclusion vector (DEV) that specifies the per-page access rights of devices in that domain. Devices are identified by a HyperTransport™ bus/unitID (device ID) and the host bridge contains a lookup table of fixed size that maps device IDs to a protection domain.

15.23.2 Device Exclusion Vector (DEV)

A DEV is a contiguous array of bits in physical memory; each bit in the DEV (in little-endian order) corresponds to one 4-Kbyte page in physical memory.

The physical address of the base of a DEV must be 4-Kbyte-aligned and stored in one of the DEVBASE registers, which are accessed through an indirection mechanism in the DEVCTL PCI Configuration Space function block in the host bridge (see “DEV Control and Status Registers” on page 404). The DEV protection hardware is not operational until enabled by setting a control bit in the DEV Control Register, also in the DEVCTL function block.

The DEV may have to cover part of MMIO space beyond the DRAM. Especially in 64-bit systems, the operating system should map MMIO space starting immediately after the DRAM area and building up, as opposed to starting down from the maximum physical address.

Host Bridge and Processor DEV Caching. For improved performance, the host bridge may cache portions of the DEV. Any such cached information can be invalidated by setting the DEV_FLUSH flag in the DEV control register to 1. Software must set this flag after modifying DEV contents to ensure that the protection logic uses the updated values. The host bridge automatically clears this flag when the flush operation completes. After setting this flag, software should monitor it until it has cleared, in order to synchronize DEV updates with subsequent activity.

By default, the host bridge probes the processor caches for the latest data when it accesses the DEV in DRAM. However, it is possible to disable probing by means of the DEV_CR register (see “DEV_CR Register” on page 404); this is recommended in the case of unified memory architecture (UMA) graphics systems. If cache probing is disabled, host bridge reads of the DEV will not check processor caches for more recent copies. This requires software on the CPU to map the memory containing the DEV as uncacheable (UC) or write-through (WT). Alternatively, software must perform a CLFLUSH before it can expect a change to the DEV to be visible by the Northbridge (and before software flushes the DEV cache in the host controller).

Multiprocessor Issues. Device-originated memory requests are checked against the DEV at the point of entry to the system—the Northbridge to which the device is physically attached. Each Northbridge can have its own set of domains, device-to-domain mappings, and DEV tables (e.g., domain #2 on one node can encompass different devices, and can have different access rights than domain #2 on another node). Thus, the number of protection domains available to software can scale with the number of Northbridges in the system.

15.23.3 Access Checking

Memory Space Accesses. When a memory-space read or write request is received on an external host bridge port, the host bridge maps the HyperTransport bus device ID to a protection domain number, which in turn selects the DEV defining the access permissions for the device (see Figure 15-5 on page 402). The host bridge then checks the memory address against the DEV contents by indexing into the DEV with the PFN portion of the address (bits 39–12). The PFN is used as a bit index within the DEV. If the bit read from the DEV is set to 1, the host bridge inhibits the access by returning all ones for the data for a read request, or suppressing the store operation on a write request. A Master Abort error response will be returned to the requesting device.

Peer-to-peer memory accesses routed up to the host bridge are also subjected to checks against the DEV. Peer-to-peer transfers that may be occurring behind bridges are not checked.

DEV checks are applied before addresses are translated by the GART. The DEV table is never consulted by accesses originating in the CPU.

I/O Space Accesses. The host bridge can be configured to reject all I/O space accesses from devices, by setting the IOSPE bit in the DEV_CR control register (see “DEV_CR Register” on page 404). I/O space peer-to-peer transfers behind bridges are not checked.

Config Space Accesses. Major aspects of host bridge functionality are configured by means of control registers that are accessed through PCI configuration space. Because this is potentially accessible by means of device peer-to-peer transfers, the host bridge always blocks access to this space from anything other than the CPU.

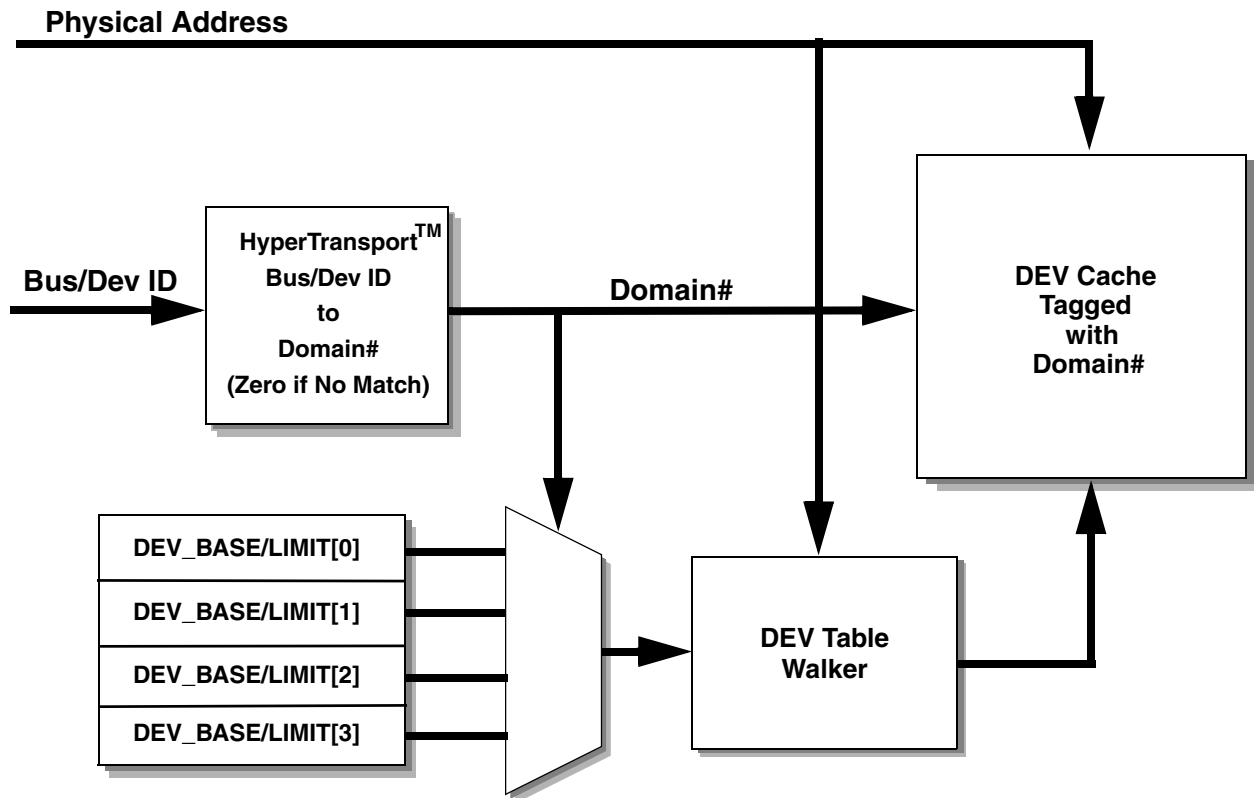

Figure 15-5. Host Bridge DMA Checking

15.23.4 DEV Capability Block

The presence of DEV support is indicated through a new PCI capability block. The capability block also provides access to the registers that control operation of the DEV feature.

The DEV capability block in PCI space contains three 32-bit words: the capability header (DEV_HDR), and two registers (DEV_OP and DEV_DATA) which serve as an indirection mechanism for accessing the actual DEV control and status registers.

Table 15-9. DEV Capability Block, Overall Layout

Byte Offset	Register	Comments
0	DEV_HDR	Capability block header
4	DEV_OP	Selects control/status register to access
8	DEV_DATA	Read/write to access register selected in DEV_OP

DEV Capability Header. The DEV capability header (DEV_HDR) is defined in Table 15-10.

Table 15-10. DEV Capability Header (DEV_HDR) (in PCI Config Space)

Bit(s)	Definition
31–22	Reserved, MBZ
21	Interrupt Reporting Capability
20	Machine Check Exception Reporting Capability
19	Reserved, MBZ
18–16	DEV Capability Block Type; hardwired to 000b.
15–8	PCI Capability pointer; points to next capability in list
7–0	PCI Capability ID; hardwired to 0x0F

15.23.5 DEV Register Access Mechanism

The Northbridge's DEV control and status registers are accessed through an indirection mechanism: writing the DEV_OP register selects which internal register is to be accessed, and the DEV_DATA register can be read or written to access the selected register.

Figure 15-6 shows the format of the DEV_OP register. The DEV_DATA register reflects the format of the DEV register selected in DEV_OP.



Figure 15-6. Format of DEV_OP Register (in PCI Config Space)

The FUNCTION field in the DEV_OP register selects the function/register to read or write according to the encoding in Table 15-11; for blocks of registers that have multiple instances (e.g., multiple DEV_BASE_HI/LO registers), the INDEX field selects the instance; otherwise it is ignored.

Table 15-11. Encoding of Function Field in DEV_OP Register

Function Code	RegisterType	Number of Instances
0	DEV_BASE_LO	multiple
1	DEV_BASE_HI	multiple
2	DEV_MAP	multiple
3	DEV_CAP	single
4	DEV_CR	single
5	DEV_ERR_STATUS	single
6	DEV_ERR_ADDR_LO	single
7	DEV_ERR_ADDR_HI	single

For example, to write the DEV_BASE_HI register for protection domain number 2, software sets DEV_OP.FUNCTION to 1, and DEV_OP.INDEX to 2, and then writes the desired 32-bit value into DEV_DATA. As the DEV_OP and DEV_DATA registers are accessed through PCI config space (ports 0CF8h–0CFFh), they may be secured from unauthorized access by software executing on the processor by appropriate settings in the SVM I/O protection bitmap. These registers are also protected by the host bridge from external access as described in “Config Space Accesses” on page 401.

15.23.6 DEV Control and Status Registers

The DEV control and status registers are accessible by means of the indirection mechanism; these registers are *not* directly visible in PCI config space.

DEV_CAP Register. Read-only register; holds implementation specific information: the number of protection domains supported, the number of DEV_MAP registers (which map device/unit IDs to domain numbers), and the revision ID.

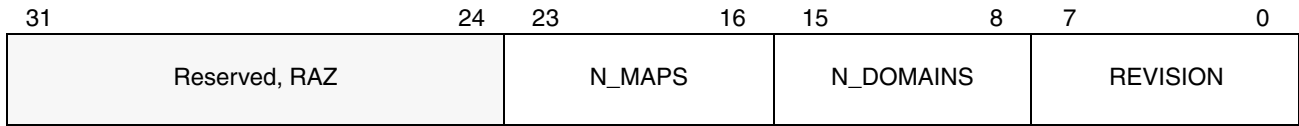

Figure 15-7. Format of DEV_CAP Register (in PCI Config Space)

The initial implementation provide four domains and three map registers.

DEV_CR Register. This is the main control register for the DEV mechanism; it is cleared to zero by RESET.

Table 15-12. DEV_CR Control Register

Bit(s)	Definition
31-7	Reserved, MBZ
6	DEV table walk probe disable. 0 = Use probe on DEV walk; 1 = Do not use probe
5	SL_DEV_EN. Enable bit for limited memory protection, see Section 15.23.8 on page 406. Set to “1” by SKINIT instruction, can be cleared by software.
4	Invalidate DEV cache. Software must set this bit to 1 to invalidate the DEV cache; cleared by hardware when invalidation is complete.
3	Enable MCE reporting. 0 = Do not generate MCE; 1 = Generate MCE on errors.
2	I/O space protection enable (IOSPEN) 0 = Allow upstream I/O cycles; 1 = Block.
1	Memory clear disable. If non-zero, memory-clearing on reset is disabled. This bit is not writable until the memory is enabled.
0	DEV global enable bit. If zero, DEV protection is turned off.

DEV_BASE Address/Limit Registers. The DEV base address registers (one set per domain) each point to the physical address of a DEV table corresponding to a protection domain. The address and size are encoded in a pair (high/low) of 32-bit registers. The N_DOMAINS field in DEV_CAP indicates how many (pairs of) DEV_BASE registers are implemented. The register format is as shown in Figures 15-8 and 15-9.



Figure 15-8. Format of DEV_BASE_HI[n] Registers

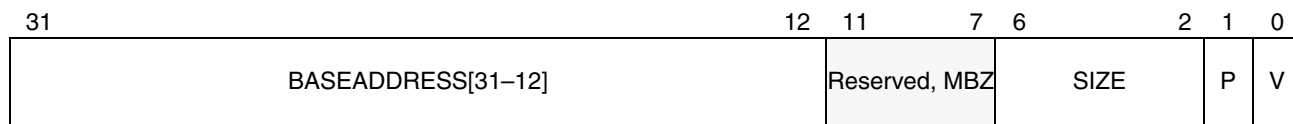

Figure 15-9. Format of DEV_BASE_LO[n] Registers

Fields of the DEV_BASE_HI and DEV_BASE_LO registers are defined as follows:

- *Valid (V)*—Bit 0. Indicates whether a DEV table has been defined for the given protection domain; if this bit is clear, software can leave the other fields undefined, and no protection checks are performed for memory references in this domain.
- *Protect (P)*—Bit 1. Indicates whether accesses to addresses beyond the address range covered by the DEV are legal (P=0) or illegal (P=1).
- *SIZE*—Bits 6–2. Specifies how much memory the DEV covers, expressed increments of 4GB * 2^{size} . In other words, a DEV table covers a minimum of 4GB, and can expand by powers of two.

DEV_MAP Registers. The DEV_MAP registers assign protection domain numbers to device-originated requests by matching the device ID (HT bus and unit number) associated with the request against bus and unit numbers in the registers. If no match is found in any of the registers, a domain number of zero is returned. The number of DEV_MAP registers implemented by the chip is indicated by the N_MAPS field in DEV_CAP.

The format of the DEV_MAP registers is shown in Figure 15-10.

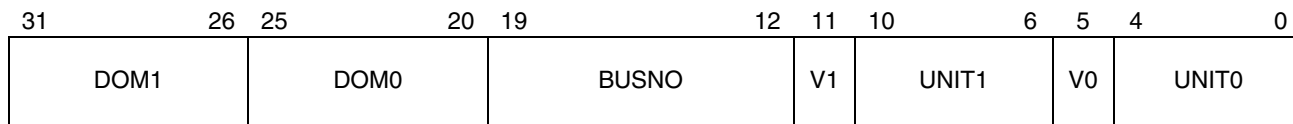

Figure 15-10. Format of DEV_MAP[n] Registers

The fields of the DEV_MAP[*n*] registers are defined as follows:

- UNIT0—Bits 4–0. Specifies the first of two HyperTransport link unit numbers on the bus number specified by the BUSNO field.
- V0—Bit 5. Indicates whether UNIT0 is valid (no matches occur on invalid entries).
- UNIT1—Bits 10–6. Specifies the second of two HyperTransport link unit numbers on the bus number specified by the BUSNO field.
- V1—Bit 11. Indicates whether UNIT1 is valid (no matches occur on invalid entries).
- BUSNO—Bits 19–12. Specifies a HyperTransport link bus number.
- DOM0—Bits 25–20. Specifies the protection domain for the first HyperTransport link unit.
- DOM1—Bits 31–26. Specifies the protection domain for the second HyperTransport link unit.

15.23.7 Unauthorized Access Logging

Any attempted unauthorized access by devices to DEV-protected memory is logged by the host bridge in the DEV_Error_Status and DEV_Error_Address registers for possible inspection by the VMM.

15.23.8 Secure Initialization Support

The host bridge contains additional logic that operates in conjunction with the SKINIT instruction to provide a limited form of memory protection during the secure startup protocol. This provides protection for a Secure Loader image in memory, allowing it to, among other things, set up full DEV protection. (See “Secure Startup with SKINIT” on page 414 for detailed operation of SKINIT.)

The host bridge logic includes a hidden (not accessible to software) SL_DEV_BASE address register. SL_DEV_BASE points to a 64KB-aligned 64KB region of physical memory. When SL_DEV_EN is 1, the 64KB region defined by SL_DEV_BASE is protected from external access (as if it were protected by the DEV), as well as from any access (both CPU and external accesses) via GART-translated addresses. Additionally, the SL_DEV mechanism, when enabled, blocks all device accesses to PCI Configuration space.

15.24 Nested Paging

The optional SVM nested paging feature provides for two levels of address translation, thus eliminating the need for the VMM to maintain shadow page tables.

15.24.1 Traditional Paging versus Nested Paging

Figure 15-11 on page 407 shows how a page in the linear address space is mapped to a page in the physical address space in traditional (single-level) address translation. Control register CR3 contains the physical address of the base of the page tables (PT, represented by the shaded box in the figure), which governs the address translation.

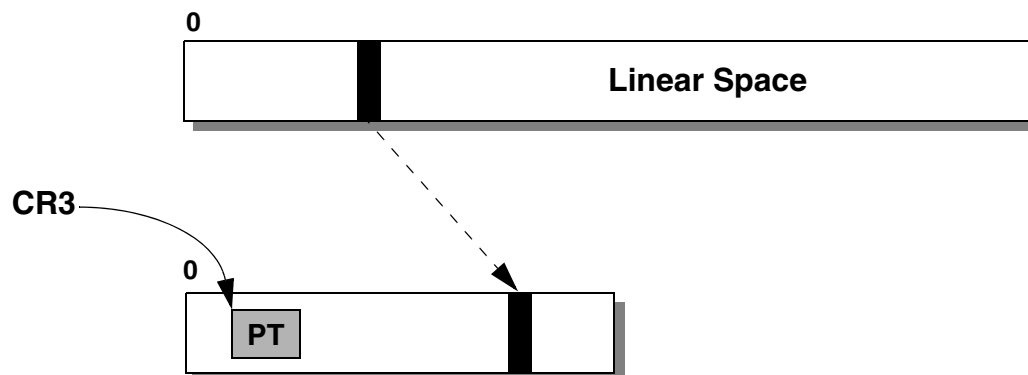

Figure 15-11. Address Translation with Traditional Paging

With nested paging enabled, *two* levels of address translation are applied; refer to Figure 15-12 below.

- Both guest and host levels have their own copy of CR3, referred to as gCR3 and nCR3, respectively.
- Guest page tables (gPT) map guest linear addresses to guest physical addresses. The guest page tables are in guest physical memory, and are pointed to by gCR3.
- Nested page tables (nPT) map guest physical addresses to system physical addresses. The nested page tables are in system physical memory, and are pointed to by nCR3.
- The most-recently used translations from guest linear to system physical address are cached in the TLB and used on subsequent guest accesses.

It is important to note that gCR3 and the guest page table entries contain guest physical addresses, not system physical addresses. Hence, before accessing a guest page table entry, the table walker first translates that entry's guest physical address into a system physical address.

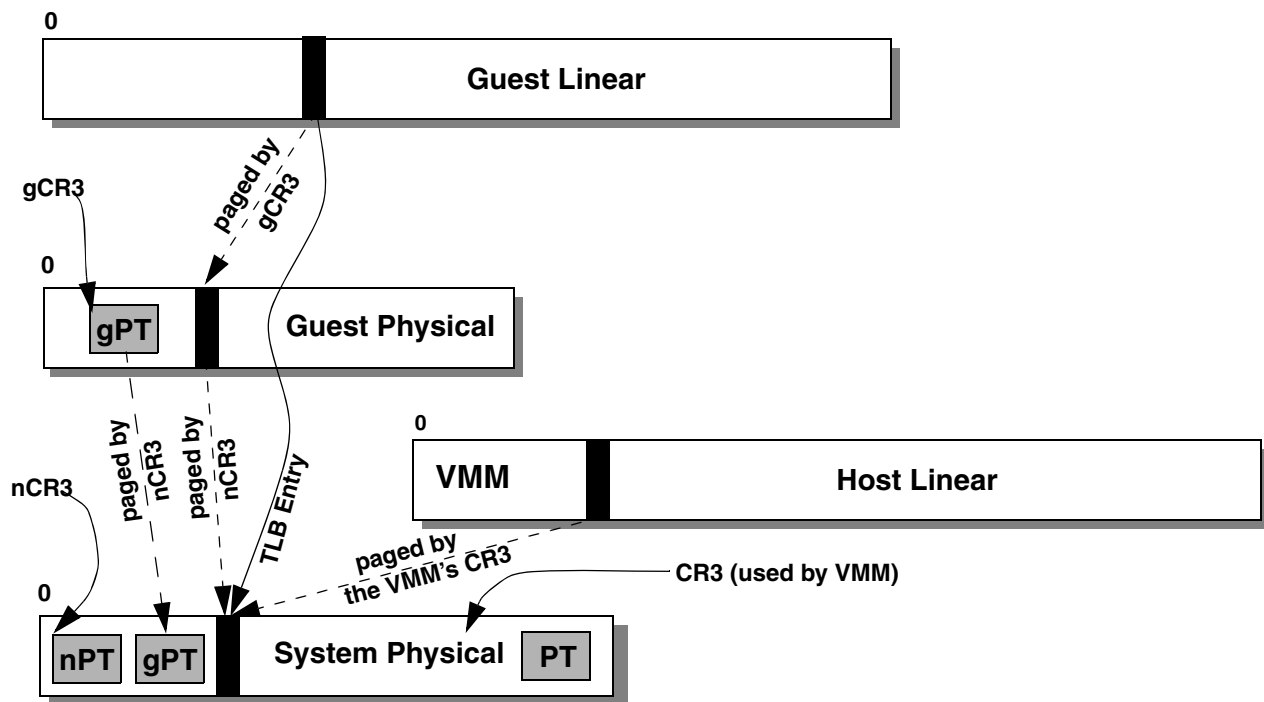

Figure 15-12. Address Translation with Nested Paging

The VMM can give each guest a different ASID, so that TLB entries from different guests can coexist in the TLB. The ASID value of zero is reserved for the host; if the VMM attempts to execute VMRUN with a guest ASID of zero, the result is `#VMEXIT(VMEXIT_INVALID)`.

15.24.2 Replicated State

Most processor state affecting paging is replicated for host and guest. This includes the paging registers CR0, CR3, CR4, EFER and PAT. CR2 is not replicated but is loaded by VMRUN. The MTRRs are not replicated.

While nested paging is enabled, all (guest) references to the state of the paging registers by x86 code (`MOV to/from CR n` , etc.) read and write the guest copy of the registers; the VMM's versions of the registers are untouched and continue to control the second level translations from guest physical to system physical addresses. In contrast, when nested paging is disabled, the VMM's paging control registers are stored in the host state save area and the paging control registers from the guest VMCB are the only active versions of those registers.

15.24.3 Enabling Nested Paging

The VMRUN instruction enables nested paging when the NP_ENABLE bit in the VMCB is set to 1. The VMCB contains the hCR3 value for the page tables for the extra translation. The extra translation uses the same paging mode as the VMM used when it executed the most recent VMRUN.

Nested paging is automatically disabled by #VMEXIT.

Nested paging is allowed only if the host has paging enabled. CPUID function 8000_000A.EDX[0] indicates that nested paging is available. If VMRUN is executed with hCR0.PG cleared to zero and NP_ENABLE set to 1, VMRUN terminates with #VMEXIT(VMEXIT_INVALID).

15.24.4 Nested Paging and VMRUN/#VMEXIT

When VMRUN is executed with nested paging enabled (NP_ENABLE = 1), the paging registers are affected as follows:

- VMRUN saves the VMM's CR3 in the host save area.
- VMRUN loads the guest paging state from the guest VMCB into the guest registers (i.e., VMRUN loads CR3 with the VMCB CR3 field, etc.). The guest PAT register is loaded from G_PAT field in the VMCB.
- VMRUN loads nCR3, the version of CR3 to be used while the nested-paging guest is running, from the N_CR3 field in the VMCB. The other host paging-control bits (hCR4.PAE, etc.) remain the same as they were in the VMM at the time VMRUN was executed.

When VMRUN is executed with nested paging enabled (NP_ENABLE = 1), the following conditions are considered illegal state combinations, in addition to those mentioned in “Canonicalization and Consistency Checks” on page 373:

- Any MBZ bit of nCR3 is set.
- Any G_PAT.PA field has an unsupported type encoding or any reserved field in G_PAT has a non-zero value. (See Section 7.8.1, “PAT Register,” on page 193.)

When #VMEXIT occurs with nested paging enabled:

- #VMEXIT writes the guest paging state (gCR3, gCR0, etc.) back into the VMCB. nCR3 is not saved back into the VMCB.
- #VMEXIT need not reload any host paging state other than CR3 from the host save area, though an implementation is free to do so.

15.24.5 Nested Table Walk

When the guest is running with nested paging enabled, a TLB miss causes several nested table walks:

- Guest Page Tables—the gCR3 register specifies a guest physical address, as do the entries in the guest's page tables. These guest physical addresses must be translated to system physical addresses using the nested page tables. Nested page table level faults can occur on these accesses, including write faults due to setting of accessed and dirty bits in the nested page table.

- Final Guest-Physical Page—once a guest linear to guest physical mapping is known, guest permissions can be checked. If the guest page tables allow the access, the guest physical address is walked in the nested page tables to find the system physical address.

Table walks for guest page tables are always treated as user writes at the nested page table level. For this reason,

- the page must be writable by user at the nested page table level, or else a #VMEXIT(NPF) is raised, and
- the dirty and accessed bits are always set in the nested page table entries that were touched during nested page table walks for guest page table entries.

A table walk for the guest page itself is always treated as a user access at the nested page table level, but is treated as a data read, data write, or code read, depending on the guest access.

If the guest has paging disabled ($gCR0.PG = 0$), there are no guest page table entries to be translated in the nested page tables. In this case, the final guest-physical address is equal to the guest-linear address, and is still translated in the nested page tables.

15.24.6 Nested versus Guest Page Faults, Fault Ordering

In nested paging, page faults can be raised at either the guest or nested page table level. Nested walks proceed in the following order; faults are generated in the same order:

1. Walk the guest page table entries in the nested page table. Dirty/Accessed bits are set as needed in the nested page table. Any nested page table faults result in #VMEXIT(NPF).
2. As the guest page table walk proceeds from the top of the page table to the last entry, any not-present entries or reserved bits in the guest page table entries at each level of the guest walk cause #PF in the guest. Guest dirty and accessed bits are set as needed in the guest page tables during the walk. Steps 1 and 2 are repeated for each level of the guest page table that is traversed.
3. Once the guest physical address for the guest access has been determined, check the guest permissions; any fault at this point causes a #PF in the guest.
4. Perform the final translation from guest physical to system physical using the nested page table; any fault during this translation results in a #VMEXIT(NPF).

Nested page faults are entirely a function of the nested page table and VMM processor mode. Nested faults cause a #VMEXIT(NPF) to the VMM. The faulting guest physical address is saved in the VMCB's EXITINFO2 field; EXITINFO1 delivers an error code similar to a #PF error code:

- Bit 0 (P)—cleared to 0 if the nested page was not present, 1 otherwise
- Bit 1 (RW)—set to 1 if the nested page table level access was a write. Note that host table walks for guest page tables are always treated as data writes.
- Bit 2 (US)—always 1, since all guest accesses are treated as user accesses at the nested level
- Bit 3 (RSV)—set to 1 if reserved bits were set in the corresponding nested page table entry

- Bit 4 (ID)—set to 1 if the nested page table level access was a code read. Note that nested table walks for guest page tables are always treated as data writes, even if the access itself is a code read

Guest faults are entirely a function of the guest page tables and processor mode; they are delivered to the guest as normal #PF exceptions without any VMM intervention, unless the VMM is intercepting guest #PF exceptions.

15.24.7 Combining Nested and Guest Attributes

Any access to guest physical memory is subjected to a permission check by examining the mapping of the guest physical address in the nested page table.

A page is considered writable by the guest only if it is marked writable at both the guest and nested page table levels. Note that the guest's gCR0.WP affects only the interpretation of the guest page table entry; setting gCR0.WP cannot make a page writable at any CPL in the guest, if the page is marked read-only in the nested page table. The host hCR0.WP bit is ignored under nested paging.

A page is considered executable by the guest only if it is marked executable at both the guest and nested page table levels. If the EFER.NXE bit is cleared for the guest, all guest pages are executable at the guest level. Similarly, if the EFER.NXE bit is cleared for the host, all nested page table mappings are executable at the underlying nested level.

Some attributes are taken from the guest page tables and operating modes only. A page is considered global within the guest only if is marked global in the guest page tables; the nested page table entry and host hCR4.PGE are irrelevant. Global pages are only global within their ASID.

A page is considered user in the guest only if it is marked as user at the guest level. The page must be marked user in the nested page table to allow any guest access at all.

15.24.8 Combining Memory Types, MTRRs

The processor combines guest and nested page table memory types; registers that affect memory types include:

- The PCD/PWT/PAT_i bits in the nested and guest page table entries.
- The PCD/PWT bits in the nested CR3 and guest CR3 registers.
- The guest PAT type (obtained by appropriately indexing the gPAT register).
- The host PAT type (obtained by appropriately indexing the host's PAT register).
- The MTRRs (which are referenced based only on system physical address).
- gCR0.CD and hCR0.CD.

Note that there is no hardware support for guest MTRRs; the VMM can simulate their effect by altering the memory types in the nested page tables. Note that the MTRRs are only applied to system physical addresses.

The rules for combining memory types when constructing a guest TLB entry are:

- Nested and guest PAT types are combined according to Table 15-13 on page 412, producing a “combined PAT type”
- the combined PAT type is further combined with the MTRR type according to Table 15-14 on page 413, where the relevant MTRRs are determined by the system physical address.
- either gCR0.CD or hCR0.CD can disable caching

Memory Consistency Issues. Because the guest uses extra fields to determine the memory type, the VMM may use a different memory type to access a given piece of memory than does the guest. If one access is cacheable and the other is not, the VMM and guest could observe different memory images, which is undesirable. (MP systems are particularly sensitive to this problem when the VMM desires to migrate a virtual processor from one physical processor to another.)

To address this issue, the following mechanisms are provided:

- VMRUN and #VMEXIT flush the write combiners. This ensures that all writes to WC memory by the guest are visible to the host (or vice-versa) regardless of memory type. (It does not ensure that cacheable writes by one agent are properly observed by WC reads or writes by the other agent.)
- A new memory type WC+ is introduced. WC+ is an uncacheable memory type, and combines writes in write-combining buffers like WC. Unlike WC (but like the CD memory type), accesses to WC+ memory also snoop the caches on all processors (including self-snooping the caches of the processor issuing the request) to maintain coherency. This ensures that cacheable writes are observed by WC+ accesses.
- When combining nested and guest memory types that are incompatible with respect to caching, the WC+ memory type is used instead of WC (and Table 15-14 on page 413 ensures that the snooping behavior is retained regardless of the host MTRR settings). Refer to Table 15-13 on page 412 or details.

Table 15-13 shows how guest and host PAT types are combined into an effective PAT type. When interpreting this table, recall that the intent is for the VMM to use its PAT type to simulate guest MTRRs.

Table 15-13. Combining Guest and Host PAT Types

		Host PAT Type					
		UC	UC–	WC	WP	WT	WB
Guest PAT Type	UC	UC	UC	UC	UC	UC	UC
	UC–	UC	UC	WC	UC	UC	UC
	WC	WC	WC	WC	WC+	WC+	WC+
	WP	UC	UC	UC	WP	UC	WP
	WT	UC	UC	UC	UC	WT	WT
	WB	UC	UC	WC	WP	WT	WB

The existing AMD64 table that defines how PAT types are combined with the physical MTRRs is extended to handle CD and WC+ PAT types as shown in Table 15-14.

Table 15-14. Combining PAT and MTRR Types

		MTRR Type				
		UC	WC	WP	WT	WB
Effective PAT Type	UC	UC	CD	CD	CD	CD
	UC-	UC	WC	CD	CD	CD
	WC	WC	WC	WC	WC	WC
	WC+	WC	WC	WC+	WC+	WC+
	WP	UC	CD	WP	CD	WP
	WT	UC	CD	CD	WT	WT
	WB	UC	WC	WP	WT	WB

15.24.9 Page Splintering

When an address is mapped by guest and nested page table entries with different page sizes, the TLB entry that is created matches the size of the smaller page.

15.24.10 Legacy PAE Mode

The behavior of PAE mode in a nested-paging guest differs slightly from the behavior of (host-only) legacy PAE mode, in that the guest's four PDPEs are not loaded into the processor at the time CR3 is written. Instead, the PDPEs are accessed on demand as part of a table walk. This has the side-effect that illegal bit combinations in the PDPEs are not signaled at the time that CR3 is written, but instead when the faulty PDPE is accessed as part of a table walk.

This means that an operating system cannot rely on the behavior when the in-memory PDPEs are different than the in-processor copy.

15.24.11 A20 Masking

There is no provision for applying A20 masking to guest physical addresses; the VMM can emulate A20 masking by changing the nested page mappings accordingly.

15.24.12 Detecting Nested Paging Support

Nested Paging is an optional feature of SVM and is not available in all implementations of SVM-capable processors. The CPUID instruction should be used to detect nested paging support on a particular processor (see the *CPUID Specification*, order# 24581, for the details of processor feature identification and support).

15.25 Security

SVM provides additional hardware support that is designed to facilitate the construction of trusted software systems. While the security features described in this section are orthogonal to SVM's virtualization support (and are not required for processor virtualization), the two form building blocks for trusted systems.

SKINIT Instruction. The SKINIT instruction and associated system support (the Trusted Platform Module or TPM) are designed to allow for verifiable startup of trusted software (such as a VMM), based on secure hash comparison.

Security Exception. A security exception (#SX) is used to signal certain security-critical events.

15.26 Secure Startup with SKINIT

The SKINIT instruction is one of the keys to creating a “root of trust” starting with an initially untrusted operating mode. SKINIT reinitializes the processor to establish a secure execution environment for a software component called the secure loader (SL) and starts execution of the SL in a way that cannot be tampered with. SKINIT also copies the secure loader executable image to an external device, such as a Trusted Platform Module (TPM) for verification using unique bus transactions that preclude SKINIT operation from being emulated by software in a way that the TPM could not readily detect. (Detailed operation is described in Section 15.26.4.)

15.26.1 Secure Loader

A secure loader (SL) typically initializes SVM hardware mechanisms and related data structures, and initiates execution of a trusted piece of software such as a VMM or VMM (referred to as a Security Kernel, or SK, in this document), after first having validated the identity of that software.

One of the main features of SKINIT allows SVM protections to be reliably enabled after the system is already up and running in a non-trusted mode — there is no requirement to change the typical x86 platform boot process.

Exact details of the handoff from the SL to an SK are dependent on characteristics of the SL, SK and the initial untrusted operating environment. However, there are specific requirements for the SL image, as described in Section 15.26.2.

15.26.2 Secure Loader Image

The secure loader (SL) image contains all code and initialized data sections of a secure loader. This code and initial data are used to initialize and start a security kernel in a completely safe manner, including setting up DEV protection for memory allocated for use by SL and SK. The SL image is loaded into a region of memory called the secure loader block (SLB) and can be no larger than 64Kbyte (see “Secure Loader Block” on page 415). The SL image is defined to start at byte offset 0 in the SLB.

The first word (16 bits) of the SL image must specify the SL entry point as an unsigned offset into the SL image. The second word must contain the length of the image in bytes; the maximum length allowed is 65535 bytes. These two values are used by the SKINIT instruction. The layout of the rest of the image is determined by software conventions. The image typically includes a digital signature for validation purposes. The digital signature hash must include the entry point and length fields. SKINIT transfers the SL image to the TPM for validation prior to starting SL execution (see “SKINIT Operation” on page 417 for further details of this transfer). The SL image for which the hash is computed must be ready to execute without prior manipulation.

15.26.3 Secure Loader Block

The secure loader block is a 64Kbyte range of physical memory which may be located at any 64Kbyte-aligned address below 4Gbyte. The SL image must have been loaded into the SLB starting at offset 0 before executing SKINIT. The physical address of the SLB is provided as an input operand (in the EAX register) to SKINIT, which sets up special protection for the SLB against device accesses (i.e., the DEV need not be activated yet).

The SL must be written to execute initially in flat 32-bit protected mode with paging disabled. A base address can be derived from the value in EAX to access data areas within the SL image using base+displacement addressing, to make the SL code position-independent.

Memory between the end of the SL image and the end of the SLB may be used immediately upon entry by the SL as secure scratch space, such as for an initial stack, before DEV protections are set up for the rest of memory. The amount of space required for this will limit the maximum size of the SL image, and will depend on SL implementation. SKINIT sets the ESP register to the appropriate top-of-stack value (EAX + 10000h).

Figure 15-13 on page 416 illustrates the layout of the SLB, showing where EAX and ESP point after SKINIT execution. Labels in italics indicate suggested uses; other labels reflect required items.

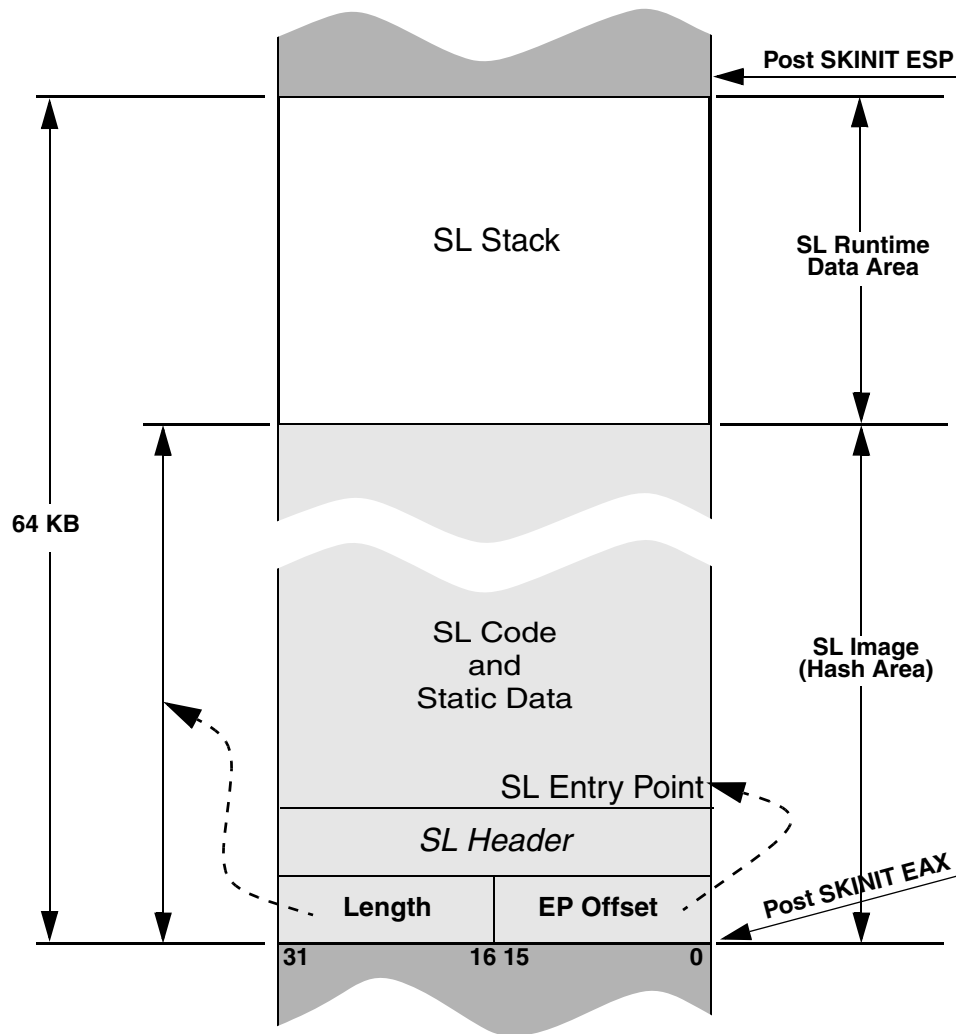

Figure 15-13. SLB Example Layout

15.26.4 Trusted Platform Module

The trusted platform module, or TPM, is an essential part of full trusted system initialization. This device is attached to an LPC link off the system I/O hub. It recognizes special SKINIT transactions, receives the SL image sent by SKINIT and verifies the signature. Based on the outcome, the device decides whether or not to cooperate with the SL or subsequent SK. The TPM typically contains sealed storage containing cryptographic keys and other high-security information that may be specific to the platform.

15.26.5 System Interface, Memory Controller and I/O Hub Logic

SKINIT uses special support logic in the processor's system interface unit, the internal controller and the I/O hub to which the TPM is attached. SKINIT uses special transactions that are unique to SKINIT, along with this support logic, designed to securely transmit the SL Image to the TPM for validation.

The use of this special protocol should allow the TPM to reliably detect true execution, as opposed to emulation, of a trusted Secure Loader, which in turn provides a reliable means for verifying the subsequent loading and startup of a trusted Security Kernel.

15.26.6 SKINIT Operation

The SKINIT instruction is intended to be used primarily in normal mode prior to the VMM taking control.

SKINIT takes the physical base address of the SLB as its only input operand in EAX, and performs the following steps:

1. Reinitialize processor state in the same manner as for the INIT signal, then enter flat 32-bit protected mode with paging off. The CS selector is set to 8h and CS is read only. The SS selector is set to 10h and SS is read/write and expand-up. The CS and SS bases are cleared to 0 and limits are set to 4G. DS, ES, FS and GS are left as 16-bit real mode segments and the SL must reload these with protected mode selectors having appropriate GDT entries before using them. Initialized data in the SLB may be referenced using the SS segment override prefix until DS is reloaded. The general purpose registers are cleared except for EAX, which points to the start of the secure loader, EDX, which contains model, family and stepping information, and ESP, which contains the initial stack pointer for the secure loader. Cache contents remain intact, as do the x87 and SSE control registers. Most MSRs also retain their values, except those which might compromise SVM protections. The EFER MSR, however, is cleared. The DPD, R_INIT and DIS_A20M flags in the VM_CR register are unconditionally set to 1.
2. Form the SLB base address by clearing bits 15–0 of EAX (EAX is updated), and enable the SL_DEV protection mechanism (see “Secure Initialization Support” on page 406) to protect the 64-Kbyte region of physical memory starting at the SLB base address from any device access.
3. In multiprocessor operation, perform an interprocessor handshake as described in Section 15.26.8 on page 418.
4. Read the SL image from memory and transmit it to the TPM in a manner that cannot be emulated by software.
5. Signal the TPM to complete the hash and verify the signature. If any failures have occurred along the way, the TPM will conclude that no valid SL was started.
6. Clear the Global Interrupt Flag. This disables all interrupts, including NMI, SMI and INIT and ensures that the subsequent code can execute atomically. If the processor enters the shutdown state (due to a triple fault for instance) while GIF is clear, it can only be restarted by means of a RESET.

7. Update the ESP register to point to the first byte beyond the end of the SLB (SLB base + 65536), so that the first item pushed onto the stack by the SL will be at the top of the SLB.
8. Add the unsigned 16-bit entry point offset value from the SLB to the SLB base address to form the SL entry point address, and jump to it.

The validation of the SL image by the TPM is a one-way transaction as far as SKINIT is concerned. It does not depend on any response from the TPM after transferring the SL image before jumping to the SL entry point, and initiates execution of the Secure Loader unconditionally. Because of the processor initialization performed, SKINIT does not honor instruction or data breakpoint traps, or trace traps due to EFLAGS.TF.

Pending interrupts. Device interrupts that may be pending prior to SKINIT execution due to EFLAGS.IF being clear, or that assert during the execution of SKINIT, will be held pending until software subsequently sets GIF to 1. Similarly, SMI, INIT and NMI interrupts that assert after the start of SKINIT execution will also be held pending until GIF is set to 1.

Debug Considerations. SKINIT automatically disables various implementation-specific hardware debug features. A debug version of the SL can reenable those features by clearing the VM_CR.DPD flag immediately upon entry.

15.26.7 SL Abort

If the SL determines that it cannot properly initialize a valid SK, it must cause GIF to be set to 1 and clear the VM_CR MSR to re-enable normal processor operation.

15.26.8 Secure Multiprocessor Initialization

The following standard APIC features are used for secure MP initialization:

- The concept of a single Bootstrap Processor (BSP) and multiple Application Processors (APs).
- The INIT interprocessor interrupt (IPI), which puts the target processors into a halted state which is responsive only to a subsequent Startup IPI.
- The Startup IPI causes target processors to begin execution at a location in memory that is specified by the Boot Processor and conveyed along with the Startup IPI. The operation of the processor in response to a Startup IPI is slightly modified to support secure initialization, as described below.

A Startup IPI normally causes an AP to start execution at a location provided by the IPI. To support secure MP startup, each AP responds to a startup IPI by additionally clearing its GIF and setting the DPD, R_INIT and DIS_A20M flags in the VM_CR register if, and only if, the BSP has indicated that it has executed an SKINIT. All other aspects of Startup IPI behavior remain unchanged.

Software Requirements for Secure MP initialization. The driver that starts the SL must execute on the BSP. Prior to executing the SKINIT instruction, the driver must save any processor-specific system register contents to memory for restoration after reinitialization of the APs. The driver should also put all APs in an idle state. The driver must first confirmed that all APs are idle and then it must issue an

INIT IPI to all APs and wait for its local APIC busy indication to clear. This places the APs into a halted state which is responsive only to a subsequent Startup IPI. APs will still respond to snoops for cache coherency. The driver may execute SKINIT at any time after this point. Depending on processor implementation, a fixed delay of no more than 1000 processor cycles may be necessary before executing SKINIT to ensure reliable sensing of APIC INIT state by the SKINIT.

AP Startup Sequence. While the SL starts executing on the BSP, the APs remain halted in APIC INIT state. Either the SL or the SK may issue the Startup IPI for the APs at whatever point is deemed appropriate. The Startup IPI conveys an 8-bit vector specified by the software that issues the IPI to the APs. This vector provides the upper 8 bits of a 20-bit physical address. Therefore, the AP startup code must reside in the lower 1Mbyte of physical memory—with the entry point at offset 0 on that particular page.

In response to the Startup IPI, the APs start executing at the specified location in 16-bit real mode. This AP startup code must set up protections on each processor as determined by the SL or SK. It must also set GIF to re-enable interrupts, and restore the pre-SKINIT system context (as directed by the SL or SK executing on the BSP), before resuming normal system operation.

The SL must guarantee the integrity of the AP startup sequence, for example by including the startup code in the hashed SL image and setting up DEV protection for it before copying it to the desired area. The AP startup code does not need to (and should not) execute SKINIT.

Pending interrupts. Device interrupts that may be pending on an AP prior to the APIC INIT IPI due to EFLAGS.IF being clear, or that assert any time after the processor has accepted the INIT IPI, will be held pending through the subsequent Startup IPI, and remain pending until software sets GIF to 1 on that AP. Similarly, SMI, INIT, and NMI interrupts that assert after the processor has accepted the INIT IPI will also be held pending until GIF is set to 1.

Aborting MP initialization. In the event that the SL or SK on the BSP decides to abort SVM system initialization for any reason, the following clean-up actions must be performed by SL code executing on each processor before returning control to the original operating environment:

- The BSP and all APs that responded to the Startup IPI must restore GIF and clear VM_CR on each processor for normal operation.
- For each processor that has a distinct memory controller associated with it, the SL_DEV_EN flag in the DEV control register must be cleared in order to restore normal device accessibility to the 64KB SL memory range.

Any secure context created by the SL that should not be exposed to untrusted code should be cleaned up as appropriate before these steps are taken.

15.27 Security Exception (#SX)

The Security Exception fault signals security-sensitive events that occur while executing the VMM, in the form of an exception so that the VMM may take appropriate action. (A VMM would typically intercept comparable sensitive events in the guest.) In the current implementation, the only use of the

#SX is to redirect external INITs into an exception so that the VMM may — among other possibilities — destroy sensitive information before re-issuing the INIT, this time without redirection. The INIT redirection is controlled by the VM_CR.R_INIT bit.

The #SX exception dispatches to vector 30, and behaves like other fault-class exceptions such as General Protection Fault (#GP). The #SX exception pushes an error code. The only error code currently defined is 1, and indicates redirection of INIT has occurred.

The #SX exception is a contributory fault.

15.28 SVM Related MSRs

SVM uses the following MSRs for various control purposes. These MSRs are available regardless of whether SVM is enabled in EFER.SVME. For details on implementation-specific features, see the AMD BIOS and Kernel Developer’s Guide for your processor implementation.

15.28.1 VM_CR MSR (C001_0114h)

The VM_CR MSR controls certain global aspects of SVM. The layout of the MSR is shown in Figure 15-14.



Figure 15-14. Layout of VM_CR MSR (C001_0114h)

The individual fields are as follows:

- DPD—Bit 0. If set, disables HDT and certain internal debug features.
- R_INIT—Bit 1. If set, non-intercepted INIT signals are converted into an #SX exception.
- DIS_A20M—Bit 2. If set, disables A20 masking.
- LOCK—Bit 3. When this bit is set, writes to LOCK and SVMDIS are silently ignored. When this bit is clear, VM_CR bits 3 and 4 can be written. Once set, LOCK can only be cleared using the SVM_KEY MSR (see Section 15.29, “SVM-Lock,” on page 422.) This bit is not affected by INIT or SKINIT.
- SVMDIS—Bit 4. When this bit is set, writes to EFER treat the SVME bit as MBZ. When this bit is clear, EFER.SVME can be written normally. This bit does not prevent CPUID from reporting that SVM is available. Setting SVMDIS while EFER.SVME is 1 generates a #GP fault, regardless of the current state of VM_CR.LOCK. This bit is not affected by SKINIT. It is cleared by INIT when LOCK is cleared to 0; otherwise, it is not affected.

15.28.2 IGNNE MSR (C001_0115h)

The read/write IGNNE MSR is used to set the state of the processor-internal IGNNE signal directly. This is only useful if IGNNE emulation has been enabled in the HW_CR MSR (and thus the external signal is being ignored). Bit 0 specifies the current value of IGNNE; all other bits are MBZ.

15.28.3 SMM_CTL MSR (C001_0116h)

The write-only SMM_CTL MSR provides software control over SMM signals.

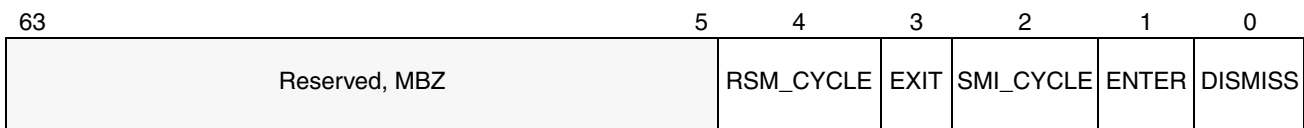

Figure 15-15. Layout of SMM_CTL MSR (C001_0116h)

Writing individual bits causes the following actions:

- DISMISS—Bit 0. Clear the processor-internal “SMI pending” flag.
- ENTER—Bit 1. Enter SMM: map the SMRAM memory areas, record whether NMI was currently blocked and block further NMI and SMI interrupts.
- SMI_CYCLE—Bit 2. Send SMI special cycle.
- EXIT—Bit 3. Exit SMM: unmap the SMRAM memory areas, restore the previous masking status of NMI and unconditionally reenables SMI.
- RSM_CYCLE—Bit 4. Send RSM special cycle.

Writes to the SMM_CTL MSR cause a #GP if the BIOS has locked the SMM control registers by setting HWCR[SMMLOCK].

Conceptually, the bits are processed in the order of ENTER, SMI_CYCLE, DISMISS, RSM_CYCLE, EXIT, though only the following bit combinations may be set together in a single write (for all other combinations of more than one bit, behavior is undefined):

- ENTER + SMI_CYCLE
- DISMISS + ENTER
- DISMISS + ENTER + SMI_CYCLE
- EXIT + RSM_CYCLE

The VMM must ensure that ENTER and EXIT operations are properly matched, and *not* nested, otherwise processor behavior is undefined. Also undefined are ENTER when the processor is already in SMM, and EXIT when the processor is not in SMM.

15.28.4 VM_HSAVE_PA MSR (C001_0117h)

The 64-bit read/write VM_SAVE_PA MSR holds the physical address of a block of memory where VMRUN saves host state, and from which #VMEXIT reloads host state. The VMM software is expected to set up this register before issuing the first VMRUN instruction. Software must not attempt to read or write the host save-state area directly.

Writing this MSR causes a #GP if:

- any of the low 12 bits of the address written are nonzero, or
- the address written is greater than or equal to the maximum supported physical address for this implementation.

15.29 SVM-Lock

The SVM-Lock feature allows software to prevent EFER.SVME from being set, either unconditionally or with a 64-bit key to re-enable SVM functionality.

Support for SVM-Lock is indicated by EDX bit 2 as returned by CPUID function 8000_000Ah. On processors that support the SVM-Lock feature, SKINIT and STGI can be executed even if EFER.SVME=0. See descriptions of LOCK and SVMDIS bits in Section 15.28.1, “VM_CR MSR (C001_0114h),” on page 420. When the SVM-Lock feature is not available, hypervisors can use the read-only VM_CR.SVMDIS bit to detect SVM (see Section 15.4, “Enabling SVM,” on page 369).

15.29.1 SVM_KEY MSR (C001_0118h)

The write-only SVM_KEY MSR is used to create a password-protected mechanism to clear VM_CR.LOCK.

When VM_CR.LOCK is zero, writes to SVM_KEY MSR set the 64-bit SVM Key value.

When VM_CR.LOCK is one, writes to SVM_KEY MSR compare the written value to the SVM Key value; if the values match and are non-zero, the VM_CR.LOCK bit is cleared. If the values mismatch or the SVM Key value is zero, the write to SVM_KEY is ignored, and VM_CR.LOCK is unmodified. Software should read VM_CR.LOCK after writing SVM_KEY to determine whether the unlock succeeded.

If SVM Key is zero when VM_CR.LOCK is one, VM_CR.LOCK can only be cleared by a processor reset.

To preserve the security of the SVM key, reading the SVM_KEY MSR always returns zero.

15.30 SMM-Lock

The SMM-Lock feature allows software to prevent System Management Interrupts (SMI) from being intercepted in SVM. The SmmLock bit is located in the HWCR MSR register.

15.30.1 SmmLock Bit — HWCR[0]

The SmmLock bit (bit 0) is located in the HWCR MSR (C001_0015h). When SmmLock is clear, it can be set to one. Once set, the bit cannot be cleared by software and writes to it are ignored. SmmLock can only be cleared using the SMM_KEY MSR (see Section 15.30.2), or by a processor reset. This bit is not affected by INIT or SKINIT. When SmmLock is set, other SMM configuration registers cannot be written. See the model-specific BKDG for details. For complete information on the HWCR register, see the appropriate BIOS and kernel developer's guide for your processor.

15.30.2 SMM_KEY MSR (C001_0119h)

The write-only SMM_KEY MSR is used to create a password-protected mechanism to clear SmmLock.

When SmmLock is zero, writes to SMM_KEY MSR set the 64-bit SMM Key value.

When SmmLock is one, writes to SMM_KEY MSR compare the written value to the SMM Key value; if the values match and are non-zero, the SmmLock bit is cleared. If the values mismatch or the SMM Key value is zero, the write to SMM_KEY is ignored, and SmmLock is unmodified. Software should read SmmLock after writing SMM_KEY to determine whether the unlock succeeded.

If SMM_Key MSR is equal to zero when SmmLock is one, SmmLock can only be cleared by a processor reset.

To preserve the security of the SMM key, reading SMM_KEY MSR always returns zero.

16 Advanced Programmable Interrupt Controller (APIC)

The Advanced Programmable Interrupt Controller (APIC) provides interrupt support on AMD64 architecture processors. The local APIC accepts interrupts from the system and delivers them to the local CPU core interrupt handler.

Support for an enabled APIC feature is indicated by EDX bit 9 as returned by CPUID function 0000_0001h.

The APIC block diagram is provided in Figure 16-1.

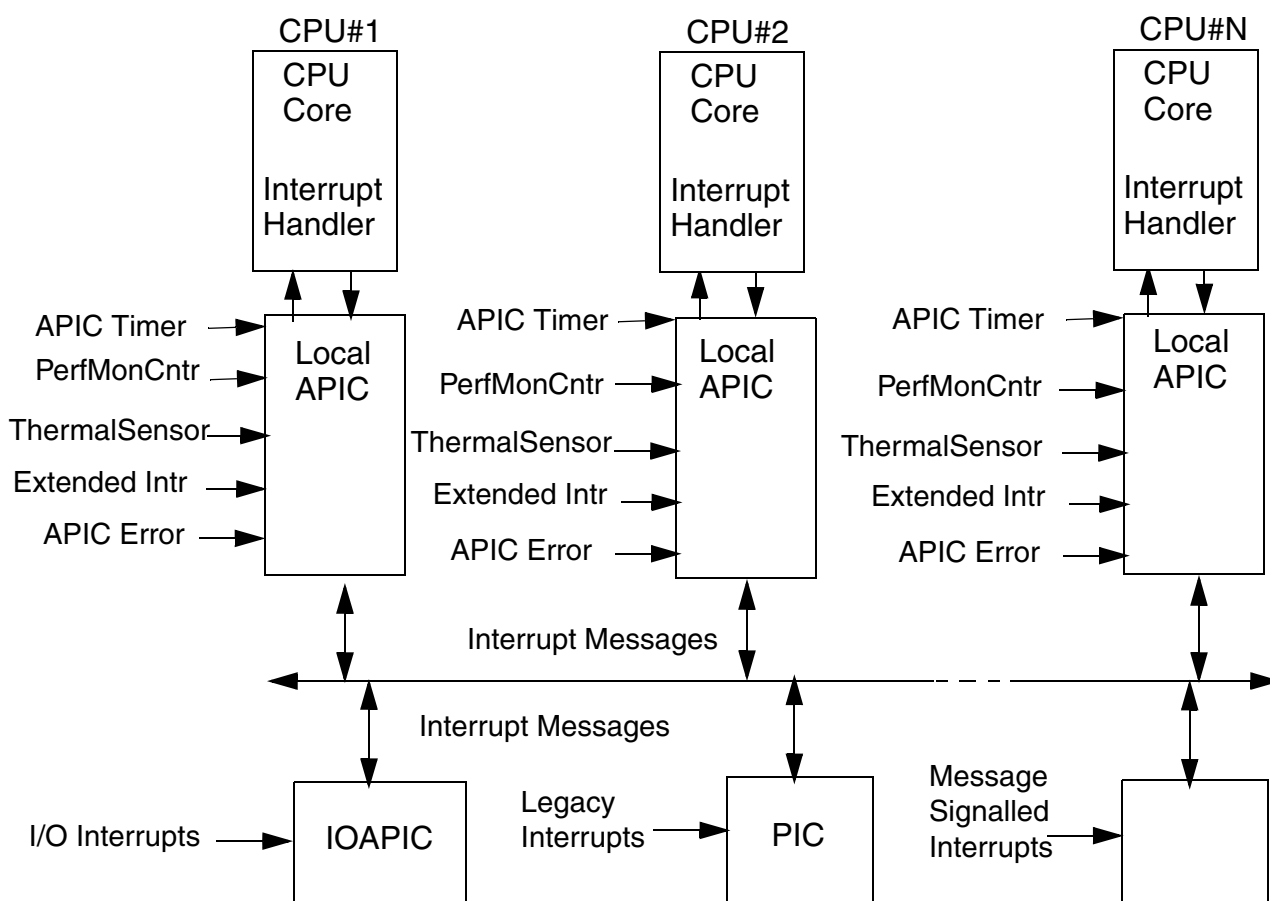

Figure 16-1. Block Diagram of a Typical APIC Implementation

16.1 Sources of Interrupts to the Local APIC

Each CPU core has an associated local APIC which receives interrupts from the following sources:

- I/O interrupts from the IOAPIC interrupt controller (including LINT0 and LINT1)
- Legacy interrupts (INTR and NMI) from the legacy interrupt controller
- Message Signalled Interrupts
- Interprocessor Interrupts (IPIs) from other local APICs. Interprocessor Interrupts are used to send interrupts or to execute system wide functions between CPU cores in the system, including the originating CPU core (self-interrupt).
- Locally generated interrupts within the local APIC. The local APIC receives local interrupts from the APIC timer, Performance Monitor Counters, thermal sensors, APIC errors and extended interrupts from implementation specific sources.

The sources of interrupts for the local APIC are provided in Table 16-1.

Table 16-1. Interrupt Sources for Local APIC

Source	Description	Message Type to Local APIC
I/O interrupts	System interrupts from I/O devices or system hardware received through the I/O APIC and sent to the local APIC as interrupt messages. They may be edge-triggered or level-sensitive.	Fixed, Lowest Priority, SMI, NMI, INIT, Restart, External interrupt, LINT0, LINT1
Legacy Interrupts	Legacy interrupts (INT and NMI) from the PIC and sent to the local APIC as interrupt messages.	NMI, INT
Interprocessor (IPI)	Interprocessor interrupts. Used for interrupt forwarding, system-wide functions, or software self-interrupts.	Fixed, lowest priority, SMI, read request, NMI, INIT, Restart, External interrupt
APIC Timer	Local interrupt from the programmed APIC timer reaches zero, under control of TIMER_LVT.	Fixed
Performance Monitor Counter	Local interrupt from the performance monitoring counter when it overflows, under control of PERF_CNT_LVT.	Fixed, SMI, or NMI
Thermal Sensor	Local interrupt from internal thermal sensors when it has tripped, under control of THERMAL_LVT.	Fixed, SMI, or NMI
Extended Interrupt[3:0]	Local Interrupts from programmable internal CPU core sources, under the control of the EXTENDED_INTERRUPT[3:0]_LVT.	Fixed, SMI, NMI, or External interrupt
APIC Internal Error	Local interrupt when an error is detected within the local APIC, under control of ERROR_LVT.	Fixed, SMI, or NMI

16.2 Interrupt Control

I/O, legacy and interprocessor interrupts are sent via interrupt messages. The interrupt messages contain the following information:

- Destination address of the local APIC.
- VECTOR[7:0] indicating interrupt priority of up to 256 interrupt vectors. This information is captured in the IRR register for Fixed and Lowest Priority interrupt message types.
- Trigger Mode indicating edge triggered or level-sensitive (which requires an EOI response to the source).
- Message Type[3:0] indicating the type of interrupt to be presented to the local APIC. For Fixed and Lowest Priority message types, the interrupt is processed through the target local APIC. For all other message types, the interrupt is sent directly to the destination CPU core. There is a 5-line interrupt interface to the CPU core for INTR, SMI, NMI, INIT and STARTUP interrupts. For locally-generated interrupts, control is provided by local vector tables or LVTs. Separate LVTs are provided for each interrupt source, allowing for unique entry point for each source. The LVT contains the VECTOR[7:0], trigger mode and message type as well as other fields associated with the specific interrupt. The message type may be Fixed, SMI, NMI, or External interrupt. A Mask bit is also provided to mask the interrupt.

16.3 Local APIC

16.3.1 Local APIC Enable

The local APIC is controlled by the APIC enable bit (AE) in the APIC Base Address Register (MSR 0000 001Bh). See Figure 16-2 on page 428.

When AE is set to 1, the local APIC is enabled and all interrupt types are accepted. When AE is cleared to 0, the local APIC is disabled, including all local vector table interrupts.

Software can disable the local APIC, using the APIC_SW_EN bit in the Spurious Interrupt Vector Register (APIC_F0). When this bit is cleared to zero, the local APIC is temporarily disabled:

- SMI, NMI, INIT, Startup, Remote Read, and LINT interrupts may be accepted.
- Pending interrupts in the ISR and IRR are held.
- Further fixed, lowest-priority, and ExtInt interrupts are not accepted.
- All LVT entry mask bits are set and cannot be cleared.

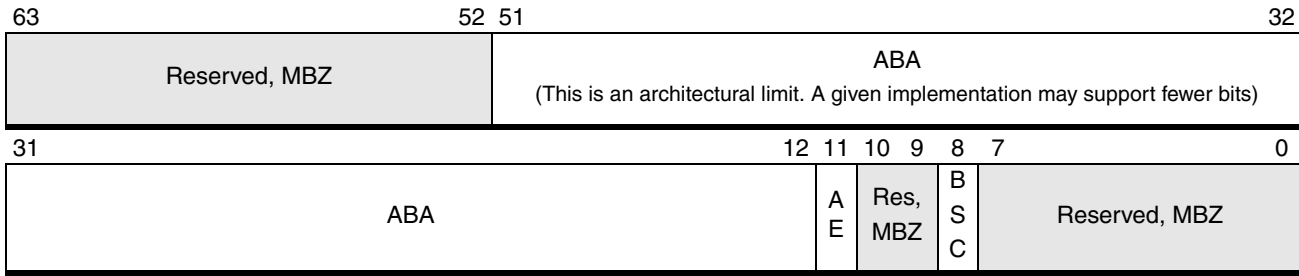

Bits	Mnemonic	Description	R/W
63-52	Reserved	Reserved, Must be Zero	
51-12	ABA	APIC Base Address	R/W
11	AE	APIC Enable	R/W
10-9	Reserved	Reserved, Must be Zero	
8	BSC	Boot Strap CPU Core	RO
7-0	Reserved	Reserved, Must be Zero	

Figure 16-2. APIC Base Address Register

The fields within the APIC Base Address register are as follows:

- *Boot Strap CPU Core (BSC)*—Bit 8. The BSC bit indicates that this CPU core is the boot core of the BSP. Each CPU core that is not the boot core of the boot processor is an AP (Application Processor).
- *APIC Enable (AE)*—Bit 11. This is the APIC enable bit. The local APIC is enabled and all interruption types are accepted when AE is set to 1. Clearing AE to 0 disables the local APIC, and no local vector table interrupts are supported.
- *APIC Base Address (ABA)*—Bits 51-12. Specifies the base physical address for the APIC register set. The address is extended by 12 bits at the least significant end to form a base address that is reset to a value of 0 FEE0 0000h.

16.3.2 APIC Registers

The local APIC is made up of APIC registers (see Table 16-2) and associated hardware used to control delivery of interrupts to the associated CPU core interrupt handler. All APIC registers are memory-mapped into the 4-Kbyte APIC register space, and are accessed with memory reads and writes. The memory address is indicated as:

$$\text{APIC Register address} = \text{APIC Base Address} + \text{Offset}$$

where the APIC Base Address must point to an uncacheable memory region, and is located in APIC Base Address Register, MSR 0000_001Bh. See Figure 16-2.

Registers are aligned on 128-bit boundaries, and are normally 32 bits in length. Doubleword registers should be accessed with doubleword loads and stores aligned on a 128-bit boundary.

The state of the APIC registers after reset is provided in Table 16-2.

Table 16-2. APIC Registers

Offset	Name	Reset
20h	APIC ID Register	??000000h
30h	APIC Version Register	80??0010h
80h	Task Priority Register (TPR)	00000000h
90h	Arbitration Priority Register (APR)	00000000h
A0h	Processor Priority Register (PPR)	00000000h
B0h	End of Interrupt Register (EOI)	–
C0h	Remote Read Register	00000000h
D0h	Logical Destination Register (LDR)	00000000h
E0h	Destination Format Register (DFR)	FFFFFFFF
F0h	Spurious Interrupt Vector Register	000000FFh
100-170h	In-Service Register (ISR)	00000000h
180-1F0h	Trigger Mode Register (TMR)	00000000h
200-270h	Interrupt Request Register (IRR)	00000000h
280h	Error Status Register (ESR)	00000000h
300h	Interrupt Command Register Low (bits 31:0)	00000000h
310h	Interrupt Command Register High (bits 63:32)	00000000h
320h	Timer Local Vector Table Entry	00010000h
330h	Thermal Local Vector Table Entry	00010000h
340h	Performance Counter Local Vector Table Entry	00010000h
350h	Local Interrupt 0 Vector Table Entry	00010000h
360h	Local Interrupt 1 Vector Table Entry	00010000h
370h	Error Vector Table Entry	00010000h
380h	Timer Initial Count Register	00000000h
390h	Timer Current Count Register	00000000h
3E0h	Timer Divide Configuration Register	00000000h
400h	Extended APIC Feature Register	00040007h
410h	Extended APIC Control Register	00000000h
420h	Specific End of Interrupt Register (SEOI)	–
480-4F0h	Interrupt Enable Registers (IER)	FFFFFFFFh
500-530h	Extended Interrupt [3:0] Local Vector Table Registers	00000000h

16.3.3 Local APIC ID

Unique local APIC IDs are assigned to each CPU core in the system. The value is determined by hardware, based on the number of CPU cores on the processor and the node ID of the processor.

The APIC ID is located in the APIC ID register at APIC offset 20h. See Figure 16-3. It is model dependent, whether software can modify the APIC ID Register. The initial value of the APIC ID (after a reset) is the value returned in CUID function 0000_0001h_EBX[31:24].

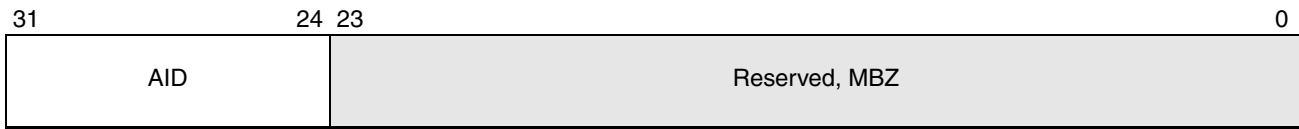

Bits	Mnemonic	Description	R/W
31-24	AID	APIC ID	R/W
23-0	Reserved	Reserved, Must be Zero	

Figure 16-3. APIC ID Register (APIC Offset 20h)

- *APIC ID (AID)*—Bits 31-24. The APIC ID field contains the unique APIC ID value assigned to this specific CPU core. A given implementation may use some bits to represent the CPU core and other bits represent the processor.

16.3.4 APIC Version Register

A version register is provided to allow software to identify which APIC version is used. Bits 7:0 of the APIC Version Register indicate the version number of the APIC implementation.

The number of entries in the local vector table are specified in bits 23:16 of the register as the maximum number minus one.

Bit 31 indicates the presence of extended APIC registers which have an offset starting at 400h.

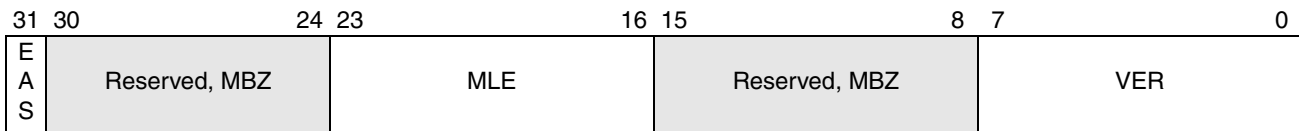

Bits	Mnemonic	Description	R/W
31	EAS	Extended APIC Register Space Present	RO
30-24	Reserved	Reserved, Must be Zero	
23-16	MLE	Max LVT Entries	RO
15-8	Reserved	Reserved, Must be Zero	
7-0	VER	Version	RO

Figure 16-4. APIC Version Register (APIC Offset 30h)

The fields within the APIC Version register are as follows:

- *Version (VER)*—Bits 7-0. The VER field indicates the version number of the APIC implementation. The local APIC implementation is identified with a value=1Xh (20h-FFh are reserved).
- *Max LVT Entries (MLE)*—Bits 23-16. The MLE field specifies the number of entries in the local vector table minus one.
- *Extended APIC Register Space Present (EAS)*—Bit 31. The EAS bit when set to 1 indicates the presence of an extended APIC register space, starting at offset 400h.

16.3.5 Extended APIC Control Register

This bit enables writes to the interrupt enable registers.

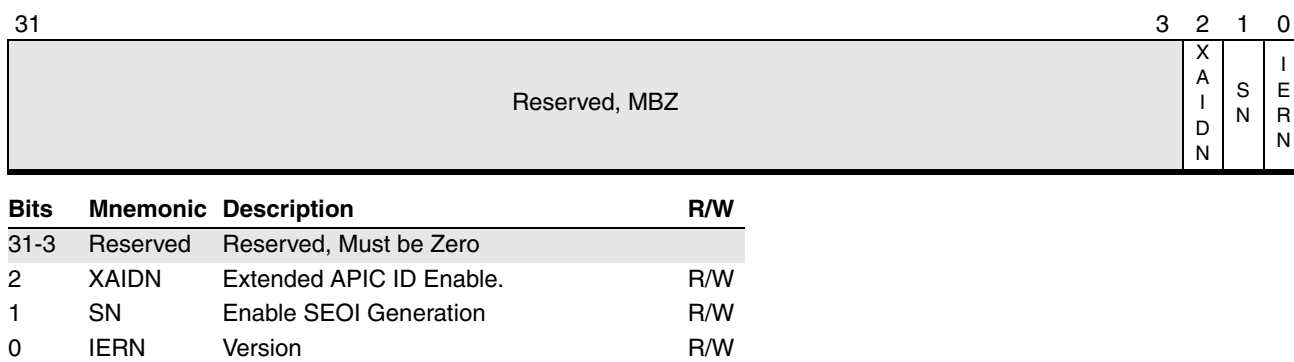

Figure 16-5. Extended APIC Control Register (APIC Offset 410h)

- Extended APIC ID Enable (XAIDN)—Bit 2. Setting XAIDN to 1 enables the upper four bits of the APIC ID field described in “APIC ID Register (APIC Offset 20h)” on page 430. Clearing this bit, specifies a 4-bit APIC ID using only the lower four bits of the APIC ID field of the APIC ID register.
- Enable SEOI Generation (SN)—Bit 1. Read-write. This bit enables Specific End of Interrupt (SEOI) generation when a write to the specific end of interrupt register is received.
- Enable Interrupt Enable Registers (IERN)—Bit 0. This bit enables writes to the interrupt enable registers.

16.4 Local Interrupts

The local APIC handles the following local interrupts:

- APIC Timer
- Local Interrupt 0 (LINT0)
- Local Interrupt 1 (LINT1)

- Performance Monitor Counters
- Thermal Sensors
- APIC internal error
- Extended (Implementation dependent)

A separate entry in the local vector table is provided for each interrupt to allow software to specify:

- Whether the interrupt is masked or not.
- The delivery status of the interrupt.
- The message type.
- The unique address vector.
- For LINT0 and LINT1 interrupts, the trigger mode, remote IRR, and input pin polarity.
- For the APIC timer interrupt, the timer mode.

The general format of a Local Vector Table Register is shown in Figure 16-6.

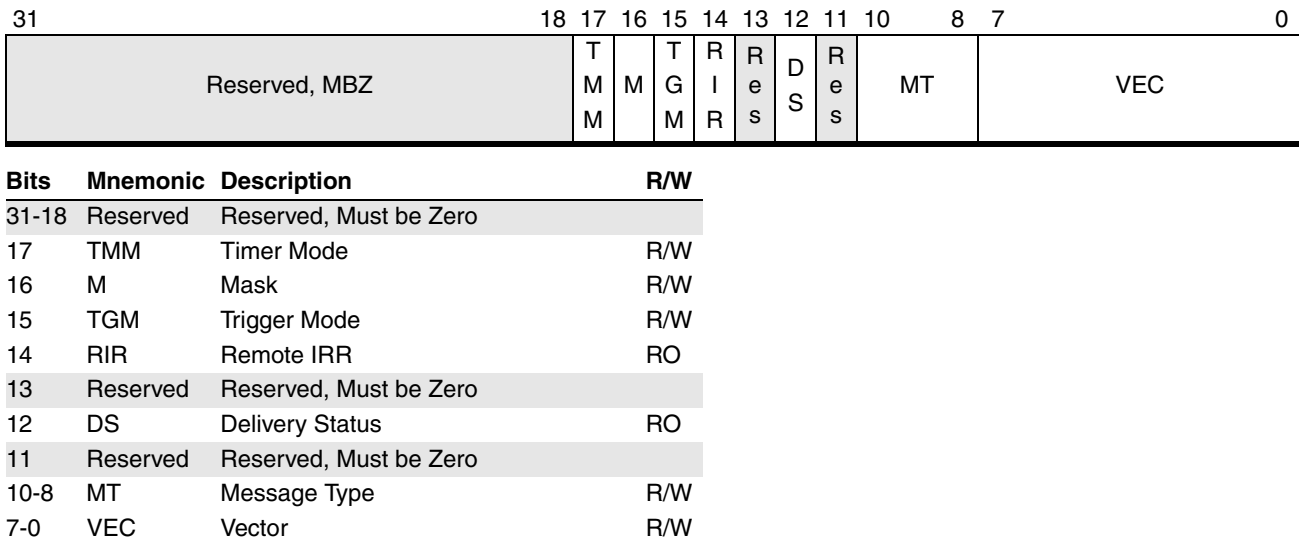

Figure 16-6. General Local Vector Table Register Format

The fields within the General Local Vector Table register are as follows:

- *Vector (VEC)*—Bits 7-0. The VEC field contains the vector that is sent for this interrupt source when the message type is fixed. It is ignored when the message type is NMI and is set to 00h when the message type is SMI. Valid values for the vector field are from 16 to 255. A value of 0 to 15 when the message type is fixed results in an illegal vector APIC error.

- *Message Type (MT)*—Bits 10-8. The MT field specifies the delivery mode sent to the CPU core interrupt handler. The legal values are:
 - 000b = Fixed - The vector field specifies the interrupt delivered.
 - 010b = SMI - An SMI interrupt is delivered. In this case, the vector field should be set to 00h.
 - 100b = NMI - A NMI interrupt is delivered with the vector field being ignored.
 - 111b = External interrupt is delivered.
- *Delivery Status (DS)*—Bit 12. The DS bit indicates the interrupt delivery status. The DS bit is set to 1 when the interrupt is pending at the CPU core interrupt handler. After a successful delivery of the interrupt, the associated bit in the IRR is set and this bit is cleared to zero. See Section 16.6.2, “Lowest Priority Messages and Arbitration,” on page 443 for details. The bit is cleared to 0 when the interrupt is idle.
- *Remote IRR (RIR)*—Bit 14. The RIR bit is set to 1 when the local APIC accepts an LINT0 or LINT1 interrupt with the trigger mode=1 (level sensitive). The bit is cleared to 0 when the interrupt completes, as indicated when an EOI is received.
- *Trigger Mode (TGM)*—Bit 15. Specifies how interrupts to the local APIC are triggered. The TGM bit is set to 1 when the interrupt is level-sensitive. It is cleared to 0 when the interrupt is edge-triggered. When the message type is SMI or NMI, the trigger mode is edge triggered.
- *Mask (M)*—Bit 16. When the M bit is set to 1, reception of the interrupt is disabled. When the M bit is cleared to 0, reception of the interrupt is enabled. For example, the mask bit is set in the Performance Monitor Counter LVT Register by hardware during a performance monitor counter interrupt and stays set until software resets it.
- *Timer Mode (TMM)*—Bit 17. Specifies the timer mode for the APIC Timer interrupt. The TMM bit set to 1 indicates periodic timer interrupts. The TMM bit cleared to 0 indicates one-shot operation.

16.4.1 APIC Timer Interrupt

The APIC timer is a programmable 32-bit counter used by software to time operations or events. The timer can operate in two modes, periodic and one-shot, under the control of bit 17 (Timer Mode) in APIC Timer Local Vector Table Register (see Figure 16-7). In one-shot mode, the APIC timer is set to a programmable initial value and decrements at a programmable clock rate. When the timer value reaches zero, an APIC timer interrupt is generated under the control of bit 16 (Mask) in the APIC Timer Local Vector Table Register. In periodic mode, the APIC timer is initialized again when it reaches zero, and it starts to decrement again. Another APIC timer interrupt is generated when the timer value reaches zero.

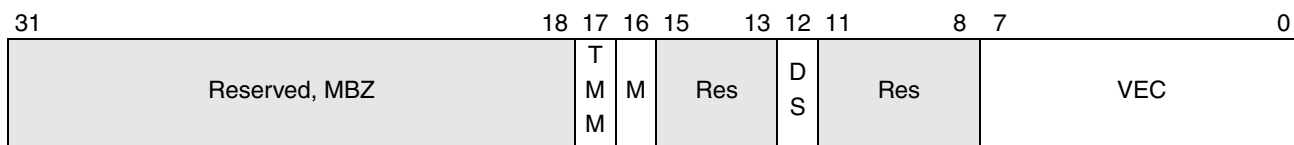

Figure 16-7. APIC Timer Local Vector Table Register (APIC Offset 320h)

Three APIC registers are defined for the APIC timer function:

- Current Count Register (CCR) is the actual APIC timer. It is initialized to a start count loaded from the ICR and then decrements. The APIC timer interrupt is generated when the CCR value reaches zero. The counting rate is controlled by the DCR. See Figure 16-8.
- Initial Count Register (ICR) contains the start count value for the APIC timer. See Table 16-9.
- Divide Configuration Register (DCR) controls the counting rate of the APIC timer by dividing the CPU core clock by a programmable amount. See Figure 16-10. Refer to the BIOS and kernel developer’s guide for the specific implementation of the base clock rate.

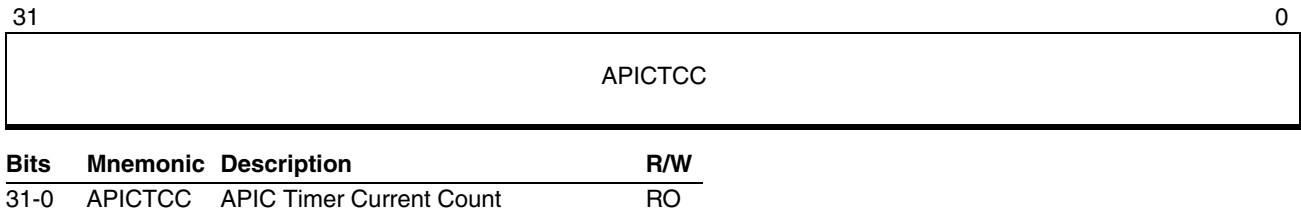

Figure 16-8. Timer Current Count Register (APIC Offset 390h)

- *APIC Timer Current Count (APICTCC)*—Bits 31-0. The APICTCC field contains the current value of the APIC timer.

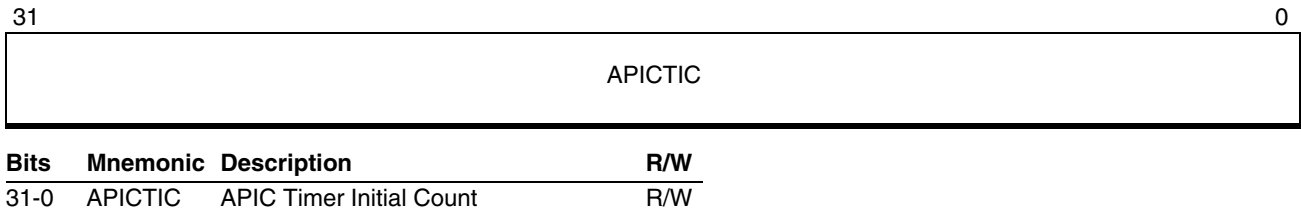

Figure 16-9. Timer Initial Count Register (APIC Offset 380h)

- *APIC Timer Initial Count (APICTIC)*—Bits 31-0. The APICTIC field contains the value that is loaded into the APIC Timer Current Count Register when the APIC timer is initialized.

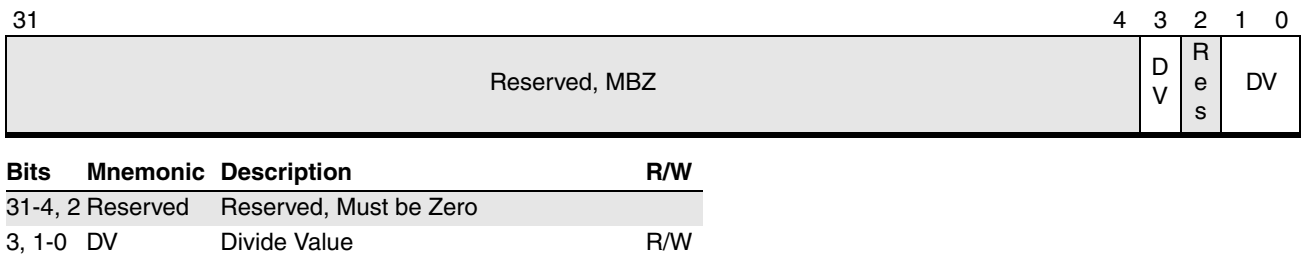

Figure 16-10. Divide Configuration Register (APIC Offset 3E0h)

- *Divide Value (DV)*—Bits 3, and 1-0. The DV field specifies the value of the CPU core clock divisor. Table 16-3 lists the allowable values.

Table 16-3. Divide Values

Bits 3, 1-0	Resulting Timer Divide
000b	Divide by 2
001b	Divide by 4
010b	Divide by 8
011b	Divide by 16
100b	Divide by 32
101b	Divide by 64
110b	Divide by 128
111b	Divide by 1

16.4.2 Local Interrupts LINT0 and LINT1

When the target local APIC receives an interrupt message from an IOAPIC with the LINT0 or LINT1 message type, the appropriate local interrupt is generated under the control of bit 16 (Mask) in the APIC LINT0 or LINT1 Local Vector Table Register. See Figure 16-11.

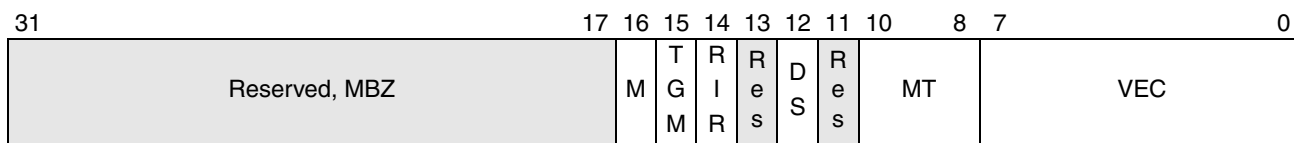

Figure 16-11. Local Interrupt 0/1 (LINT0/1) Local Vector Table Register (APIC Offset 350h/360h)

In addition to the normal LVT control bits (mask, delivery status and vector offset), the LINT0/LINT1 interrupts provide the following controls:

- *Trigger Mode* - indicates whether the interrupt pin is edge triggered or level sensitive when the message type is fixed.
- *Remote IRR* - When the trigger mode indicates level, this flag is set when the local APIC accepts the interrupt, and is reset when the local APIC receives an EOI. When the flag is set, no additional local interrupt requests are sent to the local APIC, and they remain pending.

16.4.3 Performance Monitor Counter Interrupts

When a performance monitor counter overflows, an APIC interrupt is generated under the control of bit 16 (Mask) in the APIC Performance Monitor Counter Local Vector Table Register. See Figure 16-12 on page 436.

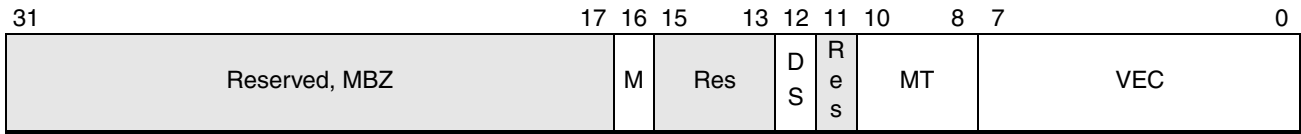

Figure 16-12. Performance Monitor Counter Local Vector Table Register (APIC Offset 340h)

16.4.4 Thermal Sensor Interrupts

When a thermal event occurs, an APIC interrupt is generated under the control of bit 16 (Mask) in the APIC Thermal Sensor Local Vector Table Register. See Figure 16-13. Refer to the BIOS and kernel developer’s guide for the specific implementation. This interrupt may not be supported in all implementations.

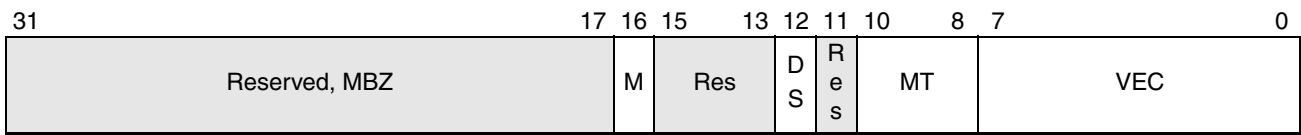

Figure 16-13. Thermal Sensor Local Vector Table Register (APIC Offset 330h)

16.4.5 Extended Interrupts

The local interrupts are extended to include more LVT registers, to allow additional interrupt sources. The additional sources are model dependent and can include:

- Counter overflow from the Machine Check Miscellaneous Threshold Register. See “Machine-Check Miscellaneous-Error Information Registers (MCi_MISCj)” on page 264 for details.
- ECC Error Count Threshold in memory system.
- Instruction Sampling.

The LVT register used for each interrupt source is specified by the control register associated with the source.

The Extended LVT Count field (bits 23:16) of the Extended APIC Feature Register specifies the number of extended LVT registers. Currently there are four additional LVT registers defined, Extended Interrupt [3:0], Local Vector Table Register, located at APIC [530:500]. (See section Section 16.7.1, “Extended APIC Feature Register,” on page 449 and Figure 16-28 on page 449.)

16.4.6 APIC Error Interrupts

Errors that are detected while handling interrupts cause an APIC error interrupt to be generated under the control of bit 16 (Mask) in the APIC Error Local Vector Table Register. See Figure 16-14 on page 437.

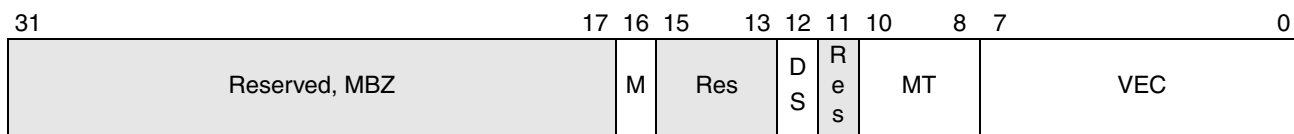
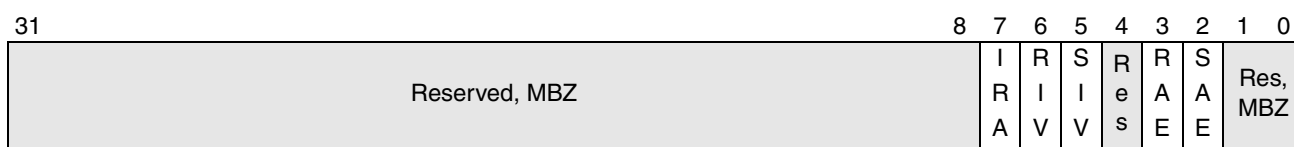

Figure 16-14. APIC Error Local Vector Table Register (APIC Offset 370h)

The error information is recorded in the APIC Error Status Registers. The APIC Error Status Register is a read-write register. Writes to the register cause the internal error state to be recorded in the register, clearing the original error. See Figure 16-15.



Bits	Mnemonic	Description	R/W
31-8		Reserved, Must be Zero	
7	IRA	Illegal Register Address	R/W
6	RIV	Received Illegal Vector	R/W
5	SIV	Sent Illegal Vector	R/W
4		Reserved, Must be Zero	
3	RAE	Receive Accept Error	R/W
2	SAE	Sent Accept Error	R/W
1-0		Reserved, Must be Zero	

Figure 16-15. APIC Error Status Register (APIC Offset 280h)

The fields within the APIC Error Status register are as follows:

- *Sent Accept Error (SAE)*—Bit 2. The SAE bit when set to 1 indicates that a message sent by the local APIC was not accepted by any other APIC.
- *Receive Accept Error (RAE)*—Bit 3. The RAE bit when set to 1 indicates that a message received by the local APIC was not accepted by this or any other APIC
- *Sent Illegal Vector (SIV)*—Bit 5. The SIV bit when set to 1 indicates that the local APIC attempted to send a message with an illegal vector value.
- *Receive Illegal Vector (RIV)*—Bit 6. The RIV bit when set to 1 indicates that the local APIC has received a message with an illegal vector value.
- *Illegal Register Address (IRA)*—Bit 7. The IRA bit when set to 1 indicates that an access to an unimplemented register location within the local APIC register range (APIC Base Address + 4 Kbytes) was attempted.

16.4.7 Spurious Interrupts

A timing issue exists between software and hardware that, though rare, results in spurious interrupts. In the event that the task priority is set to or above the level of the interrupt to be serviced while the interrupt is being acknowledged, the local APIC delivers a spurious interrupt to the CPU core instead, with the vector number specified by the Vector field of the Spurious Interrupt Register. The ISR is unaffected by the spurious interrupt, so the interrupt handler completes without sending an EOI back to the issuing local APIC.

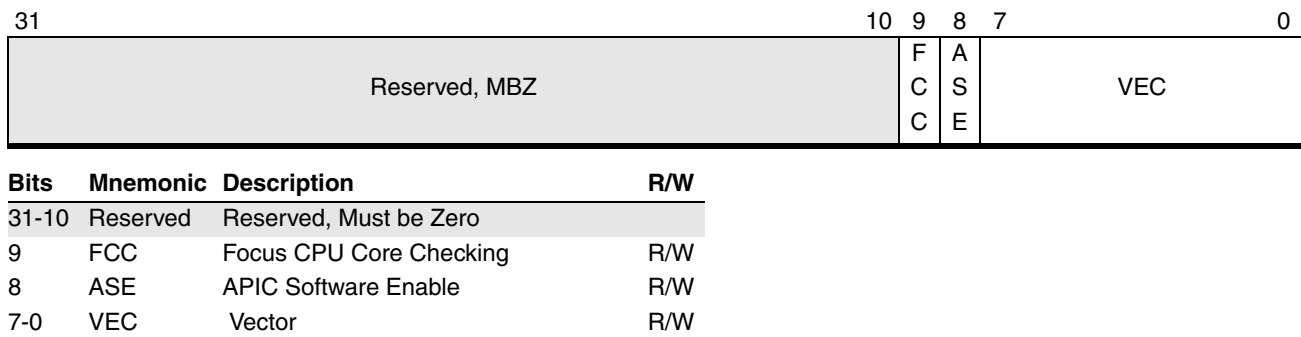

Figure 16-16. Spurious Interrupt Register (APIC Offset F0h)

The fields within the Spurious Interrupt register are as follows:

- *Vector (VEC)*—Bits 7-0. The VEC field contains the vector that is sent to the CPU core in the event of a spurious interrupt.
- *APIC Software Enable (ASE)*—Bit 8. The ASE bit when set to 0 disables the local APIC temporarily. When the local APIC is disabled, SMI, NMI, INIT, Startup, Remote Read, and LINT interrupts may be accepted; pending interrupts in the ISR and IRR are held, but further fixed, lowest-priority, and ExtInt interrupts are not accepted. All LVT entry mask bits are set and cannot be cleared. Setting the ASE bit to 1, enables the local APIC.
- *Focus CPU Core Checking (FCC)*—Bit 9. The FCC bit when set to 1 disables focus CPU core checking when the lowest-priority message type is used. A CPU core is the focus of an interrupt if it is already servicing that interrupt (ISR=1) or if it has a pending request for that interrupt (IRR=1). Clearing the FCC bit to 0 disables focus CPU core checking.

16.5 Interprocessor Interrupts (IPI)

A local APIC can send interrupts to other local APICs (or itself) using software-initiated Interprocessor Interrupts (IPIs) using the Interrupt Command Register (ICR). Writing into the low order doubleword of the ICR causes the IPI to be sent.

The ICR can issue the following types of interrupt messages:

- basic interrupt message to another local APIC, including forwarding an interrupt that was received but not serviced
- basic interrupt message to the same local APIC (self-interrupt)
- system management interrupt (SMI)
- remote read message to another local APIC to read one of its APIC registers.
- non-maskable interrupt (NMI) delivered to another local APIC
- initialization message (INIT) to all local APICs to be reset to their initialization state and await a startup message.
- startup message (SIPI) to the target local APICs, pointing to a start-up routine.

The format of the Interrupt Command Register is shown in Figure 16-17.

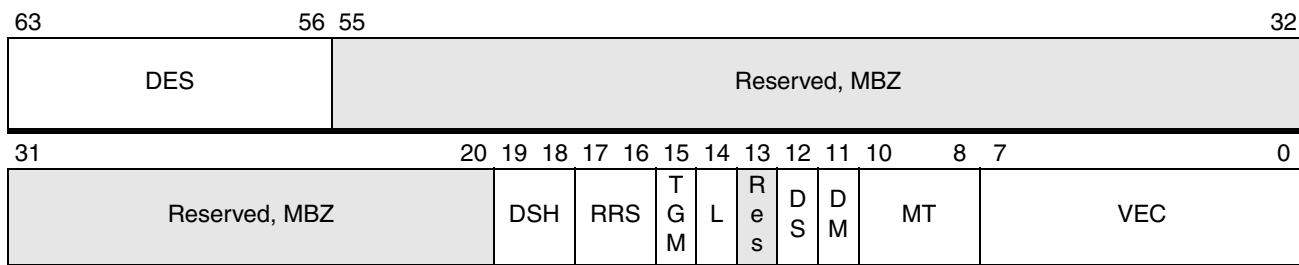

Bits	Mnemonic	Description	R/W
63-56	DES	Destination	R/W
55-20	Reserved	Reserved, Must be Zero	
19-18	DSH	Destination Shorthand	R/W
17-16	RRS	Remote Read Status	RO
15	TGM	Trigger Mode	R/W
14	L	Level	R/W
13	Reserved	Reserved, Must be Zero	
12	DS	Delivery Status	RO
11	DM	Destination Mode	R/W
10-8	MT	Message Type	R/W
7-0	VEC	Vector	R/W

Figure 16-17. Interrupt Command Register (APIC Offset 310:300h)

The fields within the Interrupt Command register are as follows:

- *Vector (VEC)*—Bits 7-0. The function of this field varies with the Message Type field. The VEC field contains the vector that is sent for this interrupt source for fixed and lowest priority message types.

- *Message Type (MT)*—Bits 10-8. The MT field specifies the message type sent to the CPU core interrupt handler. The legal values are:
 - 000b = Fixed - The IPI delivers an interrupt to the target local APIC specified in Destination field.
 - 001b = Lowest Priority - The IPI delivers an interrupt to the local APIC executing at the lowest priority of all local APICs that match the destination logical ID specified in the Destination field. See Section 16.6.1, “Receiving System and IPI Interrupts,” on page 442.
 - 010b = SMI - The IPI delivers an SMI interrupt to target local APIC(s). The trigger mode is edge-triggered and the Vector field must = 00h.
 - 011b = Remote read - The IPI delivers a read request to read an APIC register in the target local APIC specified in Destination field. The trigger mode is edge triggered and the Vector field specifies the APIC offset of the APIC register to be read. The Remote Status field provides the current status of the remote read access after it has been issued. Data is returned from the target local APIC and captured in the Remote Read Register of the issuing local APIC. See Figure 16-18 on page 441.
 - 100b = NMI - The IPI delivers a non-maskable interrupt to the target local APIC specified in the Destination field. The Vector field is ignored.
 - 101b = INIT - The IPI delivers an INIT request to the target local APIC(s) specified in the Destination field, causing the CPU core to assume the INIT state. The trigger mode is edge-triggered, and the Vector field must =00h.
 - 110b = Startup - The IPI delivers a start-up request (SIPI) to the target local APIC(s) specified in Destination field, causing the CPU core to start processing the BIOS boot-strap routine whose address is specified by the Vector field.
 - 111b = External interrupt - The IPI delivers an external interrupt to the target local APIC specified in Destination field. The interrupt can be delivered even if the APIC is disabled.
- *Destination Mode (DM)*—Bit 11. The DM bit when set to 1 specifies a logical destination which may be one or more local APICs with a common destination logical ID. When cleared to 0, the DM bit specifies a physical destination which indicates a single local APIC ID.
- *Delivery Status (DS)*—Bit 12. The DS bit indicates the interrupt delivery status. The DS bit is set to 1 when the local APIC has sent the IPI is waiting for it to be accepted by another local APIC (the ICR is not idle). Clearing the DS bit indicates that the target local APIC is idle.
- *Level (L)*—Bit 14. The L bit when set to 1 indicates assert. Clearing the L bit to 0 indicates deassert.
- *Trigger Mode (TGM)*—Bit 15. Specifies how IPIs to the local APIC are triggered. The TGM bit is set to 1 when the interrupt is level-sensitive. It is cleared to 0 when the interrupt is edge-triggered.
- *Remote Read Status (RRS)*—Bits 17-16. The RRS field indicates the current read status of a Remote Read from another local APIC. The encoding for this field is as follows:
 - 00b = Read was invalid
 - 01b = Delivery pending

- 10b = Delivery done and access was valid. Data available in Remote Read Register.
- 11b = Reserved
- *Destination Shorthand (DSH)*—Bits 19-18. The DSH field indicates whether a shorthand notation is used, and provides a quick way to specify a destination for a message. It replaces the Destination field, when the destination field is not required (DS>00b), allowing software to use a single write to the low order ICR. The encoding are as follows:
 - 00b = Destination - The Destination field is required to specify the destination.
 - 01b = Self - The issuing APIC is the only destination.
 - 10b = All including self - The IPI is sent to all local APICs including itself (destination field=FFh).
 - 11b = All excluding self - The IPI is sent to all local APICs except itself (destination field=FFh).

Note that if the lowest priority is used, the message could end up being reflected back to this local APIC. If DS=1xb, the destination mode is ignored and physical is automatically used.
- *Destination (DES)*—Bits 63-56. The DES field identifies the target local APIC(s) for the IPI and contains the destination encoding used when the Destination Shorthand field=00b. The field indicates the target local APIC when the destination mode=0 (physical), and the destination logical ID (as indicated by LDR and DFR) when the destination mode=1 (logical).

31	RRD	0
Bits	Mnemonic	Description
31-0	RRD	Remote Read Data
		R/W
		RO

Figure 16-18. Remote Read Register (APIC Offset C0h)

- *Remote Read Data (RRD)*—Bits 31-0. The RRD field contains the data resulting from a valid completion of a remote read interprocessor interrupt.

Not all combinations of ICR fields are valid. Only the combinations indicated in Table 16-4 are valid.

Table 16-4. Valid ICR Field Combinations

Message Type	Trigger Mode	Level	Destination Shorthand
Fixed	Edge	x	x
	Level	Assert	x
Lowest Priority, SMI, NMI, INIT	Edge	x	Destination or all excluding self.
	Level	Assert	Destination or all excluding self
Startup	x	x	Destination or all excluding self

Note: x indicates a don't care.

16.6 Local APIC Handling of Interrupts

16.6.1 Receiving System and IPI Interrupts

Each local APIC verifies the destination ID, the destination mode and the message type of an APIC interrupt to determine if it is the target of the interrupt.

The destination mode is either physical or logical. In physical destination mode, the APIC ID of the destination is compared with the unique APIC ID value of each local APIC to select the target local APIC. If the destination APIC ID=FFh, the interrupt is broadcasted and accepted by all local APICs. In physical destination mode, the lowest priority message type is not supported.

In logical destination mode, all local APICs use the Logical Destination Register and the Destination Format Register to determine if the interrupt is directed to them. The logical ID of the destination is compared with the value in the Logical Destination Register (see Figure 16-19) of all local APICs. This value is loaded by software and is not unique, allowing for the interrupt to be sent to a group of local APICs for handling.

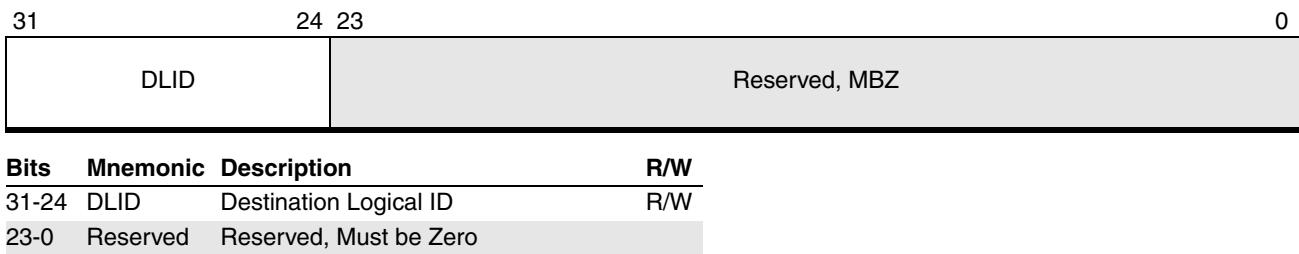

Figure 16-19. Logical Destination Register (APIC Offset D0h)

- *Destination Logical ID (DLID)*—Bits 31-24. The DLID field contains the logical APIC ID assigned to this specific CPU core. The logical APIC ID is not unique, allowing for interrupts to be sent to multiple local APICs.

Two interrupt models are defined for the logical destination mode, the flat model and the cluster model, under the control of the Destination Format Register. See Figure 16-20.

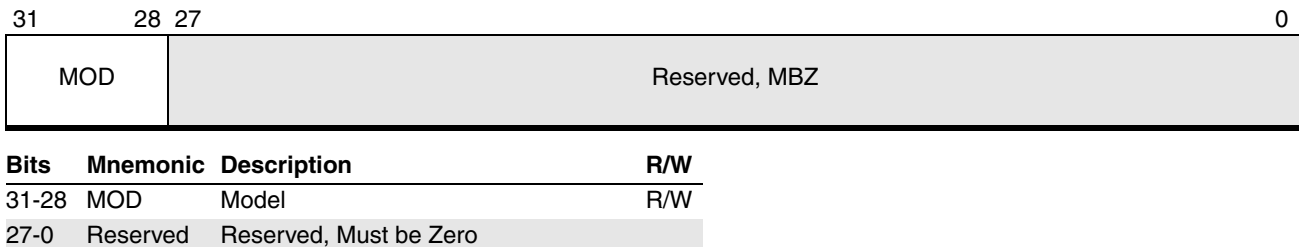

Figure 16-20. Destination Format Register (APIC Offset E0h)

- *Model (MOD)*—Bits 31-28. The MOD field controls which format to use when accepting interrupts in logical destination mode. The allowable values are 0h= cluster model and Fh=flat model.

With the flat model, up to eight unique logical APIC ID values can be provided by software by setting a different bit in the LDR. When the logical ID of the destination is compared with the LDR, if any bit position is set in both fields, this local APIC is a valid destination. A broadcast to all local APICs occurs when the LDR is set to all ones.

In the cluster model, bits 31:28 of the logical ID of the destination are compared with bits 31:28 of the LDR. If there is a match, then bits 27:24 are tested for matching ones, similar to the flat model. If bits 31:28 match, and any of bits 27:24 are set in both fields, this local APIC is a valid destination. The cluster model allows for 15 unique clusters to be defined, with each cluster having four unique logical APIC values to be addressed. In cluster logical destination mode, lowest priority message type is not supported.

In both the flat model and the cluster model, if the destination field = FFh, the interrupt is accepted by all local APICs.

16.6.2 Lowest Priority Messages and Arbitration

In the case where the interrupt is valid for several local APICs in logical destination mode with a lowest priority message type, the interrupt is accepted by the local APIC with the lowest arbitration priority, as indicated by the *Arbitration Priority* field in the Arbitration Priority Register (APR). The value in the *Arbitration Priority* field indicates the current priority for a pending interrupt or task, or an interrupt being serviced by the CPU core. See Figure 16-21.

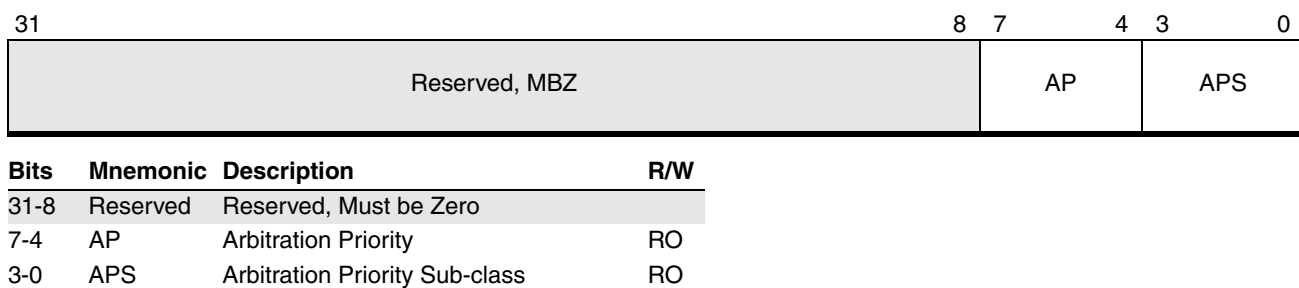

Figure 16-21. Arbitration Priority Register (APIC Offset 90h)

The fields within the Arbitration Priority register are as follows:

- *Arbitration Priority Sub-class (APS)*—Bits 3-0. The APS field indicates the current sub-priority to handle arbitrated interrupts to be serviced by the CPU core.
- *Arbitration Priority (AP)*—Bits 7-4. The AP field indicates the current priority to handle arbitrated interrupts to be serviced by the CPU core. The priority is used to arbitrate between CPU cores to determine which core accepts a lowest-priority interrupt request.

The value in the Arbitration Priority field is equal to the highest priority of the Task Priority field of the Task Priority Register (TPR), the highest bit set in the In-Service Register (ISR) vector, or the highest bit set in the Interrupt Request Register (IRR) vector. The value in the Arbitration Priority Sub-class field is equal to the Task Priority Sub-class if the APR is equal to the TPR, and zero otherwise.

If focus CPU core checking is enabled (Spurious Interrupt Register bit 9=0), the focus CPU core for an interrupt can always accept the interrupt. A CPU core is the focus of an interrupt if it is already servicing that interrupt (corresponding ISR bit is set) or if it already has a pending request for that interrupt (corresponding IRR bit is set). If there is no focus CPU core for an interrupt or if focus CPU core checking is disabled (Spurious Interrupt Register bit 9=1), all target local APICs identified as candidates for the interrupt arbitrate to determine which is executing with the lowest arbitration priority. If there is a tie for lowest priority, the local APIC with the highest APIC ID is selected.

16.6.3 Accepting System and IPI Interrupts

If the local APIC accepting the interrupt determines that the message type for the interrupt request indicates SMI, NMI, INIT, STARTUP or ExtINT, it sends the interrupt directly to the CPU core for handling. If the message type is fixed or lowest priority, the accepting local APIC places the interrupt into an open slot in either the IRR or ISR registers. If there is no free slot, the interrupt is rejected and sent back to the sender with a retry request.

Three 256-bit acceptance registers support interrupts accepted by the local APIC. Bits 255:16 correspond to interrupt vectors 255:16 with 255 being the highest priority; bits 15:0 are reserved.

- Interrupt Request Register (IRR), which contains interrupt requests that have been accepted but have not been sent to the CPU core for interrupt handling. When a system interrupt is accepted, the associated bit corresponding to the interrupt vector is set in the IRR. When the CPU core requests a new interrupt, the local APIC selects the highest priority IRR interrupt and sends it to the CPU core. The local APIC then sets the corresponding bit in the ISR and resets the associated IRR bit. See Figure 16-22 on page 445.
- In-Service Register (ISR) contains the bit map of the interrupts that have been sent to the CPU core and are still being serviced. When the CPU core writes to the EOI register indicating completion of the interrupt processing, the associated ISR bit is reset and a new interrupt is selected from the IRR register. If a higher priority interrupt is accepted by the local APIC while the CPU core is servicing another interrupt, the higher priority interrupt is sent directly to the CPU core (before the current interrupt finishes processing) and the associated IRR bit is set. The CPU core interrupts the current interrupt handler to service the higher priority interrupt. When the interrupt handler for the higher priority interrupt completes, the associated IRR bit is reset and the interrupt handler returns to complete the previous interrupt handler routine. If a second interrupt with the same interrupt vector number is received by the local APIC while the IRR bit is set, the local APIC sets the ISR bit. No more than two interrupts can be pending for the same interrupt vector number. Subsequent interrupt requests to the same interrupt vector number will be rejected. See Figure 16-23 on page 445.
- Trigger Mode Register (TMR) indicates the trigger mode of the interrupt and determines whether an EOI message is sent to the I/O APIC for level-sensitive interrupts. When the interrupt is

accepted by the local APIC and the IRR bit is set, the associated TMR bit is set for level-sensitive interrupts or reset for edge-triggered interrupts. At the end of the interrupt handler routine, when the EOI is received at the local APIC, an EOI message is sent to the I/O APIC if the associated TMR bit is set for a system interrupt. See Figure 16-24 on page 446.

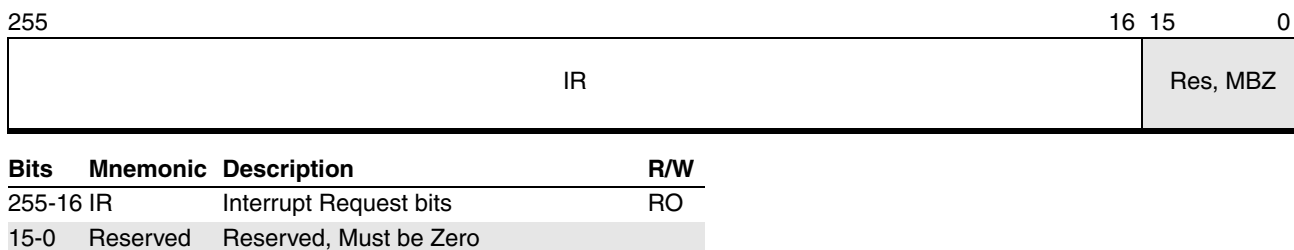

Figure 16-22. Interrupt Request Register (APIC Offset 270:200h)

- *Interrupt Request bits (IR)*—Bits 255-16. The corresponding request bit is set when an interrupt is accepted by the local APIC. The interrupt request registers provide a bit per interrupt to indicate that the corresponding interrupt has been accepted by the local APIC. Interrupts are mapped as follows:

Register	Interrupt Number
IRR (APIC offset 200h)	31–16
IRR (APIC offset 210h)	63–32
IRR (APIC offset 220h)	95–64
IRR (APIC offset 230h)	127–96
IRR (APIC offset 240h)	159–128
IRR (APIC offset 250h)	191–160
IRR (APIC offset 260h)	223–192
IRR (APIC offset 270h)	255–224

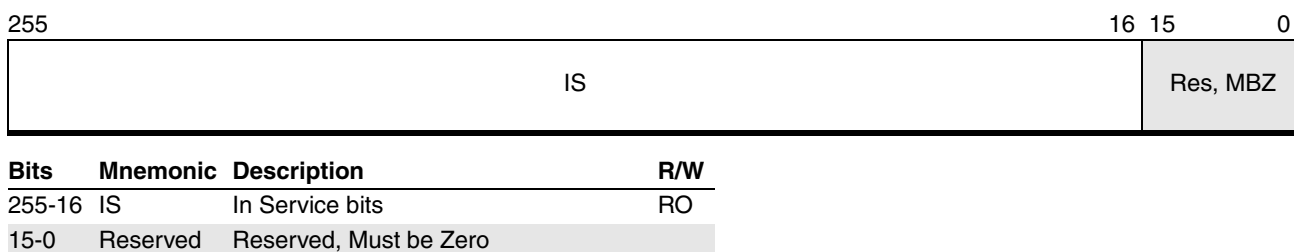
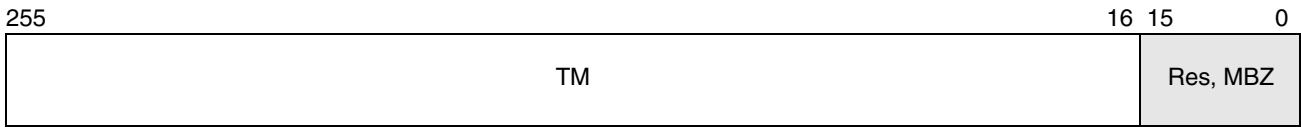

Figure 16-23. In Service Register (APIC Offset 170:100h)

- *In Service bits (IS)*—Bits 255–16. These bits are set when the corresponding interrupt is being serviced by the CPU core. The in-service registers provide a bit per interrupt to indicate that the corresponding interrupt is being serviced by the CPU core. Interrupts are mapped as follows:

Register	Interrupt Number
ISR (APIC offset 100h)	31–16
ISR (APIC offset 110h)	63–32
ISR (APIC offset 120h)	95–64
ISR (APIC offset 130h)	127–96
ISR (APIC offset 140h)	159–128
ISR (APIC offset 150h)	191–160
ISR (APIC offset 160h)	223–192
ISR (APIC offset 170h)	255–224



Bits	Mnemonic	Description	R/W
255-16	TM	Trigger Mode bits	RO
15-0	Reserved	Reserved, Must be Zero	

Figure 16-24. Trigger Mode Register (APIC Offset 1F0:180h)

- *Trigger Mode bits (TM)*—Bits 255–16. These bits provide a bit per interrupt to indicate the assertion mode of each interrupt. Interrupts are mapped as follows:

Register	Interrupt Number
TMR (APIC offset 180h)	31–16
TMR (APIC offset 190h)	63–32
TMR (APIC offset 1A0h)	95–64
TMR (APIC offset 1B0h)	127–96
TMR (APIC offset 1C0h)	159–128
TMR (APIC offset 1D0h)	191–160
TMR (APIC offset 1E0h)	223–192
TMR (APIC offset 1F0h)	255–224

16.6.4 Selecting and Handling Interrupts

Interrupts are selected by the local APIC for delivery to the CPU core interrupt handler on a priority determined by the interrupt vector number. Of the 15 priority levels, 15 is the highest and 1 is the lowest. The priority level for an interrupt is equal to the interrupt vector number divided by 16, rounded down to the nearest integer, with vector 0F:00h reserved. Therefore, interrupt vectors 79h and 70h have the same priority level. The high-order hex digit indicates the priority level while the low-order hex digit indicates the priority within the same priority level.

Two registers are used to determine the priority threshold for selecting interrupts to be delivered to the CPU core, the Task Priority Register (TPR) and the Processor Priority Register (PPR). Software uses the TPR to set a priority threshold for interrupts to the CPU core, allowing the OS to block specific interrupts. See Figure 16-25 on page 447 for more details on the TPR.

The value in the *Task Priority* field is set by software to set a threshold priority at which the processor is to be interrupted. The value varies from 0 (all interrupts are allowed) to 15 (all interrupts with fixed delivery mode are inhibited). See Figure 16-25.

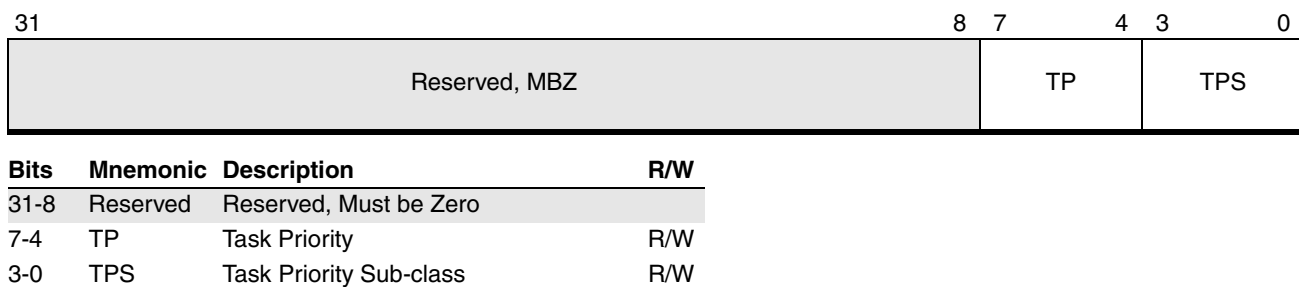

Figure 16-25. Task Priority Register (APIC Offset 80h)

The fields within the Task Priority register are as follows:

- *Task Priority Sub-class (TPS)*—Bits 3–0. The TPS field indicates the current sub-priority to be used when arbitrating lowest-priority messages. This field is written with zero when TPR is written using the architectural CR8 register.
- *Task Priority (TP)*—Bits 7–4. The TP field indicates the current priority to be used when a core is deciding when to handle interrupts. A value of zero allows all interrupts; a value of Fh disables all interrupts. TP is also used to arbitrate between CPU cores to determine which core accepts a lowest-priority interrupt request. This field can also be written using the architectural CR8 register.

The PPR is set by the CPU core and represents the current priority level at which the CPU core is executing. The PPR determines whether a pending interrupt in the local APIC can be selected for interrupt handling in the CPU core. The value set by hardware is either the interrupt priority level of the highest priority ISR bit set or the value in the TPR, whichever is higher. The PPR is equal to the TPR when the CPU core is not servicing a higher priority interrupt. See Figure 16-26 on page 448.

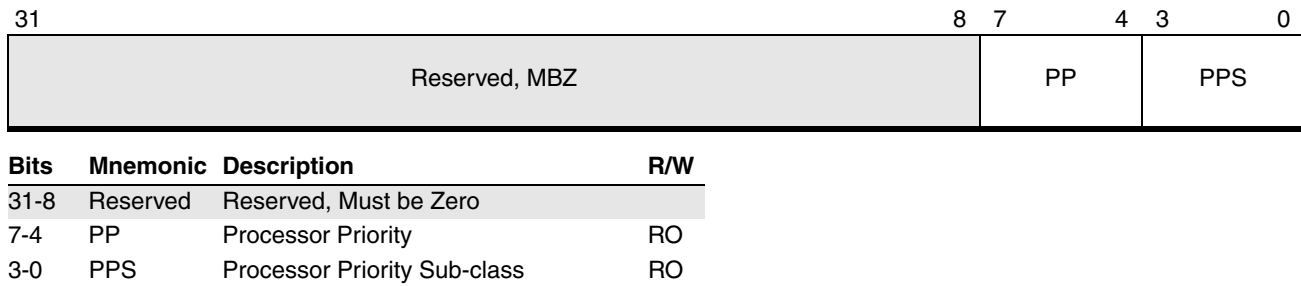

Figure 16-26. Processor Priority Register (APIC Offset A0h)

The fields within the Processor Priority register are as follows:

- *Processor Priority Sub-class (PPS)*—Bits 3-0. The PPS field is set to the Task Priority sub-class field of the Task Priority Register (TPR) if the PP field is equal to the Task Priority field of the TPR.
- *Processor Priority (PP)*—Bits 7-4. The PP field indicates the CPU core's current priority for servicing a task or interrupt, and is used to determine if any pending interrupts should be serviced. It is the higher value of either the interrupt priority level of the highest priority ISR bit set or the value in the TPR.

Pending interrupts must have a higher priority level than the value in the PPR to be selected by the local APIC for interrupt handling in the core; otherwise, they remain pending in the IRR until the PPR is lowered below the pending interrupt priority level. No pending interrupts are selected by the local APIC when the TPR=15.

The local APIC selects the highest priority pending interrupt (highest priority IRR) when the CPU core is ready, and sends the interrupt (with the IRR vector) to the CPU core. The local APIC resets the highest priority IRR bit and sets the associated ISR bit.

As part of the completion of the interrupt handling routine, software writes a value of zero to the End-of-Interrupt Register (EOI) in the local APIC, which causes the local APIC to reset the associated ISR bit. The EOI register is a write-only register.

If a higher priority interrupt is accepted by the local APIC while the CPU core is servicing another interrupt, the higher priority interrupt is sent directly to the CPU core (before the current interrupt finishes processing) and the associated IRR bit is set. The CPU core interrupts the current interrupt handler to service the higher priority interrupt. When the interrupt handler for the higher priority interrupt completes, the associated IRR bit is reset and the interrupt handler returns to complete the previous interrupt handler routine.

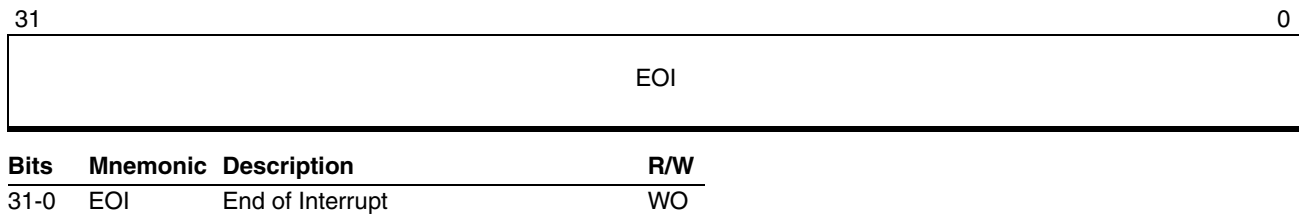

Figure 16-27. End of Interrupt (APIC Offset B0h)

- *End of Interrupt (EOI)*—Bits 31-0. Write-only operation signals end of interrupt processing to source of interrupt.

16.7 SVM Support for Interrupts and the Local APIC

The SVM hypervisor uses the Extended APIC Feature Register, Extended APIC Control Register, Specific End of Interrupt Register (SEOI), and Interrupt Enable Register (IER) to control virtualized interrupts. When guests have direct access to devices, interrupts arriving at the local APIC can usually be dismissed only by the guest that owns the device causing the interrupt. To prevent one guest from blocking other guests' interrupts (by never processing their own), the VMM can mask pending interrupts in the local APIC, so they do not participate in the prioritization of other interrupts.

16.7.1 Extended APIC Feature Register

The Extended APIC Feature Register indicates the number of extended Local Vector Table registers in the local APIC, whether the Interrupt Enable Registers are present, and whether the 8-bit Extended APIC ID and Specific End Of Interrupt (SEOI) Register are supported.

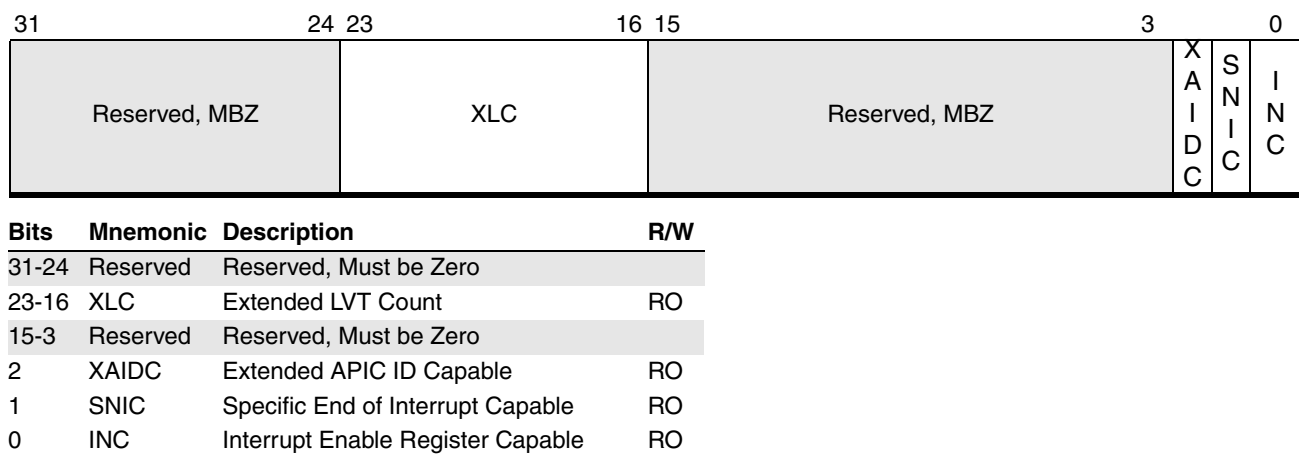

Figure 16-28. Extended APIC Feature Register (APIC Offset 400h)

- Extended LVT Count (XLC)—(Bits 23–16) Specifies the number of extended local vector table registers in the local APIC.
- Extended APIC ID Capability (XAIDC)—(Bit 2) Indicates that the processor is capable of supporting an 8-bit APIC ID.
- Specific End of Interrupt Capable—(Bit 1) Indicates that the Specific End Of Interrupt Register is present.
- Interrupt Enable Register Capable—(Bit 0) Read-only. Indicates that the Interrupt Enable Registers are present.

16.7.2 Specific End of Interrupt Register

Software issues a specific EOI (SEOI) by writing the vector number of the interrupt to the new SEOI register in the local APIC. The SEOI register is located at offset 420h in the APIC space. The SEOI register format is shown in Figure 16-29.

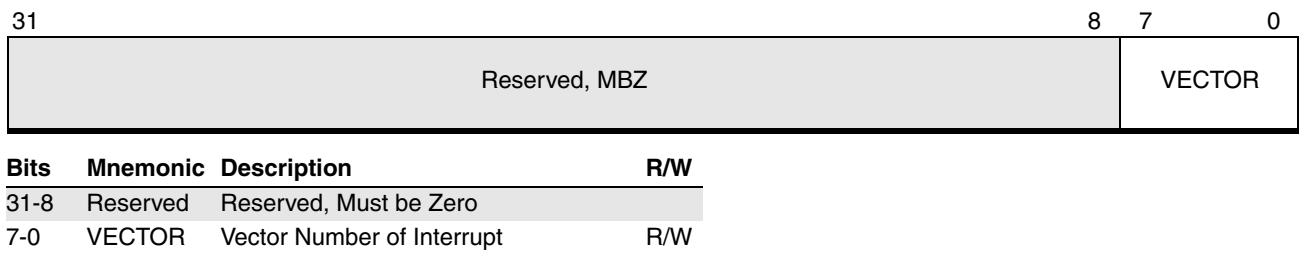

Figure 16-29. Specific End of Interrupt (APIC Offset 420h)

The IER is made available to software by means of eight 32-bit registers in the local APIC; bit *i* of the 256-bit IER is located at bit position (*i* mod 32) in the local APIC register IER[*i* / 32]. The eight IER registers are located at offsets 480h, 490h, ...,4F0h in APIC space. The IER format is shown in Figure 16-30.

16.7.3 Interrupt Enable Register

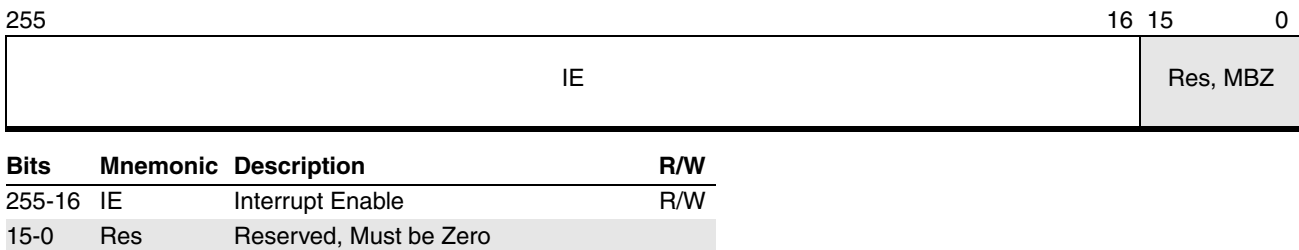

Figure 16-30. Interrupt Enable Register (APIC Offset 4F0:480h)

- *Interrupt Enable (IE)*—Bits 255–16. Interrupts are mapped as follows:

Register	Interrupt Number
IER (APIC offset 480h)	31–16
IER (APIC offset 490h)	63–32
IER (APIC offset 4A0h)	95–64
IER (APIC offset 4B0h)	127–96
IER (APIC offset 4C0h)	159–128
IER (APIC offset 4D0h)	191–160
IER (APIC offset 4E0h)	223–192
IER (APIC offset 4F0h)	255–224

The IER and SEOI registers are located in the APIC Extended Space area. The presence of the APIC Extended Space area is indicated by bit 31 of the APIC Version Register (at offset 30h in APIC space).

The presence of the IER and SEOI functionality is identified by bits 0 and 1, respectively, of the APIC Extended Feature Register (located at offset 400h in APIC space). IER and SEOI are enabled by setting bits 0 and 1, respectively, of the APIC Extended Control Register (located at offset 410h).

Only vectors that are enabled in IER participate in APIC's computation of the highest-priority pending interrupt. The reset value of IER is all ones.

17 OS-Visible Workaround Information

Operating systems may provide a workaround for hardware errata. These operating system-visible workarounds (OSVW) may be temporary and should be removed when an erratum is corrected on hardware in a subsequent release.

Hardware provides software with a mechanism for determining the up-to-date status of OSVWs. Support for this feature is indicated by ECX bit 9 as returned by CPUID function 8000_0001h.

A unique OSVW ID number is assigned to each erratum. The OSVW ID number corresponds exactly to the same status bit (En) in the OSVW MSR $I-N$. The OSVW ID number and bit position for the erratum, once assigned, are global across all AMD processors; the OSVW ID and bit position will not be re-used. The OSVW ID range starts at 0, which corresponds to bit 0 of OSVW MSR1.

The OSVW MSRs are defined as follows:

- OSVW MSR0 contains the OSVW_ID_Length field that indicates the highest OSVW ID number assigned in the current hardware release. Refer to Figure 17-1 for the MSR format.
- OSVW MSR $I-n$ contains the variable length bit status field, where each bit indicates that a processor model is affected by OS-visible erratum, and whether the OS needs to apply a workaround. Refer to Figure 17-2 and Figure 17-3 on page 454 for the MSR format.

The bank of OSVW MSRs are located at address C001_0140h, starting with OSVW MSR0.

The OSVW MSRs are meant as read-only registers for OS. The OS should never write into these registers. Hardware allows BIOS writes to these registers.



Bits	Mnemonic	Description	R/W
63–16	Reserved		
15–0	OSVW_ID_Length	Highest OSVW ID	R/W

Figure 17-1. OSVW MSR0: OSVW_ID_Length

OSVW_ID_Length—Bits 15–0. The highest OSVW_ID erratum number supported in the latest release. If a specific erratum has an OSVW ID that is greater than OSVW_ID_Length, the erratum is unknown to the latest release. Otherwise, the associated status bit in the OSVW MSR $I-n$ can be checked to see if a workaround is required. Reset is the highest OSVW_ID of erratum known at time of release.



Figure 17-2. OSVW MSR1: OSVW Status



Bits	Mnemonic	Description	R/W
$n-0$	OSVW E[i]	OS valid workaround status	R/W

Figure 17-3. OSVW MSR n : OSVW Status

OS Valid Workaround Status (OSVW E[i])—Bits $n-0$. Each bit indicates that a processor model is affected by OS-visible erratum and whether the OS needs to apply a workaround. The OSVW_ID_Length indicates the highest OSVW_ID for known errata at the time of release. If a specific erratum has a lower or equal OSVW_ID than the OSVW_ID_Length, the workaround information is contained in the corresponding status bit in the OSVW Status register.

For the status bit:

- 1 = Hardware contains the erratum, and an OS software workaround is required.
- 0 = Hardware has corrected the erratum, so an OS software workaround is not necessary.

The location of an OSVW ID status bit within a bank of OSVW MSRs is determined as follows:

- MSR address = OSVW_MSR0 + 1 + floor (OSVW_ID /64)
- Bit offset in MSR = OSVW_ID mod 64

If a specific erratum has an OSVW_ID that is greater than the OSVW_ID_LENGTH, hardware does not know about the erratum and the processor model must be used to determine whether the workaround must be applied. Reset is the array of workaround status known at time of processor release.

17.1 Erratum Process Overview

Following is an overview of the AMD erratum process:

- When an OS-visible erratum is discovered, AMD assigns a unique OSVW ID to the erratum and publishes to OS vendors the starting range of affected processor models and suggested workarounds.
- AMD works with BIOS vendors and OEMs in parallel to develop a firmware update to extend the OSVW_ID_Length field in OSVW MSR0 to include the new OSVW ID and set the associated status bit in OSVW MSR1-N to report the new OSVW ID as requiring a workaround.
- OS vendors schedule the workaround into their release schedules and eventually release it.
- The OS detection logic for the workaround first checks whether the processor OSVW MSRs record the erratum by comparing the OSVW ID of the erratum with the OSVW_ID_Length field in OSVW MSR0.
- If the erratum OSVW ID is greater than the OSVW_ID_length, the current hardware does not know about this erratum. In this case, the OS compares the processor model ID with the starting model ID that AMD supplied with the erratum to determine if the workaround should be applied.
- If the errata OSVW ID is less than or equal to the OSVW_ID_Length, the hardware is aware of the errata. In this case, the OS uses the state of the associated OSVW ID status bit to conditionally apply the workaround. If the associated status bit=1, the workaround is applied.
- Once AMD fixes the erratum in a future release, the associated OSVW status bit is reset, indicating that the workaround is no longer necessary. As a result, the OS detection logic does not apply to the workaround.

18 Hardware P-State Control

P-states are operational performance states (states in which the processor is executing instructions, i.e., running software) characterized by unique frequency of operation for a CPU core. The hardware P-state control interface supports dynamic P-state changes in up to 16 P-states called P-states 0 through 15 or P0 through P15. P0 is the highest power, highest performance P-state; each ascending P-state number represents a lower-power, lower performance P-state than the prior P-state number.

Core P-states are dynamically controlled by software. Each CPU core contains one set of P-state control registers. Software controls the P-states of each CPU core independently; however, hardware may include interdependencies that affect the P-state achieved by each core.

Hardware provides the highest P-state value in the PstateMaxVal field of the P-State Current Limit Register. P-states may be limited to a lower performance value under certain conditions. The current P-state limit is dynamic and is specified in the CurPstateLimit field of the P-State Current Limit Register.

Software requests a core P-state change by writing a 4-bit index corresponding to the desired core P-state number to the P-State Control Register of the appropriate core. For example, to request the P3 state for core 0, software would write 3h to the core 0's PstateCmd field in MSR C001_0062h. If the P-state value is greater than the value in PstateMaxVal, the value written is clipped to that value.

As the current P-state limit changes, the P-state for the CPU core is either set to the software-requested P-state value or the new current P-state limit, whichever is the higher P-state value.

The current P-state value can be read using the P-State Status Register. The P-State Current Limit Register and the P-State Status Register are read-only registers. Writes to these registers cause a #GP exception. Support for hardware P-state control is indicated by EDX bit 7 as returned by CPUID function 8000_0007h. Figure 18-1 shows the format of the P-State Current Limit register.



Bits	Mnemonic	Description	R/W
63–8	Reserved		
7–4	PstateMaxVal	P-state maximum value	R
3–0	CurPstateLimit	Current P-state limit	R

Figure 18-1. P-State Current Limit Register

The fields within the P-State Current Limit register are:

- *Current P-State Limit (CurPstateLimit)*—Bits 3–0. Provides the current P-state limit, which is the lowest P-state value (highest-performance state) that is currently supported by the hardware. This is a dynamic value controlled by hardware. Reset value is implementation specific.
- *P-State Maximum Value (PstateMaxVal)*—Bits 7–4. Specifies the highest P-state value (lowest performance state) supported by the hardware. Attempts to change the current P-state number to a higher value by writes to the P-State Control Register are clipped to the value of this field. Reset value is implementation specific.



Bits	Mnemonic	Description	R/W
63–4	Reserved		
3–0	PstateCmd	P-state change command	R/W

Figure 18-2. P-State Control Register

- *P-State Change Command (PstateCmd)*—Bits 3–0. Writes to this field cause the CPU core to change to the indicated P-state number, which may be clipped by the PstateMaxVal field of the P-State Current Limit Register. Reset value is implementation specific.

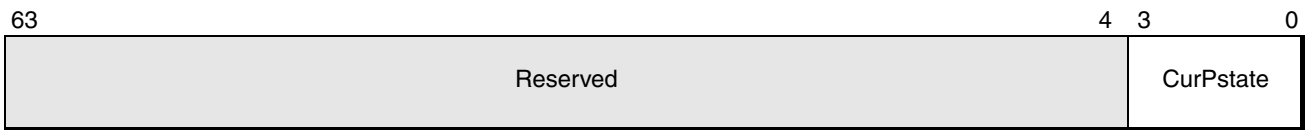

Bits	Mnemonic	Description	R/W
63–4	Reserved		
3–0	CurPstate	Current P-state	R

Figure 18-3. P-State Status Register

- *Current P-State (CurPstate)*—Bits 3–0. This field provides the current P-state of the CPU core regardless of the source of the P-state change, including writes to the P-State Control Register: 0=P-state 0, 1=P-state 1, etc. The value of this field is updated when the frequency transitions to a new value associated with the P-state. Reset value is implementation specific.

Appendix A MSR Cross-Reference

This appendix lists the MSRs that are defined in the AMD64 architecture. The AMD64 architecture supports some of the same MSRs as previous versions of the x86 architecture and implementations thereof. Where possible, the AMD64 architecture supports the same MSRs, for the same functions, as these previous architectures and implementations.

The first section lists the MSRs according to their MSR address, and it gives a cross reference for additional information. The remaining sections list the MSRs by their functional group. Those sections also give a brief description of the register and specify the register reset value.

Some MSRs are implementation-specific For information about these MSRs, see the documentation for specific implementations of the AMD64 architecture.

A.1 MSR Cross-Reference by MSR Address

Table A-1 lists the MSRs in the AMD64 architecture in order of MSR address.

Table A-1. MSRs of the AMD64 Architecture

MSR Address	MSR Name	Functional Group	Cross-Reference
0010h	TSC	Performance	“Time-Stamp Counter” on page 346
001Bh	APIC_BASE	System Software	“Local APIC Enable” on page 427
00FEh	MTRRcap	Memory Typing	“Identifying MTRR Features” on page 190
0174h	SYSENTER_CS	System Software	“SYSENTER and SYSEXIT MSRs” on page 152
0175h	SYSENTER_ESP		
0176h	SYSENTER_EIP		
0179h	MCG_CAP	Machine Check	“Machine-Check Global-Capabilities Register” on page 257
017Ah	MCG_STATUS		“Machine-Check Global-Status Register” on page 258
017Bh	MCG_CTL		“Machine-Check Global-Control Register” on page 259
01D9h	DebugCtlMSR	Software Debug	“Debug-Control MSR (DebugCtlMSR)” on page 333
01DBh	LastBranchFromIP	Software Debug	“Control-Transfer Recording MSRs” on page 334
01DCh	LastBranchToIP		
01DDh	LastExceptionFromIP		
01DEh	LastExceptionToIP		

Table A-1. MSRs of the AMD64 Architecture (continued)

MSR Address	MSR Name	Functional Group	Cross-Reference
0200h	MTRRphysBase0	Memory Typing	“Variable-Range MTRRs” on page 187
0201h	MTRRphysMask0		
0202h	MTRRphysBase1		
0203h	MTRRphysMask1		
0204h	MTRRphysBase2		
0205h	MTRRphysMask2		
0206h	MTRRphysBase3		
0207h	MTRRphysMask3		
0208h	MTRRphysBase4		
0209h	MTRRphysMask4		
020Ah	MTRRphysBase5		
020Bh	MTRRphysMask5		
020Ch	MTRRphysBase6		
020Dh	MTRRphysMask6		
020Eh	MTRRphysBase7		
020Fh	MTRRphysMask7		
0250h	MTRRfix64K_00000	Memory Typing	“Fixed-Range MTRRs” on page 185
0258h	MTRRfix16K_80000		
0259h	MTRRfix16K_A0000		
0268h	MTRRfix4K_C0000		
0269h	MTRRfix4K_C8000		
026Ah	MTRRfix4K_D0000		
026Bh	MTRRfix4K_D8000		
026Ch	MTRRfix4K_E0000		
026Dh	MTRRfix4K_E8000		
026Eh	MTRRfix4K_F0000		
026Fh	MTRRfix4K_F8000		
0277h	PAT	Memory Typing	“PAT Register” on page 193
02FFh	MTRRdefType		“Default-Range MTRRs” on page 189
0400h	MC0_CTL	Machine Check	See the documentation for particular implementations of the architecture.
0404h	MC1_CTL		
0408h	MC2_CTL		
040Ch	MC3_CTL		
0410h	MC4_CTL		
0414h	MC5_CTL		

Table A-1. MSRs of the AMD64 Architecture (continued)

MSR Address	MSR Name	Functional Group	Cross-Reference
0401h	MC0_STATUS	Machine Check	“Machine-Check Status Registers” on page 261
0405h	MC1_STATUS		
0409h	MC2_STATUS		
040Dh	MC3_STATUS		
0411h	MC4_STATUS		
0415h	MC5_STATUS		
0402h	MC0_ADDR	Machine Check	“Machine-Check Address Registers” on page 264
0406h	MC1_ADDR		
040Ah	MC2_ADDR		
040Eh	MC3_ADDR		
0412h	MC4_ADDR		
0416h	MC5_ADDR		
0403h	MC0_MISC	Machine Check	“Machine-Check Miscellaneous-Error Information Registers (MCi_MISCj)” on page 264
0407h	MC1_MISC		
040Bh	MC2_MISC		
040Fh	MC3_MISC		
0413h	MC4_MISC		
0417h	MC5_MISC		
C000_0080h	EFER	System Software	“Extended Feature Enable Register (EFER)” on page 54
C000_0081h	STAR	System Software	“SYSCALL and SYSRET MSRs” on page 150
C000_0082h	LSTAR		
C000_0083h	CSTAR		
C000_0084h	SF_MASK		
C000_0100h	FS.Base	System Software	“FS and GS Registers in 64-Bit Mode” on page 70
C000_0101h	GS.Base		
C000_0102h	KernelGSbase	System Software	“SWAPGS Instruction” on page 152
C000_0103h	TSC_AUX	System Software	“RDTSCP Instruction” on page 154
C000_0408h	MC4_MISC1	Machine Check	“Machine-Check Miscellaneous-Error Information Registers (MCi_MISCj)” on page 264
C000_0409h	MC4_MISC2		
C000_040Ah	MC4_MISC3		

Table A-1. MSRs of the AMD64 Architecture (continued)

MSR Address	MSR Name	Functional Group	Cross-Reference
C001_0000h	PerfEvtSel0	Performance	“Performance Event-Select Registers” on page 343
C001_0001h	PerfEvtSel1		
C001_0002h	PerfEvtSel2		
C001_0003h	PerfEvtSel3		
C001_0004h	PerfCtr0	Performance	“Performance Counters” on page 342
C001_0005h	PerfCtr1		
C001_0006h	PerfCtr2		
C001_0007h	PerfCtr3		
C001_0010h	SYSCFG	Memory Typing	“System Configuration Register (SYSCFG)” on page 57
C001_0016h	IORRBase0	Memory Typing	“IORRs” on page 199
C001_0017h	IORRMask0		
C001_0018h	IORRBase1		
C001_0019h	IORRMask1		
C001_001Ah	TOP_MEM	Memory Typing	“Top of Memory” on page 201
C001_001Dh	TOP_MEM2		
C001_0030h	Processor_Name_String	CPUID Name	See appropriate BIOS and kernel developer’s guide for details.
C001_0031h			
C001_0032h			
C001_0033h			
C001_0034h			
C001_0035h			
C001_0061h	P-State Current Limit	SMM	“Hardware P-State Control” on page 457
C001_0062h	P-State Control		
C001_0063h	P-State Status		
C001_0074h	CPU_Watchdog_Timer	Machine Check	“CPU Watchdog Timer Register” on page 259
C001_0111h	SMBASE	SMM	“SMBASE Register” on page 273
C001_0112h	SMM_ADDR		“SMRAM Protected Area” on page 279
C001_0113h	SMM_MASK		
C001_0114h	VM_CR	SVM	“SVM Related MSRs” on page 420
C001_0115h	IGNNE	SVM	“SVM Related MSRs” on page 420
C001_0116h	SMM_CTL	SVM	“SVM Related MSRs” on page 420
C001_0117h	VM_HSAVE_PA	SVM	“SVM Related MSRs” on page 420
C001_0118h	SVM_KEY_MSR	SVM	“SVM-Lock” on page 422
C001_0119h	SMM_KEY_MSR	SMM	“SMM-Lock” on page 422

Table A-1. MSRs of the AMD64 Architecture (continued)

MSR Address	MSR Name	Functional Group	Cross-Reference
C001_011Ah	Local_SMI_Status	SMM	See appropriate BIOS and kernel developer's guide for details.
C001_0056h	SMI_Trigger_IO_Cycle		
C001_0140h	OSVW_ID_Length	OSVM	"OS-Visible Workaround Information" on page 453
C001_0141h	OSVM Status		

A.2 System-Software MSRs

Table A-2 lists the MSRs defined for general use by system software in controlling long mode and in allowing fast control transfers between applications and the operating system.

Table A-2. System-Software MSR Cross-Reference

MSR Address	MSR Name	Description	Reset Value
0000_001Bh	APIC_BASE	See appropriate BIOS and kernel developer's guide for details.	0000_0000_FEE0_0x00h
C000_0080h	EFER	Contains control bits that enable extended features supported by the processor, including long mode.	0000_0000_0000_0000h
C000_0081h	STAR	In legacy mode, used to specify the target address of a SYSCALL instruction, as well as the CS and SS selectors of the called and returned procedures.	undefined
C000_0082h	LSTAR	In 64-bit mode, used to specify the target RIP of a SYSCALL instruction.	undefined
C000_0083h	CSTAR	In compatibility mode, used to specify the target RIP of a SYSCALL instruction.	undefined
C000_0084h	SF_MASK	SYSCALL Flags Mask	undefined
C000_0100h	FS.Base	Contains the 64-bit base address in the hidden portion of the FS register (the base address from the FS descriptor).	0000_0000_0000_0000h
C000_0101h	GS.Base	Contains the 64-bit base address in the hidden portion of the GS register (the base address from the GS descriptor).	0000_0000_0000_0000h
C000_0102h	KernelGSbase	The SWAPGS instruction exchanges the value in KernelGSbase with the value in GS.base, providing a fast method for system software to load a pointer to system data-structures.	undefined
C000_0103h	TSC_AUX	The RDTSCP instruction copies the value of this MSR into the ECX register.	0000_0000_0000_0000h

Table A-2. System-Software MSR Cross-Reference (continued)

MSR Address	MSR Name	Description	Reset Value
0174h	SYSENTER_CS	In legacy mode, used to specify the CS selector of the procedure called by SYSENTER.	undefined
0175h	SYSENTER_ESP	In legacy mode, used to specify the stack pointer for the procedure called by SYSENTER.	undefined
0176h	SYSENTER_EIP	In legacy mode, used to specify the EIP of the procedure called by SYSENTER.	undefined

A.3 Memory-Typing MSRs

Table A-3 on page 464 lists the MSRs used to control memory-typing and the page-attribute-table mechanism.

Table A-3. Memory-Typing MSR Cross-Reference

MSR Address	MSR Name	Description	Reset Value
00FEh	MTRRcap	A <i>read-only</i> register containing information describing the level of MTRR support provided by the processor.	0000_0000_0000_0508h
0200h	MTRRphysBase0	Specifies the memory-range base address in physical-address space of a variable-range memory region. These registers also specify the memory type used for the memory region.	undefined
0202h	MTRRphysBase1		
0204h	MTRRphysBase2		
0206h	MTRRphysBase3		
0208h	MTRRphysBase4		
020Ah	MTRRphysBase5		
020Ch	MTRRphysBase6		
020Eh	MTRRphysBase7		
0201h	MTRRphysMask0	Specifies the size of a variable-range memory region.	Valid (bit 11) = 0 All Other Bits Undefined
0203h	MTRRphysMask1		
0205h	MTRRphysMask2		
0207h	MTRRphysMask3		
0209h	MTRRphysMask4		
020Bh	MTRRphysMask5		
020Dh	MTRRphysMask6		
020Fh	MTRRphysMask7		

Table A-3. Memory-Typing MSR Cross-Reference (continued)

MSR Address	MSR Name	Description	Reset Value
0250h	MTRRfix64K_00000	Fixed-range MTRRs used to characterize the first 1 Mbyte of physical memory. Each 64-bit register contains eight type fields for characterizing a total of eight memory ranges. <ul style="list-style-type: none"> MTRRfix64K_n characterizes 64 Kbyte ranges. MTRRfix16K_n characterizes 16 Kbyte ranges. MTRRfix4K_n characterizes 4 Kbyte ranges. 	undefined
0258h	MTRRfix16K_80000		
0259h	MTRRfix16K_A0000		
0268h	MTRRfix4K_C0000		
0269h	MTRRfix4K_C8000		
026Ah	MTRRfix4K_D0000		
026Bh	MTRRfix4K_D8000		
026Ch	MTRRfix4K_E0000		
026Dh	MTRRfix4K_E8000		
026Eh	MTRRfix4K_F0000		
026Fh	MTRRfix4K_F8000		
0277h	PAT	Used to extend the page-table entry format, allowing memory-type characterization on a physical-page basis.	0007_0406_0007_0406h
02FFh	MTRRdefType	Sets the default memory-type for physical addresses not within ranges established by fixed-range and variable-range MTRRs.	0000_0000_0000_0000h
C001_0010h	SYSCFG	Contains control bits for enabling and configuring system bus features.	0000_0000_0002_0601h
C001_0016h	IORRBase0	Specifies the memory-range base address in physical-address space of a variable-range I/O region.	undefined
C001_0018h	IORRBase1		
C001_0017h	IORRMask0	Specifies the size of a variable-range I/O region.	Valid (bit 11) = 0 All Other Bits Undefined
C001_0019h	IORRMask1		
C001_001Ah	TOP_MEM	Sets the boundary between system memory and memory-mapped I/O for addresses below 4 Gbytes.	0000_0000_0400_0000h
C001_001Dh	TOP_MEM2	Sets the boundary between system memory and memory-mapped I/O for addresses above 4 Gbytes.	undefined

A.4 Machine-Check MSRs

Table A-4 lists the MSRs used in support of the machine-check mechanism.

Table A-4. Machine-Check MSR Cross-Reference

MSR Address	MSR Name	Description	Reset Value
0179h	MCG_CAP	A read-only register that specifies the machine-check mechanism capabilities supported by the processor.	0000_0000_0000_010xh
017Ah	MCG_STATUS	Provides basic information about the processor state immediately after the occurrence of a machine-check error.	undefined
017Bh	MCG_CTL	Controls global reporting of machine-check errors from various sources.	0000_0000_0000_0000h
0400h	MC0_CTL	Controls error reporting for the data-cache-unit register bank.	0000_0000_0000_0000h
0404h	MC1_CTL	Controls error reporting for the instruction-cache-unit register bank.	0000_0000_0000_0000h
0408h	MC2_CTL	Controls error reporting for the bus-unit register bank.	0000_0000_0000_0000h
040Ch	MC3_CTL	Controls error reporting for the load/store-unit register bank.	0000_0000_0000_0000h
0410h	MC4_CTL	Controls error reporting for the Northbridge register bank.	0000_0000_0000_0000h
0414h	MC5_CTL	Controls error reporting for the execution unit register bank.	0000_0000_0000_0000h
0401h	MC0_STATUS	Status registers for each error-reporting register bank, used to report machine-check error information for the specified register bank.	undefined
0405h	MC1_STATUS		
0409h	MC2_STATUS		
040Dh	MC3_STATUS		
0411h	MC4_STATUS		
0415h	MC5_STATUS		
0402h	MC0_ADDR	Reports the instruction memory-address or data memory-address responsible for the machine-check error for the specified register bank.	undefined
0406h	MC1_ADDR		
040Ah	MC2_ADDR		
040Eh	MC3_ADDR		
0412h	MC4_ADDR		
0416h	MC5_ADDR		

Table A-4. Machine-Check MSR Cross-Reference (continued)

MSR Address	MSR Name	Description	Reset Value
0403h	MC0_MISC	Reports miscellaneous information about the machine-check error for the specified register bank.	c00x_xxxx_xx00_0000
0407h	MC1_MISC		
040Bh	MC2_MISC		
040Fh	MC3_MISC		
0413h	MC4_MISC		
0417h	MC5_MISC		c00x_xxxx_0000_0000
C000_0408h	MC4_MISC1		
C000_0409h	MC4_MISC2		
C000_040Ah	MC4_MISC3		
C001_0074h	CPU_Watchdog_Timer	Timer that can cause a machine check error if no operation completes after a specified time period.	0000_0000_0000_0000h

A.5 Software-Debug MSRs

Table A-5 lists the MSRs used in support of the software-debug architecture.

Table A-5. Software-Debug MSR Cross-Reference

MSR Address	MSR Name	Description	Reset Value
01D9h	DebugCtlMSR	Provides debug controls for control-transfer recording and control-transfer single stepping, and external-breakpoint reporting and trace messages.	0000_0000_0000_0000h
01DBh	LastBranchFromIP	During control-transfer recording, this register is loaded with the segment offset of the control-transfer source.	undefined
01DCh	LastBranchToIP	During control-transfer recording, this register is loaded with the segment offset of the control-transfer target.	undefined
01DDh	LastExceptionFromIP	When an interrupt occurs during control-transfer recording, this register is loaded with LastBranchFromIP before LastBranchFromIP is updated.	undefined
01DEh	LastExceptionToIP	When an interrupt occurs during control-transfer recording, this register is loaded with LastBranchToIP before LastBranchToIP is updated.	undefined

A.6 Performance-Monitoring MSRs

Table A-6 lists the MSRs used in support of performance monitoring, including the time-stamp counter.

Table A-6. Performance-Monitoring MSR Cross-Reference

MSR Address	MSR Name	Description	Reset Value
0010h	TSC	Counts processor-clock cycles. It is incremented once for each processor-clock cycle.	0000_0000_0000_0000h
C001_0000h	PerfEvtSel0	For the corresponding performance counter, this register specifies the events counted, and controls other aspects of counter operation.	undefined
C001_0001h	PerfEvtSel1		
C001_0002h	PerfEvtSel2		
C001_0003h	PerfEvtSel3		
C001_0004h	PerfCtr0	Used to count specific processor events, or the duration of events, as specified by the corresponding PerfEvtSel n register.	undefined
C001_0005h	PerfCtr1		
C001_0006h	PerfCtr2		
C001_0007h	PerfCtr3		

A.7 Secure Virtual Machine MSRs

Table A-1 lists the MSRs used in support of SVM functions.

Table A-7. Secure Virtual Machine MSR Cross-Reference

MSR Address	MSR Name	Description	Reset Value
C001_0114h	VM_CR	Controls certain global aspects of SVM.	undefined
C001_0115h	IGNNE	Sets the state of the processor-internal IGNNE signal.	
C001_0116h	SMM_CTL	Provides software control over SMM signals.	
C001_0117h	VM_HSAVE_PA	Holds the physical address of a block of memory where VMRUN saves host state, and from which #VMEXIT reloads host state.	
C001_0118h	SVM_KEY	Creates a password-protected mechanism to clear VM_CR.LOCK.	
C001_0119h	SMM_KEY	Creates a password-protected mechanism to clear SmmLock.	

A.8 System Management Mode MSR

Table A-8 lists the MSRs used in support of SMM functions.

Table A-8. System Management Mode MSR Cross-Reference

MSR Address	MSR Name	Description	Reset Value
C001_0111h	SMBASE	Contains the SMRAM base address.	0000_0000_0003_0000h
C001_0112h	SMM_ADDR	Contains the base address of protected memory for the SMM Handler.	0000_0000_0000_0000h
C001_0113h	SMM_MASK	Contains a mask which determines the size of the protected area for the SMM handler.	0000_0000_0000_0000h
C001_011Ah	Local_SMI_Status	Contains status associated with SMI sources local to the CPU core. See the appropriate BIOS and kernel developer's guide for details.	0000_0000_0000_0000h
C001_0056h	SMI_Trigger_IO_Cycle	Specifies an IO cycle that may be generated when a local SMI trigger event occurs. See the appropriate BIOS and kernel developer's guide for details.	0000_0000_0000_0000h

A.9 CPUID Name MSR Cross-Reference

Table A-9 lists the MSRs used to support CPUID namestring.

Table A-9. CPUID Namestring MSRs

MSR Address	MSR Name	Description	Reset Value
C001_0030h	Processor_Name_String	See appropriate BIOS and kernel developer's guide and processor revision guide for details.	
C001_0031h			
C001_0032h			
C001_0033h			
C001_0034h			
C001_0035h			

Appendix B Layout of VMCB

B.1 Layout of VMCB

The VMCB is divided into two areas—the first one contains various control bits including the intercept vector and the second one contains saved guest state.

Table B-1 describes the layout of the control area of the VMCB, which starts at offset zero within the VMCB page. The control area is padded to a size of 1024 bytes. All unused bytes must be zero, as they are reserved for future expansion. It is recommended that software “bzero” any newly allocated VMCB.

Table B-1. VMCB Layout, Control Area

Byte Offset	Bit(s)	Function
000h	15–0	Intercept reads of CR0–15, respectively.
	31–16	Intercept writes of CR0–15, respectively.
004h	15–0	Intercept reads of DR0–15, respectively.
	31–16	Intercept writes of DR0–15, respectively.
008h	31–0	Intercept exception vectors 0–31, respectively.
00Ch	0	Intercept INTR (physical maskable interrupt).
	1	Intercept NMI.
	2	Intercept SMI.
	3	Intercept INIT.
	4	Intercept VINTR (virtual maskable interrupt).
	5	Intercept CR0 writes that change bits other than CR0.TS or CR0.MP.
	6	Intercept reads of IDTR.
	7	Intercept reads of GDTR.
	8	Intercept reads of LDTR.
	9	Intercept reads of TR.
	10	Intercept writes of IDTR.
	11	Intercept writes of GDTR.
	12	Intercept writes of LDTR.
	13	Intercept writes of TR.
	14	Intercept RDTSC instruction.
15	Intercept RDPIC instruction.	

Table B-1. VMCB Layout, Control Area (continued)

Byte Offset	Bit(s)	Function
00Ch (continued)	16	Intercept PUSHF instruction.
	17	Intercept POPF instruction.
	18	Intercept CUID instruction.
	19	Intercept RSM instruction.
	20	Intercept IRET instruction.
	21	Intercept INT n instruction.
	22	Intercept INVD instruction.
	23	Intercept PAUSE instruction.
	24	Intercept HLT instruction.
	25	Intercept INVLPG instruction.
	26	Intercept INVLPGA instruction.
	27	IOIO_PROT—Intercept IN/OUT accesses to selected ports.
	28	MSR_PROT—intercept RDMSR or WRMSR accesses to selected MSRs.
	29	Intercept task switches.
30	FERR_FREEZE: intercept processor “freezing” during legacy FERR handling.	
31	Intercept shutdown events.	
010h	0	Intercept VMRUN instruction.
	1	Intercept VMCALL instruction.
	2	Intercept VMLoad instruction.
	3	Intercept VMSAVE instruction.
	4	Intercept STGI instruction.
	5	Intercept CLGI instruction.
	6	Intercept SKINIT instruction.
	7	Intercept RDTSCP instruction.
	8	Intercept ICEBP instruction.
	9	Intercept WBINVD instruction.
	10	Intercept MONITOR instruction
	11	Intercept MWAIT instruction unconditionally
	12	Intercept MWAIT instruction if Monitor hardware is armed.
	31—13	RESERVED, SBZ
014h–03Fh	RESERVED, SBZ	
040h	63–0	IOPM_BASE_PA—Physical base address of IOPM (bits 11:0 are ignored).

Table B-1. VMCB Layout, Control Area (continued)

Byte Offset	Bit(s)	Function
048h	63–0	MSRPM_BASE_PA—Physical base address of MSRPM (bits 11:0 are ignored).
050h	63–0	TSC_OFFSET—To be added in RDTSC and RDTSCP.
058h	31–0	Guest ASID.
	39–32	TLB_CONTROL—Only two values are currently defined: 0—Do nothing 1—Flush TLB on VMRUN (all entries, all ASIDs)
	63–40	RESERVED, SBZ
060h	7–0	V_TPR—The virtual TPR for the guest; currently bits 3:0 are used for a 4-bit virtual TPR value; bits 7:4 are SBZ. <i>NOTE: This value is written back to the VMCB at #VMEXIT.</i>
	8	V_IRQ—If nonzero, virtual INTR is pending. <i>NOTE: This value is written back to the VMCB at #VMEXIT.</i>
	15–9	RESERVED, SBZ
	19–16	V_INTR_Prio—Priority for virtual interrupt.
	20	V_IGN_TPR—If nonzero, the current virtual interrupts ignores the (virtual) TPR.
	23–21	RESERVED, SBZ
	24	V_INTR_MASKING—Virtualize masking of INTR interrupts (see “Virtualizing APIC.TPR” on page 393).
	31–25	RESERVED, SBZ
	39–32	V_INTR_VECTOR—Vector to use for this interrupt.
068h	0	INTERRUPT_SHADOW—Guest is in an interrupt shadow; (see “Interrupt Shadows” on page 395). <i>Note: This value is written back to the VMCB at #VMEXIT.</i>
	63–1	RESERVED, SBZ
070h	63–0	EXITCODE
078h	63–0	EXITINFO1
080h	63–0	EXITINFO2
088h	63–1	EXITINTINFO
090h	0	NP_ENABLE—Enable nested paging.
	63–1	RESERVED, SBZ
098h–0A7h	RESERVED, SBZ	
0A8h	63–0	EVENTINJ—Event injection (see “Event Injection” on page 391 for details).

Table B-1. VMCB Layout, Control Area (continued)

Byte Offset	Bit(s)	Function
0B0h	63–1	N_CR3—Nested page table CR3 to use for nested paging.
0B8h	0	LBR_VIRTUALIZATION_ENABLE 0—Do nothing. 1—Enable LBR virtualization.
	63–1	Reserved, SBZ.
All other fields up to 3FFh	RESERVED, SBZ	

The state-save area within the VMCB starts at offset 400h into the VMCB page; Table B-2 describes the fields within the state-save area; note that the table lists offsets *relative to the state-save area* (not the VMCB as a whole).

Table B-2. VMCB Layout, State Save Area

Offset	Size	Contents	Notes
000h	word	ES	selector
002h	word		attrib
004h	dword		limit
008h	qword		base
010h	word	CS	selector
012h	word		attrib
014h	dword		limit
018h	qword		base
020h	word	SS	selector
022h	word		attrib
024h	dword		limit
028h	qword		base
030h	word	DS	selector
032h	word		attrib
034h	dword		limit
038h	qword		base
040h	word	FS	selector
042h	word		attrib
044h	dword		limit
048h	qword		base

Table B-2. VMCB Layout, State Save Area (continued)

Offset	Size	Contents		Notes
050h	word	GS	selector	
052h	word		attrib	
054h	dword		limit	
058h	qword		base	
060h	word	GDTR	selector	reserved
062h	word		attrib	reserved
064h	dword		limit	Only lower 16 bits are implemented.
068h	qword		base	
070h	word	LDTR	selector	
072h	word		attrib	
074h	dword		limit	
078h	qword		base	
080h	word	IDTR	selector	reserved
082h	word		attrib	reserved
084h	dword		limit	Only lower 16 bits are implemented.
088h	qword		base	
090h	word	TR	selector	
092h	word		attrib	
094h	dword		limit	
098h	qword		base	
0A0h–0CAh		RESERVED		
0CBh	byte	CPL		If the guest is real-mode then the CPL is forced to 0; if the guest is virtual-mode then the CPL is forced to 3.
0CCh	dword	RESERVED		
0D0h	qword	EFER		
0D8h–147h		RESERVED		
148h	qword	CR4		
150h	qword	CR3		
158h	qword	CR0		
160h	qword	DR7		
168h	qword	DR6		
170h	qword	RFLAGS		
178h	qword	RIP		
180h–1D7h		RESERVED		
1D8h	qword	RSP		
1E0h–1F7h		RESERVED		

Table B-2. VMCB Layout, State Save Area (continued)

Offset	Size	Contents	Notes
1F8h	qword	RAX	
200h	qword	STAR	
208h	qword	LSTAR	
210h	qword	CSTAR	
218h	qword	SFMASK	
220h	qword	KernelGsBase	
228h	qword	SYSENTER_CS	
230h	qword	SYSENTER_ESP	
238h	qword	SYSENTER_EIP	
240h	qword	CR2	
248h–267h		RESERVED	
268h	qword	G_PAT	Guest PAT—only used if nested paging enabled.
270h	qword	DBGCTL	Guest DBGCTL MSR—only used if the LBR registers are virtualized.
278h	qword	BR_FROM	Guest LastBranchFromIP MSR—only used if the LBR registers are virtualized.
280h	qword	BR_TO	Guest LastBranchToIP MSR—only used if the LBR registers are virtualized.
288h	qword	LASTEXCPFROM	Guest LastExceptionFromIP MSR—Only used if the LBR registers are virtualized.
290h	qword	LASTEXCPTO	Guest LastExceptionToIP MSR—Only used if the LBR registers are virtualized.
298h to end of VMCB		RESERVED	

Appendix C SVM Intercept Exit Codes

When the VMRUN instruction exits (back to the host), an exit/reason code is stored in the EXITCODE field in the VMCB. The exit codes are defined in Table C-1. Intercept exit codes 0h–89h equal the bit position of the corresponding flag in the VMCB’s intercept vector.

Table C-1. SVM Intercept Codes

Code	Name	Cause
0h–Fh	VMEXIT_CR[0–15]_READ	read of CR 0 through 15, respectively
10h–1Fh	VMEXIT_CR[0–15]_WRITE	write of CR 0 through 15, respectively
20h–2Fh	VMEXIT_DR[0–15]_READ	read of DR 0 through 15, respectively
30h–3Fh	VMEXIT_DR[0–15]_WRITE	write of DR 0 through 15, respectively
40h–5Fh	VMEXIT_EXCP[0–31]	exception vector 0–31, respectively
60h	VMEXIT_INTR	physical INTR (maskable interrupt)
61h	VMEXIT_NMI	physical NMI
62h	VMEXIT_SMI	physical SMI (the EXITINFO1 field provides more information)
63h	VMEXIT_INIT	physical INIT
64h	VMEXIT_VINTR	virtual INTR
65h	VMEXIT_CR0_SEL_WRITE	write of CR0 that changed any bits other than CR0.TS or CR0.MP
66h	VMEXIT_IDTR_READ	read of IDTR
67h	VMEXIT_GDTR_READ	read of GDTR
68h	VMEXIT_LDTR_READ	read of LDTR
69h	VMEXIT_TR_READ	read of TR
6Ah	VMEXIT_IDTR_WRITE	write of IDTR
6Bh	VMEXIT_GDTR_WRITE	write of GDTR
6Ch	VMEXIT_LDTR_WRITE	write of LDTR
6Dh	VMEXIT_TR_WRITE	write of TR
6Eh	VMEXIT_RDTSC	RDTSC instruction
6Fh	VMEXIT_RDPMC	RDPMC instruction
70h	VMEXIT_PUSHF	PUSHF instruction
71h	VMEXIT_POPF	POPF instruction
72h	VMEXIT_CPUID	CPUID instruction
73h	VMEXIT_RSM	RSM instruction
74h	VMEXIT_IRET	IRET instruction
75h	VMEXIT_SWINT	software interrupt (INT n instructions)
76h	VMEXIT_INV	INVD instruction

Table C-1. SVM Intercept Codes (continued)

Code	Name	Cause
77h	VMEXIT_PAUSE	PAUSE instruction
78h	VMEXIT_HLT	HLT instruction
79h	VMEXIT_INVLPG	INVLPG instructions
7Ah	VMEXIT_INVLPGA	INVLPGA instruction
7Bh	VMEXIT_IOIO	IN or OUT accessing protected port (the EXITINFO1 field provides more information)
7Ch	VMEXIT_MSR	RDMSR or WRMSR access to protected MSR
7Dh	VMEXIT_TASK_SWITCH	task switch
7Eh	VMEXIT_FERR_FREEZE	FP legacy handling enabled, and processor is frozen in an x87/mmx instruction waiting for an interrupt
7Fh	VMEXIT_SHUTDOWN	Shutdown
80h	VMEXIT_VMRUN	VMRUN instruction
81h	VMEXIT_VMMCALL	VMMCALL instruction
82h	VMEXIT_VMLOAD	VMLOAD instruction
83h	VMEXIT_VMSAVE	VMSAVE instruction
84h	VMEXIT_STGI	STGI instruction
85h	VMEXIT_CLGI	CLGI instruction
86h	VMEXIT_SKINIT	SKINIT instruction
87h	VMEXIT_RDTSCP	RDTSCP instruction
88h	VMEXIT_ICEBP	ICEBP instruction
89h	VMEXIT_WBINVD	WBINVD instruction
8Ah	VMEXIT_MONITOR	MONITOR instruction
8Bh	VMEXIT_MWAIT	MWAIT instruction
8Ch	VMEXIT_MWAIT_CONDITIONAL	MWAIT instruction, if Monitor hardware is armed.
400h	VMEXIT_NPF	Nested paging: host-level page fault occurred (EXITINFO1 contains fault error code; EXITINFO2 contains the guest physical address causing the fault.)
-1	VMEXIT_INVALID	Invalid guest state in VMCB

Index

Symbols

#AC	221
#BP	212
#BR	213
#D	221, 223
#DB	211
#DE	211
#DF	214
#GP	218
#I	220, 223
#IA	220
#IS	221
#MC	222
#MF	220
#NM	214
#NP	217
#O	221, 223
#OF	213
#P	221, 223
#PF	219
#SS	218
#SX	419
#TS	216
#U	221, 223
#UD	213
#VMEXIT	370, 371
#XF	223
#Z	221, 223

Numerics

128-bit media instructions	
enabling	290
feature identification	289
MXCSR	291
saving state	295
XMM registers	28, 291
16-bit mode	xxix
1-Gbyte page	133
32-bit mode	xxix
64-bit media instructions	
causing #MF exception	293
feature identification	289
initializing	354, 355
MMX registers	292
saving state	295
64-bit mode	xxix, 13

A

A bit	80, 82, 137
A20 Masking	413
abort	206
AC bit	53
access checking	401
accessed (A)	
code segment	80
data segment	82
page-translation tables	137
address space identifier (ASID)	368, 389
address-breakpoint registers (DR0-DR3)	329
addressing	
RIP-relative	xxxiv
address-size prefix	31
ADDRV bit	263
Advanced Programmable Interrupt Controller (APIC)	425
alignment check (rFLAGS.AC)	53, 221
alignment mask (CR0.AM)	45, 221
alignment-check exception (#AC)	45, 53, 221
AM bit	45
AP startup sequence	419
APIC	425
base address	428
enable	428
error interrupts	436
internal error	426
registers	428
timer interrupt	433
version register	430
APIC.TPR	393
APIC.TPR virtualization	369
Application Processors (APs)	418
Arbitration	443
architecture differences	23
ARPL instruction	156
ASID	368, 389
attributes	76
available to software (AVL)	
descriptor	79
page-translation tables	138
AVL bit	79, 138
B	
B3–B0 bits	330
base address	73, 75, 78, 121, 129, 136
BD bit	330

benign exception.....	214	privilege checks.....	103
biased exponent.....	xxx	stack switch.....	106
BIST.....	349	stack switch, long mode.....	33, 107
Boot Strap CPU Core.....	428	canonical address form.....	4, 128
bootstrap processor.....	352	CD bit.....	45, 179
Bootstrap Processor (BSP).....	418	CD memory type.....	170
BOUND instruction.....	213	CLFLUSH.....	181, 400
bound-range exception (#BR).....	213	CLGI.....	380, 390
BR_FROM.....	399	CLI instruction.....	154
BR_TO.....	399	clock multiplier.....	350
branches.....	32	CLTS.....	153, 378
breakpoint.....	335	code segment.....	26, 69, 80
determining cause.....	337	64-bit mode.....	70
on address match.....	328, 338	accessed (A).....	80
on any instruction.....	328	conforming (C).....	80
on I/O.....	338	default-operand size (D).....	81
on instruction.....	337	ignored fields in 64-bit mode.....	86
on task switch.....	328, 340	long bit (L).....	26, 87
setting address.....	335	long mode.....	86
specifying address-match length.....	335	readable (R).....	80
breakpoint exception (#BP).....	212	type field.....	80
BS bit.....	330	coherency, cache.....	161
BT bit.....	330	commit.....	xxx
BTF bit.....	334	commit, instruction results.....	162
built-in self test (BIST).....	349	compatibility mode.....	xxx, 13
C		config space accesses.....	401
C bit.....	80	conforming (C), code segment.....	80
cache		consistency checks, long mode.....	359
control mechanisms.....	179	containerized SMM code.....	397
control precedence.....	180	contributory exception.....	214
enabling.....	353	control registers.....	29, 41
index.....	178	control transfer.....	98
invalidate.....	182	See also call gate and interrupt.	
line.....	161	call gate.....	102
offset.....	178	direct.....	98
organization.....	176	far, conforming code segment.....	100
self-modifying code.....	178	far, nonconforming code segment.....	98
set.....	177	interrupt to higher privilege.....	234
tag.....	178	interrupt to same privilege.....	233
way.....	177	parameters.....	106
writeback and invalidate.....	181	stack switch.....	106
cache disable (CD) bit.....	45, 179	control-transfer recording MSRs.....	334
cache disable (CD), memory type.....	170	coprocessor-segment-overflow exception.....	215
cache-coherency protocol.....	167	count field.....	92, 257
losing coherency.....	169	counter mask field.....	345
CALL		CPL.....	94, 371
See call gate and control transfer.		definition.....	94
call gate.....	84, 102	in call gate protection.....	103
count field.....	86	in data segment protection.....	95
count field, long mode.....	92	in interrupt to higher privilege.....	235
descriptor, long mode.....	32	in page protection.....	143
jump through.....	104	in protecting conforming CS.....	100
parameters.....	106	in protecting nonconforming CS.....	99
		in stack segment protection.....	97

privileged instructions	147	FS and GS	27, 70
SYSCALL, SYSRET assumptions	150	ignored fields in 64-bit mode	87
CPU watchdog timer register	259	long mode	87
CPUID.....	54, 61, 153, 379, 399	privilege checks	95
nested paging	413	type field.....	82
CR0.....	42, 370, 371	writable (W).....	82
alignment mask (AM).....	45, 221	DAZ bit.....	304
cache disable (CD)	45, 179	DBGCTL	399
emulate coprocessor (EM).....	44, 290	DE bit	48
extension type (ET)	44	DE exception	221, 223
monitor coprocessor (MP).....	43	debug	21, 418
not write-through (NW)	45, 179	See breakpoint and single-step.	
numeric error (NE)	44, 221	debug exception (#DB).....	52, 211, 337
paging enable (PG).....	45, 118	debug registers.....	29, 328
protection enable (PE).....	43, 64, 71	address-breakpoint registers (DR0-DR3)	329
task switched (TS).....	44, 153	control-transfer recording MSRs	334
write protect (WP).....	44, 144	debug-control MSR (DebugCtlMSR).....	333
CR1	50	debug-control register (DR7)	331
CR2	45, 220, 371	reserved (DR4, DR5)	329
CR3.....	25, 45, 46, 120, 128, 315, 370, 371, 406	debug-control MSR (DebugCtlMSR).....	333
non-PAE paging	120	debug-control register (DR7)	331
PAE paging	46, 120	DebugCtlMSR register	333, 459, 467
PAE paging, long mode.....	128	debugging extensions (CR4.DE).....	48
page-level cache disable (PCD)	121, 129	DEC instruction	34
page-level write-through (PWT)	121, 129	default operand size	
table-base address.....	121, 129	B bit, stack segment	83
CR4.....	47, 370, 371	D bit, code segment	81
debugging extensions (DE).....	48	D bit, data segment	83, 110
machine-check enable (MCE).....	49, 222	D/B bit, descriptor	79
OS #XF support (OSXMMEXCPT).....	223, 290	with expand down.....	111
OS FXSAVE/FXRSTOR support (OSFXSR).....	290	denormalized-operand exception (DE).....	221, 223
page-global enable (PGE)	49, 140	denormals-are-zeros (DAZ) mode	304
page-size extensions (PSE).....	48, 119, 123	descriptor	65, 77
performance counter enable (PCE).....	49, 154, 343	available to software (AVL)	79
physical-address extensions (PAE)	48, 119, 128	code segment.....	26
protected-mode virtual interrupts (PVI).....	48	data segment	26
time-stamp disable (TSD)	48, 154, 347	default operand size (D/B).....	79
virtual-8086 mode extensions (VME).....	47, 248	DPL.....	79, 95, 320
CR5–CR7	50	gate	27
CR8.....	50, 228	granularity (G).....	79
CR9–CR15.....	50	long mode	86
CS register	69, 371	present (P).....	79, 320
selector	370	S field.....	79, 320
CSTAR register	150, 461, 463	segment base	78
D		segment limit.....	78
D bit	81, 87, 137	system segment	27
D/B bit.....	79, 83	TSS	310
data prefetch, cache.....	181	type field.....	79, 320
data segment.....	26, 69, 81	descriptor table	65, 71
64-bit mode.....	70	global-descriptor table (GDT).....	67
accessed (A).....	82	interrupt-descriptor table (IDT).....	36
default operand size (D)	83	local-descriptor table (LDT)	67
expand down (E)	82	descriptor-table registers	26, 66
		64-bit mode.....	92

GDTR	72	fast FXSAVE/FXRSTOR (FFXSR)	56
IDTR	77	long mode active (LMA)	55, 358
LDTR	74	long mode enable (LME)	55, 358
DEV base address registers	405	no-execute enable (NXE)	56
DEV caching	400	system-call extension (SCE)	55
DEV capability block	402	EFER.SVME	369, 370
DEV register access	403	effective address	2, 25
DEV_BASE_HI/LO registers	403	effective address size	xxxii
DEV_CAP register	404	effective operand size	xxxii
DEV_CR register	404	EFLAGS	
DEV_DATA	402, 403	See rFLAGS.	
DEV_HDR	402	eFLAGS register	xxxvii
DEV_MAP registers	404, 405	EIP	
DEV_OP	402, 403	See rIP.	
DEVBASE registers	400	eIP register	xxxvii
device exclusion vector (DEV)	400	EIPV bit	258
device ID	400	element	xxxii
device-not-available exception (#NM)	43, 44, 214	EM bit	44, 354
differences (architectural)	23	emulate coprocessor (CR0.EM)	44, 290
direct referencing	xxx	EN bit	263, 345
dirty (D), page-translation tables	137	enabling SVM	369
displacement	31	endian byte-ordering	xxxix
displacements	xxx	End-of-Interrupt Register (EOI)	448
divide-by-zero-error exception (#DE)	211	environment	296
double quadword	xxxii	error code	
double-fault exception (#DF)	214	page fault	225
doubleword	xxxii	selector	225
DP field	304	ES register	70, 371
DPL	95	ES.SEL	371
data segment, 64-bit mode	88	ESP	
definition	95	See rSP.	
in call gate protection	103	ET bit	44
in data segment protection	95	event handler, definition	205
in interrupt stack switch	234	event injection	391
in interrupt to higher privilege	235	event mask field	345
in protecting conforming CS	100	EVENTINJ	391, 392
in protecting nonconforming CS	99	exception handler, definition	205
in stack segment protection	97	Exception intercept	
in stack switching	106	#DE	383
DPL field	79, 320	exception intercept	
DR0-DR3 registers	329	#AC	385
DR4, DR5 registers	329	#BP	384
DR6 register	329, 371	#BR	384
DR7 register	331, 371	#DB	383
DS field	304	#DF	384
DS register	69, 70, 371	#GP	385
DS.SEL	371	#MC	385
E		#MF	385
E bit	82, 345	#NM	384
eAX-eSP register	xxxvi	#NP	385
EFER register	29, 54, 370, 371, 461, 463	#OF	384
		#PF	385
		#SS	385
		#TS	384

#UD	384	FOP register	303
#XF	385	FPR registers	294, 296
vector 2	383, 384	FS and GS	27, 70
Vector 9	384	FS register	70
Exception Intercepts	383	FS.Base register	461, 463
exceptions	xxxi	FSAVE, FRSTOR instructions	296
abort	206	FSW register	292, 294, 296, 303
benign	214	FTW register	292, 294, 296, 303
contributory	214	FXSAVE, FXRSTOR instructions	36, 49, 300
definition of	205	32-bit memory image	303
definition of vector	208	64-bit memory image	302
differences in long mode	36	x87 tag word format	304
error code, page fault	225		
error code, selector	225	G	
fault	206	G bit	79, 138
floating-point priorities	227	G3–G0 bits	332
imprecise	206	gate descriptors	27
maskable 128-bit media floating point	207	call gate	84
maskable x87 floating point	207	DPL	95
masking during stack switches	207	ignored fields in long mode	90
precise	205	illegal types in long mode	90
priorities	226	interrupt gate	84
trap	206	long mode	90, 92
while in SMM	282	redefined types in long mode	90
exclusive state, MOESI	167	target-segment offset	85
EXITINFO1	381	target-segment selector	85
expand down (E)		task gate	84
data segment	82	trap gate	84
stack segment	82, 111	GD bit	332
exponent	xxx	GDT	71
extended family field	353	GDTR	72, 370, 371, 379
Extended Interrupts	436	GE bit	332
extended model field	353	general detect fault	211, 339
extension type (CR0.ET)	44	general-protection exception (#GP)	218
F		general-purpose registers (GPRs)	28
family field	353	GIF	390
far control transfer	98	global descriptor table (GDT)	67, 71
far return	33, 109	base address, 64-bit mode	73
fast FXSAVE/FXRSTOR	56	first entry	71
fault	206	limit check, long mode	73
FCW register	294, 296, 303	global descriptor-table register (GDTR)	72
feature identification	61	base address	73
FENCE	163	limit	73
FFXSR bit	56	loading	155
fill, cache-line	161	storing	155
first instruction	352	global interrupt flag (GIF)	390
flat segmentation	6, 9, 65	global page (G), page-translation tables	138
FLDENV, FSTENV instructions	300	global pages	49, 140
floating-point exception pending (#MF)	220	granularity (G), descriptor	79, 110
caused by 64-bit media instructions	293	GS register	70
floating-point exception priorities	227	GS.Base register	461, 463
flush	xxxi	guest mode	367
		Guest page tables (gPT)	407

H

halt	156
Hardware errata	453
HLT	156, 379
host	367
hypervisor	367

I

I/O interrupts	426
I/O Permissions Map	380
I/O privilege level field (rFLAGS.IOPL)	52
I/O space accesses	401
I/O, memory-mapped	197
I/O-permission bitmap	
in 32-bit TSS	315
in 64-bit TSS	318
I/O-permission bitmap (IOPB)	316
ICEBP	380
ID bit	54
IDT	76
IDTR	77, 370, 371, 379
IE exception	220, 223
IF bit	52, 252
IGN	xxxii
illegal state	370
immediate operand	31
imprecise exceptions and interrupts	206
IN/OUT	381
INC instruction	34
indirect	xxxii
inexact-result exception	221, 223
INIT	349, 395
initialization	349
initialization (INIT)	349
processor state	350
In-Service Register	444
instructions (system-management)	147
INT bit	345
INT3 instruction	212, 340
integer bit	305
intercept	369
Ferr_Freeze	387, 388
shutdown	388
task switch	387
Intercept Exit Codes	477
Interprocessor interrupt (IPI)	418, 438
INIT	418
Startup	418
Interrupt Control	427
interrupt descriptor table (IDT)	76
limit check, long mode	77

interrupt descriptor-table register (IDTR)	77
loading	155
storing	155
interrupt flag (rFLAGS.IF)	52, 154
interrupt gate	84, 241
IST field	91
interrupt handler, definition	205
interrupt intercept	386
INIT	387
INTR	386
NMI	386
SMI	386
virtual	387
interrupt redirection	239, 250
Interrupt Request Register	444
interrupt shadows	395
INTERRUPT_SHADOW	371
interrupt-descriptor table (IDT)	
index	205, 232, 242
protected mode	231
real-address mode	229
interrupt-redirection bitmap	316
interrupts	
definition of external	205
definition of software	205
definition of vector	208
differences in long mode	36
external	223
external maskable	207
external nonmaskable	207
external-interrupt priorities	228
imprecise	206
long mode summary	241
precise	205
priorities	226
returning from 64-bit mode	246
returns	238
software	223
stack alignment, long mode	244
stack pointer push, long mode	243
stack switch, long mode	37, 244
to higher privilege	234
to same privilege	233
while in SMM	282
interrupt-stack table (IST)	37, 91, 245
in 64-bit TSS	318
interrupt-vector table	229
INTn	379
INTn instruction	223, 340
INTO instruction	213
INV bit	345
invalid arithmetic-operand exception	220
invalid state, MOESI	167
invalidate page	390

- invalid-opcode exception (#UD)..... 34, 213
- invalid-operation exception (IE)..... 220, 223
- invalid-TSS exception (#TS)..... 216
- INVD 157, 182, 379
- INVLPG 379
- INVLPG instruction..... 140, 157
- INVLPGA..... 379, 390
- IOPB 315, 316
- IOPL 381
- IOPL field..... 52, 239
- IOPL-sensitive instruction 248
- IOPM 380
- IOPM_BASE_PA 380
- IORRBase registers..... 199, 462, 465
- IORRMask registers..... 200, 465
- IORRs, variable-range..... 199
- IOSPE 401
- IRET 379
 - less privilege 238
 - long mode..... 37, 246
 - same privilege 238
- IST field..... 91
- J**
- J bit 306
- jump
 - See call gate and control transfer.
- K**
- KernelGSbase register..... 152, 461, 463
- L**
- L bit..... 87
- L1 data cache 161
- L1 instruction cache..... 161
- L2 cache 161
- L3–L0 bits 331
- LAR instruction..... 156
- last branch record virtualization 398
- LastBranchFromIP..... 398, 399
- LastBranchFromIP register 459, 467
- LastBranchToIP..... 398
- LastBranchToIP register 459, 467
- LastExceptionFromIP 399
- LastExceptionToIP..... 399
- LASTEXCPFROM 399
- LASTEXCPTO 399
- LastIntFromIP register 459, 467
- LastIntToIP register 459, 467
- LBR bit..... 334
- LBR_VIRTUALIZATION_ENABLE..... 399
- LDT..... 73
 - selector field..... 315
- LDTR 74, 379
- LE bit..... 332
- Legacy Interrupts 426
- legacy mode xxxii, 14, 23
- legacy PAE mode 413
- legacy x86 xxxii
- LEN3–LEN0 bits 332
- LFENCE instruction..... 181
- LGDT 155, 379
- LIDT..... 155, 379
- limit 73, 76, 78, 310
- linear address..... 3
- Link field 315
- LINT0..... 435
- LINT1 435
- LLDT..... 155, 379
- LMA bit..... 55
- LME bit 55
- LMSW..... 153, 378, 379
- load ordering 181
- Local APIC 427
 - ID..... 430
 - interrupt masking..... 395, 449
- local descriptor table (LDT)..... 67, 73
 - base address, 64-bit mode..... 76
 - limit check, long mode 76
- local descriptor-table register (LDTR) 74
 - attributes 76
 - base address 75
 - hidden portion 74
 - LDT selector 75
 - limit..... 76
 - loading..... 155
 - storing 155
- Local Interrupts 431
- locality 139
- logging
 - unauthorized access 406
- logical address 2
- long attribute (L)
 - code segment..... 87
 - effect on D bit..... 87
- long mode xxxii, 12, 23
 - activating 359
 - consistency checks..... 359
 - differences from legacy mode 38
 - enabling 358
 - enabling versus activating..... 358
 - GDT requirements 357
 - IDT requirements..... 357
 - leaving 361

page translation-table requirements	358	near pointers.....	2
relocating descriptor tables	360	physical address.....	3
relocating page tables.....	360	real address	10
TSS requirements	358	RIP-relative address	31
use of CS.L and CS.D	359	segment offset	2
long mode active (EFER.LMA)	55, 358	virtual address	3
long mode enable (EFER.LME).....	55, 358	memory consistency	412
LSB	xxxii	memory management	5
lsb	xxxii	memory serialization	181
LSTAR register.....	150, 461, 463	memory system.....	159
LTR	155, 379	memory type.....	170
M		determining effective.....	191
M bit.....	306	memory types	
machine check		combining	411
error codes	262	memory-access ordering	
error sources	256	description	162
error-reporting address register (MCi_ADDR).....	264	read ordering	162
error-reporting control register (MCi_CTL).....	261	write ordering.....	163
error-reporting miscellaneous register (MCi_MISC).....	264	memory-mapped I/O	
error-reporting register banks.....	260	directing reads and writes to	197, 201
error-reporting status register (MCi_STATUS).....	261	memory-type range register (MTRR).....	29
global-capabilities register (MCG_CAP)	257	combined with PAT.....	196
global-control register (MCG_CTL).....	259	effect of paging cache controls.....	191
global-status register (MCG_STATUS)	258	effects with large page sizes.....	192
initialization	267	fixed range	185
machine check registers.....	256	identifying features	190
machine-check enable (CR4.MCE)	49, 222	initial value	353
machine-check exception (#MC).....	222	IORRBase	199
fatal	256	IORRMask.....	200
recoverable	256	MTRRcap	190
mask	xxxiii	MTRRdefType	190
masking		MTRRfix16K	186
definition of interrupt.....	205	MTRRfix4K	186
MBZ.....	xxxiii	MTRRfix64K	186
MCA error code field	262	MTRRphysBase	187
MCE bit	49	MTRRphysMask	188
MCG_CAP register.....	257, 459, 466	overlapping ranges	192
MCG_CTL register	259, 459, 466	type field, default	183
MCG_CTL_P bit	258	type field, extended	197
MCG_STATUS register.....	258, 459, 466	variable range	187
MCi_ADDR registers.....	264, 461, 466	variable range size and alignment.....	188
MCi_CTL registers	261, 460, 466	MFENCE instruction.....	181
MCi_MISC registers	461, 467	MISCV bit.....	263
MCi_STATUS registers	261, 461, 466	MMX registers.....	292
MCIP bit	258	model field	353
memory	159	model-specific error code field	263
memory addressing		model-specific registers (MSRs).....	29, 56, 154
canonical address form.....	4	control-transfer recording	334
effective address	2	debug extensions	60
linear address	3	debug-control MSR (DebugCtlMSR).....	333
logical address.....	2	FS.base	71
		GS.base.....	71
		initializing	355
		machine check.....	60, 256

memory typing	59, 184	N	
PAT	193	NE bit	44, 354
performance monitoring	60, 342	near branch	
SYSCFG	57	operand size, 64-bit mode	32
system linkage	58, 150	near control transfer	98
time-stamp counter	60, 346	near pointers	2
TOP_MEM	201	near return	109
TOP_MEM2	201	Nested page tables (hPT)	407
modes	11	nested paging	406
16-bit	xxix	nested task (rFLAGS.NT)	52, 325
32-bit	xxix	nestedtable walk	409
64-bit	xxix, 13	NEXT_RIP	370
compatibility	xxx, 13	NMI	212
legacy	xxxii, 14	NMI support	396
long	xxxii, 12	no-execute (NX)	
protected	xxxiv, 14	page protection	143
real	xxxiv, 4, 14	page-translation tables, bit in	138
virtual-8086	xxxvi, 14	nonmaskable interrupt exception (NMI)	212
modified state, MOESI	167	while in SMM	282
MOESI	167	non-PAE paging	120
moffset	xxxiii	CR3 format	120
monitor coprocessor (CR0.MP)	43	NOP instruction	34
MOV CRn instruction	153	not write-through (CR0.NW)	45, 179
MOV DRn instruction	154	NP_ENABLE	409
MOV TO CR0	379	NT bit	52
MOV TO/FROM CR0	378	null selector	68
MOV TO/FROM CRn	378	64-bit mode far return	110
MOV TO/FROM DRn	378	interrupt return from 64-bit mode	247
MOVSXD instruction	34	long mode interrupts	244, 246
MP bit	43, 354	long mode stack switch	108
MSB	xxxiii	numeric error (CR0.NE)	44, 221
msb	xxxiii	NW bit	45
MSR	xxxvii	NX bit	138, 143
MSR permissions map (MSRPM)	382	NXE bit	56
MSR_PROT	382	O	
MSRs	56	octword	xxxiii
MTRRcap register	190, 459, 464	OE exception	221, 223
MTRRdefType register	190, 460, 465	offset	xxxiii, 85
MTRRfix16K_n registers	186	operand-size prefix	30
MTRRfix4K_n registers	186	operating modes	11
MTRRfix64K_n registers	186, 460, 465	OS bit	345
MtrrFixDramEn bit	58, 198	OS FXSAVE/FXRSTOR support (CR4.OSFXSR)	290
MtrrFixDramModEn bit	58, 198	OS unmasked exception support (CR4.OSXMMEXCPT)	223, 290
MTRRphysBasen registers	187, 460, 464	OSFXSR bit	49
MTRRphysMaskn registers	188, 464	OS-visible workarounds (OSVW)	453
MTRRs	184, 411	OSVW ID	453
MtrrTom2En bit	58, 203	OSVW status	455
MtrrVarDramEn bit	58, 203	OSVW_ID_Length	455
multiprocessor issues	400	OSXMMEXCPT bit	49
MXCSR register	291		
field	304		
MXCSR_MASK field	304		

OVER bit	263	page directory entry (PDE)	120
overflow	xxxiii	page size (PS)	137
overflow exception (#OF)	213	page table entry (PTE)	120
overflow exception (OE)	221, 223	page-attribute table (PAT)	138
owned state, MOESI	167	page-directory pointer entry (PDPE)	25, 120, 125
P		page-level cache disable (PCD)	137
P bit	79, 136, 320	page-level write-through (PWT)	137
packed	xxxiii	page-map level-4 entry (PML4E)	25, 128
PAE	371	physical-page base address	136
PAE bit	48, 119	present (P)	136
PAE paging	25, 120	read/write (R/W)	137
CR3 format	46, 120	translation-table base address	136
CR3 format, long mode	128	user/supervisor (U/S)	137
legacy mode	124	paging	7, 25, 115
long mode	129	See also PAE paging and non-PAE paging.	
page directory	120	effect of segment protection	146
page size (PS)	119, 123, 125	protection across translation hierarchy	144
page directory pointer	120, 125	protection checks	142
page faults		supported translations	117
guest level	410	paging enable (CR0.PG)	45, 118
page size (PS), page-translation tables	137	activating long mode	118, 359
page splintering	413	parameter count field	86
page table	120	PAT	412
page translation	115	See page-attribute table (PAT).	
page-attribute table (PAT)	193	PAT bit	138
combined with MTRR	196	PAT register	193, 460, 465
effect on memory access	195	PAUSE	379
identifying support	195	PBi bits	334
indexing	194	PC bit	345
page-translation tables, bit in	138	PCC bit	263
Paged Real Mode	391	PCD bit	121, 129, 137
page-fault exception (#PF)	136, 143, 144, 219	PCE bit	49
page-fault virtual address	220	PDE	120
page-global enable (CR4.PGE)	49, 140	PDPE	120, 371, 413
page-level cache disable (PCD)	180	PE bit	43
CR3, bit in	121	PE exception	221, 223
page-translation tables, bit in	137	PerfCtrn registers	342, 462, 468
page-level write-through (PWT)	180	PerfEvtSeln registers	343, 462, 468
CR3, bit in	121	performance counter	154
page-translation tables, bit in	137	performance counter enable (CR4.PCE)	49, 154, 343
page-map level-4	128	Performance Monitor Counter Interrupts	435
page-size extensions (CR4.PSE)	25, 26, 48, 119, 123	performance optimization	22, 341
40-bit physical address support	119, 124	performance-monitoring counter	
unsupported in long mode	119	overflow	346
page-translation cache	139	PerfCtrn	342
page-translation tables	25	PerfEvtSeln	343
accessed (A)	137	starting and stopping	346
available to software (AVL)	138	PG bit	45, 118
dirty (D)	137	PGE bit	49
global page (G)	138	physical address	3, 24
hierarchy	117	as index into cache	178
no-execute	138	physical memory	4

- physical-address extensions (CR4.PAE) 25, 48, 119, 128
 activating long mode 119, 359
 See also PAE paging.
- POP instruction 154
- POPF 379
- precise exceptions and interrupts 205
- precision exception (PE) 221, 223
- PREFETCH instruction 181
- present (P)
 descriptor 79, 320
 page-translation tables 136
- principle of locality 139
- priorities, interrupt 226
- privilege level 94
- probe, cache 161, 168
 during cache disable 179
- processor feature identification (rFLAGS.ID) 54
- processor halt 156
- processor state 350
- protected mode xxxiv, 14, 370
 initial operating environment 356
- protected-mode virtual interrupts (CR4.PVI) 48
- protection checks
 adjusting RPL 156
 call gate 103
 checking access rights 156
 data segment 95
 direct call, conforming 100
 direct call, nonconforming 98
 enabling 64
 far return 109
 interrupt return 238
 interrupt to higher privilege 235
 limit check, 64-bit mode 110
 long mode changes 27
 long mode interrupt 244
 long mode interrupt return 246
 stack segment 96
 type check 112
 verifying read/write access 156
- protection domains 400
- protection enable (CR0.PE) 43, 64, 71
- PS bit 119, 137
- PSE bit 48
- PSE paging 25
- P-State 457
 control 457
 current limit register 457
 status register 458
- PTE 120
- PUSH instruction 154
- PUSHF 379
- PVI bit 48
- PWT bit 121, 129, 137
- ## Q
- quadword xxxiv
- ## R
- R bit 80
- R/W bit 137, 144
- R/W3–R/W0 bits 332
- r8–r15 xxxvii
- RAX 370, 371
- rAX–rSP xxxvii
- RAZ xxxiv
- RdMem, MTRR type field 58, 197
- RDMSR 56, 154, 382
- RDP field 304
- RDPMC 49, 343, 379
- RDPMC instruction 154
- RDTSR 48, 60, 154, 346, 379
- RDTSRCP 48, 60, 154, 346, 380
- read hit 161
- read miss 161
- read ordering 181
- read/write (R/W)
 page protection 144
 page-translation tables, bit in 137
- readable (R), code segment 80
- real address 10
- real address mode. See real mode
- real mode xxxiv, 4, 14
 initial operating environment 356
- registers
 See also entries for individual registers.
 128-bit media registers (XMM) 28
 address-breakpoint registers (DR0–DR3) 329
 control registers 29, 41
 control-transfer recording MSRs 334
 CR0 42
 CR2 220
 CR3 25, 46, 120, 128
 CR4 47
 CSTAR 150
 debug registers 29, 328
 debug-control MSR (DebugCtlMSR) 333
 debug-control register (DR7) 331
 debug-extension MSRs 60
 descriptor-table registers 26, 66
 eAX–eSP xxxvi
 EFER 29, 54
 eFLAGS xxxvii
 eIP xxxvii
 FPR 294, 296
 FS and GS 70
 FS.base 71

GDTR	72	XMM registers	291
GPRs	28	relative	xxxiv
GS.base	71	replacement, cache-line	161
IDTR	77	replicated state	408
IORRBase	199	reserved	xxxiv
IORRMask	200	reset	349
last x87 data pointer	294, 296, 304	processor state	350
last x87 instruction pointer	294, 296, 303	RESET# signal	349
LDTR	74	resume flag (rFLAGS.RF)	52, 211, 339
LSTAR	150	RET instruction	109
machine-check MSR	60	from 64-bit mode	110
MCG_CAP	257	long mode	33, 109
MCG_CTL	259	popping null selector, 64-bit mode	110
MCG_STATUS	258	stack switch	109
MCi_ADDR	264	retire, instruction	162
MCi_CTL	261	revision history	xxv
MCi_MISC	264	REX prefix	29
MCi_STATUS	261	RF bit	52
memory-type range register (MTRR)	29, 59, 184	RFLAGS	370, 371
MMX	292	rFLAGS	28, 50
model-specific registers (MSRs)	29	alignment check (AC)	53, 221
MTRR, fixed range	185	I/O privilege level field (IOPL)	52
MTRR, variable range	187	interrupt flag (IF)	52, 154
MTRRcap	190	nested task (NT)	52, 325
MTRRdefType	190	processor feature identification (ID)	54
MTRRfix16K	186	resume flag (RF)	52, 211, 339
MTRRfix4K	186	trap flag (TF)	51
MTRRfix64K	186	virtual interrupt (VIF)	53, 249
MTRRphysBase	187	virtual interrupt pending (VIP)	53, 249
MTRRphysMask	188	virtual-8086 mode (VM)	53
MXCSR	291	rFLAGS register	xxxviii
PAT	193	RIP	371
PerfCtrn	342	rIP	28
PerfEvtSeln	343	rIP register	xxxviii
performance-monitoring MSRs	60	RIP-relative address	31
r8–r15	xxxvii	RIP-relative addressing	xxxiv
rAX–rSP	xxxvii	RIPV bit	258
rFLAGS	xxxviii, 28, 50	RPL	68, 95, 310
rIP	xxxviii	adjusting	156
rSP	28	definition	95
segment registers	68	in call gate protection	104
STAR	150	in data segment protection	95
SYSCFG	57	in far return	109
SYSENTER_CS	152	in IRET instruction	238
SYSENTER_EIP	152	in protecting conforming CS	101
SYSENTER_ESP	152	in protecting nonconforming CS	99
system-linkage MSRs	58	in stack segment protection	97
task-priority register (CR8)	38, 50, 228	RSM	271, 286, 379
time-stamp counter	60, 346	RSP	370, 371
TOP_MEM	58, 201	rSP	28
TOP_MEM2	58, 201	call gate stack switch	106
x87 FCW	294, 296, 303	implicit reference	31
x87 floating-point processor state	294		
x87 FSW	292, 294, 296, 303		
x87 FTW	292, 294, 296, 303		
x87 opcode	294, 296, 303		

S

S bit.....	79, 320
SBZ.....	xxxv
SCE bit.....	55
secure initialization.....	406
secure loader (SL).....	414
secure loader (SL) image.....	414
secure loader block.....	415
secure MP initialization.....	418
security exception (#SX).....	414, 419
segment base.....	78
segment limit.....	78
segment offset.....	2
segment registers.....	66, 68
64-bit mode.....	70
accessing.....	155
hidden portion.....	69
initializing unused registers.....	68
segmentation.....	5, 26
64-bit mode.....	65
combining with paging.....	8
flat segmentation.....	6, 9, 65
multi-segmented model.....	64
segment-not-present exception (#NP).....	217
segment-override prefix.....	30
selector.....	66, 67, 68, 75, 85, 310
selector index.....	68
self-modifying code.....	178
SEOI Register.....	449, 450
serializing instructions.....	182
set.....	xxxv
SF exception.....	221
SFENCE instruction.....	181
SGDT.....	155, 379
shadow page tables (SPTs).....	389
shared state, MOESI.....	167
shut down.....	215
SIDT.....	155, 379
SIMD floating-point exception (#XF).....	49, 223, 290
single-step	
all instructions.....	328, 339
control-transfers.....	328, 341
SKINIT.....	380, 406, 414
SL abort.....	418
SLDT.....	155, 379
SMBASE register.....	273
SMI.....	271
external, synchronous.....	397
internal, synchronous.....	396
external, asynchronous.....	397
SMM.....	271
SMM interrupts.....	282
SMM revision identifier.....	278
SMM state-save area.....	274
SMM_CTL MSR.....	421
SMRAM.....	272
SMRAM state-save area.....	274
SMSW.....	378
SMSW instruction.....	153
specific EOI (SEOI).....	450
speculative execution.....	162
SPT.....	389
Spurious Interrupts.....	438
SS register.....	70, 371
SS.SEL.....	370
SSE.....	xxxv
SSE2.....	xxxv
SSE3.....	xxxv
stack exception (#SS).....	218
stack pointers	
in 32-bit TSS.....	315
in 64-bit TSS.....	317
stack segment.....	69, 81
64-bit mode.....	70
default operand size (D).....	83
expand down (E).....	82
privilege checks.....	96
stack switch	
call gate.....	106
call gate, long mode.....	33, 107
far return.....	109
interrupt.....	234
interrupt return.....	238
interrupt, long mode.....	37
stack-fault exception (SF).....	221
STAR register.....	150, 461, 463
state switch.....	368
status word.....	153
stepping ID field.....	353
STGI.....	380, 390
STI instruction.....	154
sticky bits.....	xxxv
store ordering.....	181
STR.....	379
STR instruction.....	155
supervisor page.....	143
SVM support.....	396
SWAPGS instruction.....	152
SYSCALL Flag Mask register.....	150
SYSCALL, SYSRET instructions.....	55, 150
SYSCFG register.....	57, 462, 465
MtrrFixDramEn.....	58, 198
MtrrFixDramModEn.....	58, 198
MtrrTom2En.....	203
MtrrVarDramEn.....	58, 203

SYSENTER, SYSEXIT instructions 152
 illegal in long mode 152
 SYSENTER_CS register 152, 459, 464
 SYSENTER_EIP register 152, 459, 464
 SYSENTER_ESP register 152, 459, 464
 system call and return 149
 system data structures 17
 system management interrupt (SMI) 271, 281, 396
 while in SMM 282
 system management mode (SMM) 15, 24, 396
 leaving 286
 long mode differences 271
 operating environment 281
 revision identifier 278
 saving processor state 283
 SMBASE register 273
 SMRAM 272
 state-save area, AMD64 architecture 274
 state-save area, legacy 277
 system registers 15
 system segment 27, 78, 83
 ignored fields in 64-bit mode 89
 illegal types in long mode 88
 long mode 88
 type field 83
 system-call extension (EFER.SCE) 55
 system-linkage MSRs 58, 150

T

T bit 315
 table indicator, selector 68
 tagged TLB 368
 task gate 84
 in task switching 323
 long mode 92
 Task Register (TR) 66
 task register (TR) 311
 loading 155
 selector 310
 storing 155
 task switch 307, 321
 disabled in long mode 38
 lazy context switch 44, 306
 nesting tasks 325
 preventing recursion 325
 task switched (CR0.TS) 44, 153
 task, execution space 307
 task-priority register (CR8) 38, 50, 228
 task-state segment (TSS)
 descriptor 310
 dynamic fields 315
 I/O-permission bitmap 315, 318
 interrupt-redirection bitmap 316

 interrupt-stack table 318
 legacy 32-bit 313
 link field 325
 software-defined fields 315
 stack pointers 315, 317
 static fields 315
 TF bit 51
 Thermal Sensor 426
 Thermal Sensor Interrupts 436
 TI bit 68, 310
 time-stamp counter 154, 346
 time-stamp disable (CR4.TSD) 48, 154, 347
 TLB 138, 139, 370, 371
 explicit invalidation 140, 157
 implicit invalidation 141
 TLB Control 389
 TLB flush 390
 TLB_CONTROL 390
 top of memory 201
 TOP_MEM register 58, 201, 462, 465
 TOP_MEM2 register 58, 201, 462, 465
 TPM 416
 TPR register 38, 50, 228
 TR register 308, 311, 379
 translation lookaside buffer (TLB) 139
 trap 206
 trap flag (rFLAGS.TF) 51
 trap gate 84, 241
 Trigger Mode Register 444
 Trusted Platform Module (TPM) 414
 trusted software 414
 TS bit 44
 TSC register 346, 459, 468
 TSD bit 48
 TSS xxxv, 308, 313
 TSS descriptor 308
 TSS selector 85, 308
 type check 112
 Type field 79, 311, 320

U

U/S bit 137, 143
 UC bit 263
 UC memory type 170
 UD2 instruction 213
 UE exception 221, 223
 uncacheable (UC), memory type 170
 uncacheable (UC-), memory type 193
 underflow xxxv
 underflow exception (UE) 221, 223
 unit mask field 345
 user page 143

user segment.....	77	WC memory type.....	170
user/supervisor (U/S)		WC+	412
page protection.....	143	world switch	367
page-translation tables, bit in	137	WP bit.....	44, 144
USR bit.....	345	WP memory type	170
V		writable (W), data segment	82
V_IGN_TPR	394	write buffer.....	161, 174
V_INTR_MASKING.....	393	emptying.....	174
V_INTR_PRIO.....	394	write hit.....	161
V_INTR_VECTOR	394	write miss.....	161
V_IRQ.....	371, 394	write ordering	163, 181
V_TPR	371, 393, 394	write protect (CR0.WP).....	44
VAL bit.....	264	page protection	144
Variable-range IORRs	199	write-back (WB), memory type.....	171
vector.....	xxxv	writeback, cache line	161
vector, interrupt	208	write-combining (WC), memory type	170
VERR instruction	156	write-combining buffer.....	161, 175
VERW instruction.....	156	emptying.....	175
VIF bit.....	53	write-protect (WP), memory type	170
VIP bit.....	53	write-through (WT), memory type.....	170
virtual #INTR.....	394	WrMem, MTRR type field.....	58, 197
virtual address	3, 24	WRMSR	56, 154, 382
virtual interrupt (rFLAGS.VIF).....	53, 249	WT memory type	170
virtual interrupt pending (rFLAGS.VIP)	53, 249	X	
virtual interrupts	52, 53, 247, 249, 368	x87 control word.....	294, 296, 303
virtual interrupts, protected mode	251	x87 data pointer register	294, 296, 304
virtual machine control block (VMCB).....	369	x87 environment	296
virtual machine monitor	367	x87 floating-point instructions	
virtual memory	3	feature identification	290
virtual-8086 mode.....	xxxvi, 14	initializing.....	353
interrupt to protected mode.....	239	processor state	294
interrupts	238	saving state.....	295
virtual-8086 mode (rFLAGS.VM).....	53	x87 floating-point state, initialization.....	351
virtual-8086 mode extensions (CR4.VME)	47, 248	x87 instruction pointer register	294, 296, 303
VM bit.....	53	x87 opcode register	294, 296, 303
VM_HSAVE_AREA.....	371	x87 status word.....	292, 294, 296, 303
VM_SAVE_PA MSR	422	x87 tag word.....	292, 294, 296, 303
VMCB	370	FXSAVE format	304
VME	248	XMM registers.....	291
VME bit.....	47, 239	Z	
VMLOAD.....	370, 380, 388	ZE exception	221, 223
VMM	367	zero extension.....	30, 31
VMMCALL	380, 391	zero-divide exception (ZE).....	221, 223
VMRUN	367, 369, 370, 380		
VMSAVE.....	370, 380, 388		
W			
W bit	82		
WAIT/FWAIT instruction	43		
WB memory type	171		
WBINVD.....	157, 181, 380		

